

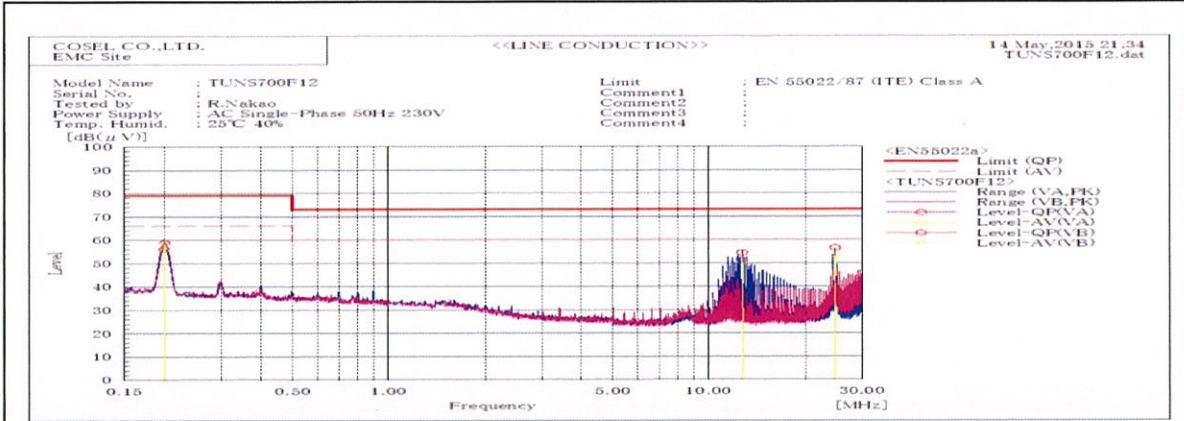

DATA SHEET		Date	25-May-15
Model	TUNS700F12	Temp.	25 degreeC
Test	EMI Line conduction & Radiated emission	Humid.	40 %RH
		Tested by	R.Nakao

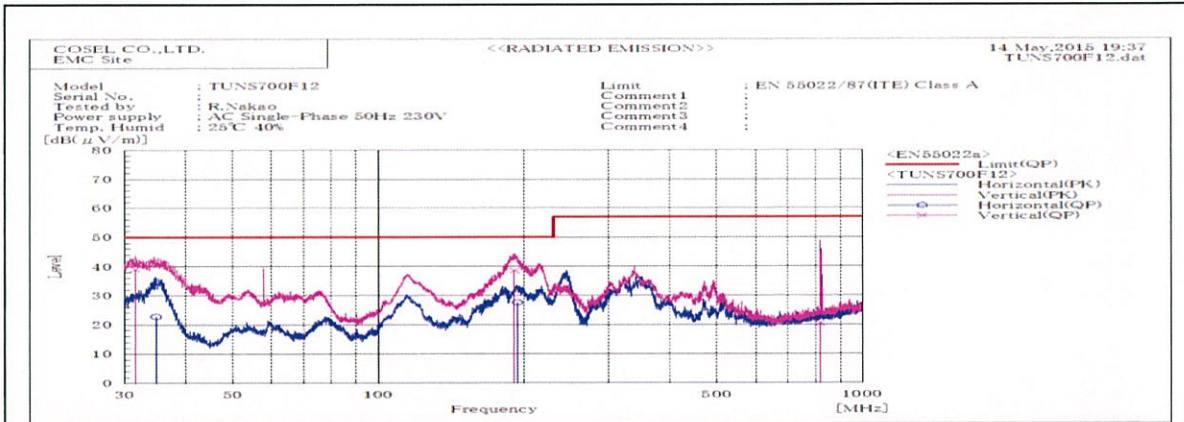

Frequency MHz	Harm	Line Phase	Reading dB(μV)		Factor dB	Level dB(μV)		Limit dB(μV)		Margin dB		Pass/ Fail	Remark
			QP	AV		QP	AV	QP	AV	QP	AV		
24.776		VB	35.6	32.2	20.9	56.5	53.1	73.0	60.0	16.5	6.9	Pass	
0.20057		VB	38.6	38.3	20.2	58.8	58.5	79.0	66.0	20.2	7.5	Pass	
12.69175		VA	33.7	29.6	20.7	54.4	50.3	73.0	60.0	18.6	9.7	Pass	
0.19967		VA	35.9	35.3	20.2	56.1	55.5	79.0	66.0	22.9	10.5	Pass	



Frequency MHz	Polarization	Stability	Reading dB(μV)		Space Loss	Level dB(mW)		Limit dB(mW)	Margin dB	Pass/Fail	Height cm	Angle deg	Remark
			QP	AV		QP	QP						
31.604	V	Stable	53.1	-14.0	39.1	50.0	10.9	Pass	112	153			
34.851	H	Stable	38.5	-15.6	22.9	50.0	27.1	Pass	140	208			
191.109	V	Stable	54.6	-15.9	38.7	50.0	11.3	Pass	108	87			
193.456	H	Stable	49.9	-22.3	27.6	50.0	22.4	Pass	157	318			
816.436	V	Stable	27.8	-7.3	20.5	57.0	36.5	Pass	155	339			

DATA SHEET		Date	25-May-15
Model	Circuit used for measurement	Temp.	25 degreeC
Test	EMI Line conduction & Radiated emission	Humid.	40 %RH
		Tested by	R.Nakao

1. Line conduction

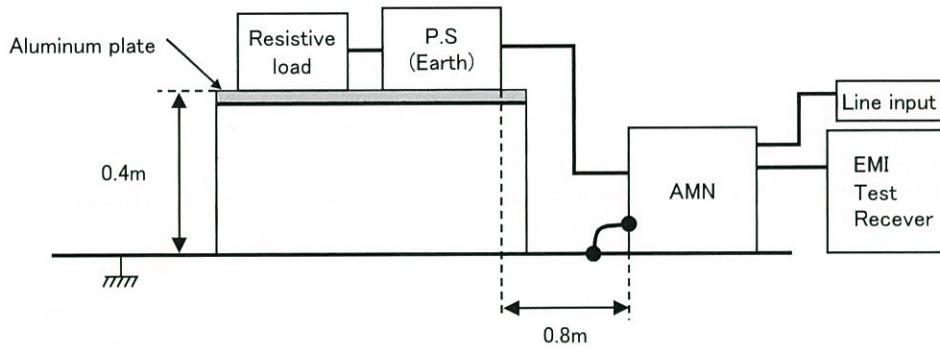

2. Radiated emission

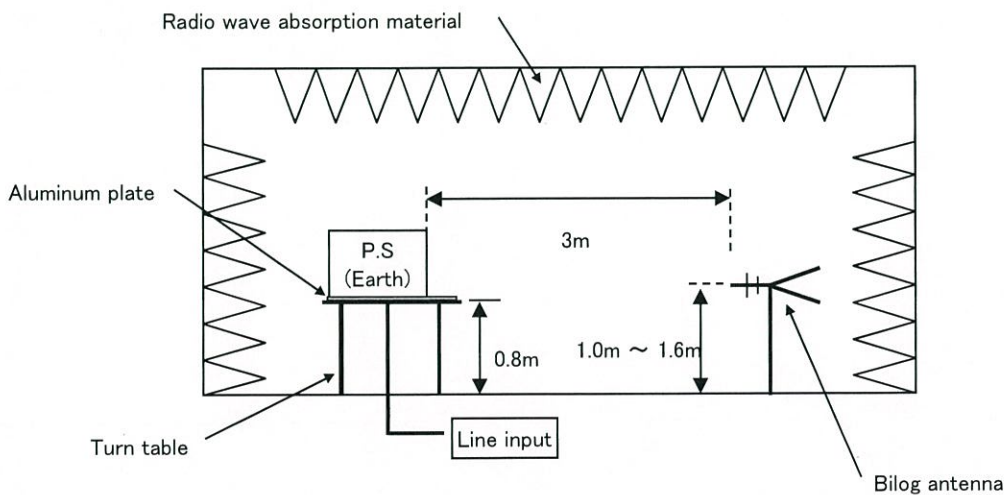



Test: EMI
Model Name:TUNS700F Series

○ Photographs of Test Set-Up

LINE CONDUCTION

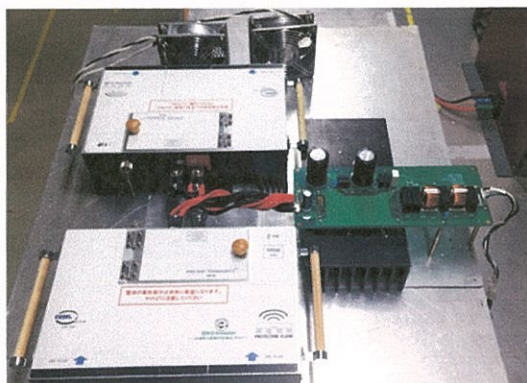

RADIATED EMISSION

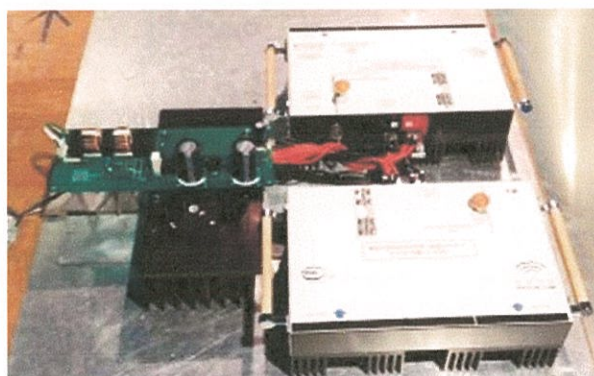

○ Test circuit

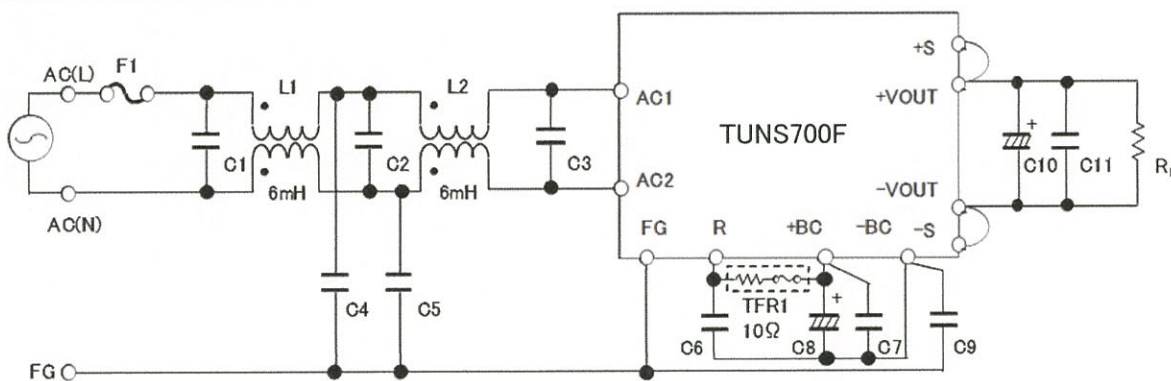

- | | |
|----------------------------------------------------------|-----------------------------------------------|
| L1,L2 : ADM-25-12-060T(Ueno) | C11 : TUNS700F12 10 μ F Ceramic Capacitor |
| C1,C2 : 1.5 μ F 275V Film Capacitor | TUNS700F28 4.7 μ F Ceramic Capacitor |
| C3 : 1.5 μ F 275V Film Capacitor \times 2 | TUNS700F48 2.2 μ F Ceramic Capacitor |
| C4,C5,C9 : 2200pF Ceramic Capacitor | |
| C6,C7 : 0.68 μ F 450V Film Capacitor \times 2 | |
| C8 : 390 μ F 450V Electrolytic Capacitor \times 2 | |
| C10 : TUNS700F12 2200 μ F 25V Electrolytic Capacitor | |
| TUNS700F28 1000 μ F 50V Electrolytic Capacitor | |
| TUNS700F48 470 μ F 63V Electrolytic Capacitor | |