



TEST DATA OF PAA75F-12 (100V INPUT)

Regulated DC Power Supply

Date : Feb. 17. 1997

Approved by : *M. Tanikawa*
Design Manager

Prepared by : *T. Amei*
Design Engineer

コーセル株式会社

COSEL CO., LTD.

CONTENTS

1.	Line Regulation	1
	静的入力変動	
2.	Efficiency	2
	効率	
3.	Power Factor	3
	力率	
4.	Hold-Up Time	4
	出力保持時間	
5.	Instantaneous Interruption Compensation	5
	瞬時停電保障	
6.	Load Regulation	6
	静的負荷変動	
7.	Ripple Voltage (by Load Current)	7
	リップル電圧(負荷電流特性)	
8.	Ripple-Noise	8
	リップルノイズ	
9.	Overcurrent Protection	9
	過電流保護	
10.	Overvoltage Protection	10
	過電圧保護	
11.	Inrush Current	11
	突入電流	
12.	Dynamic Load Responce	12
	動的負荷変動	
13.	Rise and Fall Time	13
	立上り、立下がり時間	
14.	Ambient Temperature Drift	14
	周囲温度変動	
15.	Minimum Input Voltage for Regulated Output Voltage	15
	最低レギュレーション電圧	
16.	Ripple Voltage (by Ambient Temperature)	16
	リップル電圧(周囲温度特性)	
17.	Time Lapse Drift	17
	経時ドリフト	
18.	Output Voltage Accuracy	18
	定電圧精度	
19.	Harmonic Current	19
	高調波電流	
20.	Condensation	21
	結露特性	
21.	Leakage Current	22
	漏洩電流	
22.	Line Noise Tolerance	23
	入力雑音耐量	
23.	Conducted Emission	24
	雑音端子電圧	
24.	Figure of Testing Circuitry	25
	測定回路図	

(Final Page 26)



<p>Model PAA75F-12</p>		<p>Temperature 25°C Testing Circuitry Figure A</p>																														
Item	Line Regulation 静的入力変動																															
Object	+12V6.3A																															
<p>1. Graph</p> <p>-----□----- Load 50% -----△----- Load 100%</p> <p>Note: Slanted line shows the range of the rated input voltage.</p> <p>(注) 斜線は定格入力電圧範囲を示す。</p>		<p>2. Values</p> <table border="1"> <thead> <tr> <th>Input Voltage [V]</th> <th>Load 50% Output Volt. [V]</th> <th>Load 100% Output Volt. [V]</th> </tr> </thead> <tbody> <tr><td>75</td><td>12.054</td><td>12.049</td></tr> <tr><td>80</td><td>12.054</td><td>12.049</td></tr> <tr><td>85</td><td>12.054</td><td>12.049</td></tr> <tr><td>90</td><td>12.054</td><td>12.049</td></tr> <tr><td>100</td><td>12.055</td><td>12.049</td></tr> <tr><td>110</td><td>12.055</td><td>12.049</td></tr> <tr><td>120</td><td>12.054</td><td>12.049</td></tr> <tr><td>132</td><td>12.055</td><td>12.049</td></tr> <tr><td>140</td><td>12.054</td><td>12.049</td></tr> </tbody> </table>	Input Voltage [V]	Load 50% Output Volt. [V]	Load 100% Output Volt. [V]	75	12.054	12.049	80	12.054	12.049	85	12.054	12.049	90	12.054	12.049	100	12.055	12.049	110	12.055	12.049	120	12.054	12.049	132	12.055	12.049	140	12.054	12.049
Input Voltage [V]	Load 50% Output Volt. [V]	Load 100% Output Volt. [V]																														
75	12.054	12.049																														
80	12.054	12.049																														
85	12.054	12.049																														
90	12.054	12.049																														
100	12.055	12.049																														
110	12.055	12.049																														
120	12.054	12.049																														
132	12.055	12.049																														
140	12.054	12.049																														



Model		PAA75F-12		Temperature 25°C																																	
Item		Efficiency 効率		Testing Circuitry Figure A																																	
Object		+12V6.3A																																			
1. Graph			2. Values																																		
<p>Efficiency [%]</p> <p>Input Voltage [V]</p> <p>Legend: □ Load 50% △ Load 100%</p>			<table border="1"> <thead> <tr> <th rowspan="2">Input Voltage [V]</th> <th>Load 50%</th> <th>Load 100%</th> </tr> <tr> <th>Efficiency [%]</th> <th>Efficiency [%]</th> </tr> </thead> <tbody> <tr><td>75</td><td>78.3</td><td>75.6</td></tr> <tr><td>80</td><td>78.5</td><td>76.3</td></tr> <tr><td>85</td><td>78.7</td><td>76.7</td></tr> <tr><td>90</td><td>78.6</td><td>77.1</td></tr> <tr><td>100</td><td>78.5</td><td>77.8</td></tr> <tr><td>110</td><td>78.5</td><td>78.1</td></tr> <tr><td>120</td><td>78.0</td><td>78.4</td></tr> <tr><td>132</td><td>77.5</td><td>78.6</td></tr> <tr><td>140</td><td>77.5</td><td>78.7</td></tr> </tbody> </table>			Input Voltage [V]	Load 50%	Load 100%	Efficiency [%]	Efficiency [%]	75	78.3	75.6	80	78.5	76.3	85	78.7	76.7	90	78.6	77.1	100	78.5	77.8	110	78.5	78.1	120	78.0	78.4	132	77.5	78.6	140	77.5	78.7
Input Voltage [V]	Load 50%	Load 100%																																			
	Efficiency [%]	Efficiency [%]																																			
75	78.3	75.6																																			
80	78.5	76.3																																			
85	78.7	76.7																																			
90	78.6	77.1																																			
100	78.5	77.8																																			
110	78.5	78.1																																			
120	78.0	78.4																																			
132	77.5	78.6																																			
140	77.5	78.7																																			
<p>Note: Slanted line shows the range of the rated input voltage.</p> <p>(注) 斜線は定格入力電圧範囲を示す。</p>																																					



Model	PAA75F-12
Item	Power Factor 力率
Object	+12V6.3A

Temperature 25°C
Testing Circuitry Figure A

1. Graph

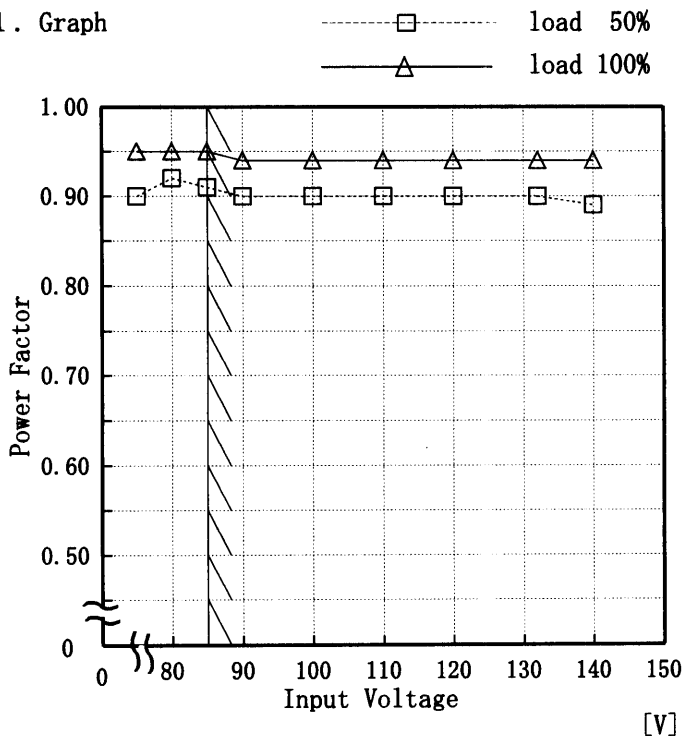

2. Values

Input Voltage [V]	load 50%	load 100%
	Power Factor	Power Factor
75	0.90	0.95
80	0.92	0.95
85	0.91	0.95
90	0.90	0.94
100	0.90	0.94
110	0.90	0.94
120	0.90	0.94
132	0.90	0.94
140	0.89	0.94

Note: Slanted line shows the range of the rated input voltage.

(注) 斜線は定格入力電圧範囲を示す。



Model		PAA75F-12		Temperature		25°C																																	
Item		Hold-Up Time 出力保持時間		Testing Circuitry		Figure A																																	
Object		+12V6.3A																																					
1. Graph				2. Values																																			
<p> △ Load 50% □ Load 100% </p> <p> This duration covers from Shut-off of input voltage to the moment when output voltage descends to the rated range of voltage accuracy. Note: Slanted line shows the range of the rated input voltage. </p> <p>出力保持時間とは、入力電圧断から出力電圧が、定電圧精度の規格範囲を保持しているところまでの時間。 (注)斜線は定格入力電圧範囲を示す。</p>				<table border="1"> <thead> <tr> <th rowspan="2">Input Voltage [V]</th> <th>Load 50%</th> <th>Load 100%</th> </tr> <tr> <th>Hold-Up Time [mS]</th> <th>Hold-Up Time [mS]</th> </tr> </thead> <tbody> <tr><td>75</td><td>33</td><td>9</td></tr> <tr><td>80</td><td>39</td><td>11</td></tr> <tr><td>85</td><td>46</td><td>13</td></tr> <tr><td>90</td><td>54</td><td>17</td></tr> <tr><td>100</td><td>68</td><td>22</td></tr> <tr><td>110</td><td>89</td><td>28</td></tr> <tr><td>120</td><td>106</td><td>36</td></tr> <tr><td>132</td><td>126</td><td>45</td></tr> <tr><td>140</td><td>149</td><td>51</td></tr> </tbody> </table>				Input Voltage [V]	Load 50%	Load 100%	Hold-Up Time [mS]	Hold-Up Time [mS]	75	33	9	80	39	11	85	46	13	90	54	17	100	68	22	110	89	28	120	106	36	132	126	45	140	149	51
Input Voltage [V]	Load 50%	Load 100%																																					
	Hold-Up Time [mS]	Hold-Up Time [mS]																																					
75	33	9																																					
80	39	11																																					
85	46	13																																					
90	54	17																																					
100	68	22																																					
110	89	28																																					
120	106	36																																					
132	126	45																																					
140	149	51																																					



Model		PAA75F-12		Temperature		25°C																																																				
Item		Instantaneous Interruption Compensation 瞬時停電保障		Testing Circuitry		Figure A																																																				
Object		+12V6.3A																																																								
<p>1. Graph</p> <p>—△— Input Volt. 85V - -□- - Input Volt. 100V - -○- - Input Volt. 132V</p> <p>This duration counts between Shut-off and on of input voltage automatically. Note: Slanted line shows the range of the rated load current.</p> <p>瞬時停電保障時間とは、出力電圧が定格値の95%になる時の瞬時停電時間をいう。 (注)斜線は定格負荷電流範囲を示す。</p>				<p>2. Values</p> <table border="1"> <thead> <tr> <th rowspan="2">Load Current [A]</th> <th>Input Volt. 85[V]</th> <th>Input Volt. 100[V]</th> <th>Input Volt. 132[V]</th> </tr> <tr> <th colspan="3">Time [mS]</th> </tr> </thead> <tbody> <tr><td>0.0</td><td>—</td><td>—</td><td>—</td></tr> <tr><td>1.0</td><td>190</td><td>262</td><td>584</td></tr> <tr><td>2.0</td><td>78</td><td>112</td><td>212</td></tr> <tr><td>3.0</td><td>42</td><td>62</td><td>118</td></tr> <tr><td>4.0</td><td>30</td><td>40</td><td>80</td></tr> <tr><td>5.0</td><td>20</td><td>28</td><td>53</td></tr> <tr><td>6.0</td><td>13</td><td>20</td><td>42</td></tr> <tr><td>6.3</td><td>11</td><td>16</td><td>35</td></tr> <tr><td>—</td><td>—</td><td>—</td><td>—</td></tr> <tr><td>—</td><td>—</td><td>—</td><td>—</td></tr> <tr><td>—</td><td>—</td><td>—</td><td>—</td></tr> </tbody> </table>				Load Current [A]	Input Volt. 85[V]	Input Volt. 100[V]	Input Volt. 132[V]	Time [mS]			0.0	—	—	—	1.0	190	262	584	2.0	78	112	212	3.0	42	62	118	4.0	30	40	80	5.0	20	28	53	6.0	13	20	42	6.3	11	16	35	—	—	—	—	—	—	—	—	—	—	—	—
Load Current [A]	Input Volt. 85[V]	Input Volt. 100[V]	Input Volt. 132[V]																																																							
	Time [mS]																																																									
0.0	—	—	—																																																							
1.0	190	262	584																																																							
2.0	78	112	212																																																							
3.0	42	62	118																																																							
4.0	30	40	80																																																							
5.0	20	28	53																																																							
6.0	13	20	42																																																							
6.3	11	16	35																																																							
—	—	—	—																																																							
—	—	—	—																																																							
—	—	—	—																																																							



Model		PAA75F-12		Temperature		25°C																																																
Item		Load Regulation 静的負荷変動		Testing Circuitry		Figure A																																																
Object		+12V6.3A																																																				
1. Graph				2. Values																																																		
<p> <input type="checkbox"/>—△— Input Volt. 85V <input type="checkbox"/>- - -□- - - Input Volt. 100V <input type="checkbox"/>- - -○- - - Input Volt. 132V </p>				<table border="1"> <thead> <tr> <th rowspan="2">Load Current [A]</th> <th>Input Volt. 85[V]</th> <th>Input Volt. 100[V]</th> <th>Input Volt. 132[V]</th> </tr> <tr> <th>Output Volt. [V]</th> <th>Output Volt. [V]</th> <th>Output Volt. [V]</th> </tr> </thead> <tbody> <tr><td>0.0</td><td>12.061</td><td>12.060</td><td>12.060</td></tr> <tr><td>1.0</td><td>12.059</td><td>12.059</td><td>12.059</td></tr> <tr><td>2.0</td><td>12.057</td><td>12.057</td><td>12.057</td></tr> <tr><td>3.0</td><td>12.055</td><td>12.055</td><td>12.055</td></tr> <tr><td>4.0</td><td>12.053</td><td>12.053</td><td>12.053</td></tr> <tr><td>5.0</td><td>12.052</td><td>12.052</td><td>12.051</td></tr> <tr><td>6.0</td><td>12.050</td><td>12.050</td><td>12.050</td></tr> <tr><td>6.3</td><td>12.049</td><td>12.049</td><td>12.049</td></tr> <tr><td>6.9</td><td>12.048</td><td>12.048</td><td>12.048</td></tr> <tr><td>—</td><td>—</td><td>—</td><td>—</td></tr> </tbody> </table>				Load Current [A]	Input Volt. 85[V]	Input Volt. 100[V]	Input Volt. 132[V]	Output Volt. [V]	Output Volt. [V]	Output Volt. [V]	0.0	12.061	12.060	12.060	1.0	12.059	12.059	12.059	2.0	12.057	12.057	12.057	3.0	12.055	12.055	12.055	4.0	12.053	12.053	12.053	5.0	12.052	12.052	12.051	6.0	12.050	12.050	12.050	6.3	12.049	12.049	12.049	6.9	12.048	12.048	12.048	—	—	—	—
Load Current [A]	Input Volt. 85[V]	Input Volt. 100[V]	Input Volt. 132[V]																																																			
	Output Volt. [V]	Output Volt. [V]	Output Volt. [V]																																																			
0.0	12.061	12.060	12.060																																																			
1.0	12.059	12.059	12.059																																																			
2.0	12.057	12.057	12.057																																																			
3.0	12.055	12.055	12.055																																																			
4.0	12.053	12.053	12.053																																																			
5.0	12.052	12.052	12.051																																																			
6.0	12.050	12.050	12.050																																																			
6.3	12.049	12.049	12.049																																																			
6.9	12.048	12.048	12.048																																																			
—	—	—	—																																																			
<p>Note: Slanted line shows the range of the rated load current.</p> <p>(注)斜線は定格負荷電流範囲を示す。</p>																																																						



<p>Model PAA75F-12</p> <p>Item Ripple Voltage (by Load Current) リップル電圧 (負荷電流特性)</p> <p>Object +12V6.3A</p>		<p>Temperature 25°C</p> <p>Testing Circuitry Figure A</p>																																						
<p>1. Graph</p> <p>[mV]</p> <p>-----□----- Input Volt. 85V</p> <p>-----△----- Input Volt. 132V</p> <p>Ripple Voltage</p> <p>Load Current [A]</p>		<p>2. Values</p> <table border="1"> <thead> <tr> <th rowspan="2">Load Current [A]</th> <th>Input Volt. 85 [V]</th> <th>Input Volt. 132 [V]</th> </tr> <tr> <th>Ripple Output Volt. [mV]</th> <th>Ripple Output Volt. [mV]</th> </tr> </thead> <tbody> <tr><td>0.0</td><td>10</td><td>10</td></tr> <tr><td>1.0</td><td>30</td><td>30</td></tr> <tr><td>2.0</td><td>30</td><td>30</td></tr> <tr><td>3.0</td><td>30</td><td>30</td></tr> <tr><td>4.0</td><td>30</td><td>30</td></tr> <tr><td>5.0</td><td>40</td><td>40</td></tr> <tr><td>6.0</td><td>40</td><td>40</td></tr> <tr><td>6.3</td><td>40</td><td>40</td></tr> <tr><td>7.0</td><td>40</td><td>40</td></tr> <tr><td>—</td><td>—</td><td>—</td></tr> <tr><td>—</td><td>—</td><td>—</td></tr> </tbody> </table>	Load Current [A]	Input Volt. 85 [V]	Input Volt. 132 [V]	Ripple Output Volt. [mV]	Ripple Output Volt. [mV]	0.0	10	10	1.0	30	30	2.0	30	30	3.0	30	30	4.0	30	30	5.0	40	40	6.0	40	40	6.3	40	40	7.0	40	40	—	—	—	—	—	—
Load Current [A]	Input Volt. 85 [V]	Input Volt. 132 [V]																																						
	Ripple Output Volt. [mV]	Ripple Output Volt. [mV]																																						
0.0	10	10																																						
1.0	30	30																																						
2.0	30	30																																						
3.0	30	30																																						
4.0	30	30																																						
5.0	40	40																																						
6.0	40	40																																						
6.3	40	40																																						
7.0	40	40																																						
—	—	—																																						
—	—	—																																						
<p>Ripple Voltage is shown as p-p in the figure below.</p> <p>Note: Slanted line shows the range of the rated load current.</p> <p>リップル電圧は、下図 p-p 値で示される。 (注) 斜線は定格負荷電流範囲を示す。</p> <p>T1: Due to AC Input Line 入力商用周期</p> <p>T2: Due to Switching スイッチング周期</p> <p>Ripple [mVp-p]</p> <p>T1</p> <p>T2</p>																																								
<p>Fig. Complex Ripple Wave Form</p> <p>☒ リップル波形詳細図</p>																																								



Model		PAA75F-12		Temperature		1°C																																							
Item		Ripple-Noise リップルノイズ		Testing Circuitry		Figure A																																							
Object		+12V6.3A																																											
<p>1. Graph</p> <p>[mV]</p> <p>-----□----- Input Volt. 85V</p> <p>-----△----- Input Volt. 132V</p> <p>Ripple-Noise is shown as p-p in the figure below. Note: Slanted line shows the range of the rated load current.</p> <p>リップルノイズは、下図 p-p 値で示される。 (注) 斜線は定格負荷電流範囲を示す。</p>				<p>2. Values</p> <table border="1"> <thead> <tr> <th rowspan="2">Load current [A]</th> <th>Input Volt. 85 [V]</th> <th>Input Volt. 132 [V]</th> </tr> <tr> <th>Ripple-Noise [mV]</th> <th>Ripple-Noise [mV]</th> </tr> </thead> <tbody> <tr><td>0.0</td><td>10</td><td>10</td></tr> <tr><td>1.0</td><td>30</td><td>30</td></tr> <tr><td>2.0</td><td>30</td><td>30</td></tr> <tr><td>3.0</td><td>40</td><td>40</td></tr> <tr><td>4.0</td><td>40</td><td>40</td></tr> <tr><td>5.0</td><td>50</td><td>50</td></tr> <tr><td>6.0</td><td>50</td><td>50</td></tr> <tr><td>6.3</td><td>50</td><td>50</td></tr> <tr><td>7.0</td><td>50</td><td>50</td></tr> <tr><td>—</td><td>—</td><td>—</td></tr> <tr><td>—</td><td>—</td><td>—</td></tr> </tbody> </table>				Load current [A]	Input Volt. 85 [V]	Input Volt. 132 [V]	Ripple-Noise [mV]	Ripple-Noise [mV]	0.0	10	10	1.0	30	30	2.0	30	30	3.0	40	40	4.0	40	40	5.0	50	50	6.0	50	50	6.3	50	50	7.0	50	50	—	—	—	—	—	—
Load current [A]	Input Volt. 85 [V]	Input Volt. 132 [V]																																											
	Ripple-Noise [mV]	Ripple-Noise [mV]																																											
0.0	10	10																																											
1.0	30	30																																											
2.0	30	30																																											
3.0	40	40																																											
4.0	40	40																																											
5.0	50	50																																											
6.0	50	50																																											
6.3	50	50																																											
7.0	50	50																																											
—	—	—																																											
—	—	—																																											
<p>T1: Due to AC Input Line 入力商用周期</p> <p>T2: Due to Switching スイッチング周期</p> <p>Fig. Complex Ripple Wave Form 図 リップル波形詳細図</p>																																													

COSEL

Model PAA75F-12		Temperature 25°C Testing Circuitry Figure A																																																							
Item Overcurrent Protection 過電流保護																																																									
Object +12V6.3A																																																									
<p>1. Graph</p> <p>[V]</p> <p>----- Input Volt. 85 V _____ Input Volt. 100 V _____ Input Volt. 132 V</p> <p>Output Voltage [V]</p> <p>Load Current [A]</p>		<p>2. Values</p> <table border="1"> <thead> <tr> <th rowspan="2">Output Voltage [V]</th> <th>Input Volt. 85[V]</th> <th>Input Volt. 100[V]</th> <th>Input Volt. 132[V]</th> </tr> <tr> <th>Load Current [A]</th> <th>Load Current [A]</th> <th>Load Current [A]</th> </tr> </thead> <tbody> <tr><td>12.00</td><td>8.50</td><td>8.30</td><td>7.88</td></tr> <tr><td>11.40</td><td>8.50</td><td>8.33</td><td>7.91</td></tr> <tr><td>10.80</td><td>8.51</td><td>8.35</td><td>7.96</td></tr> <tr><td>9.60</td><td>8.56</td><td>8.40</td><td>8.04</td></tr> <tr><td>8.40</td><td>8.67</td><td>8.46</td><td>8.15</td></tr> <tr><td>7.20</td><td>8.74</td><td>8.53</td><td>8.27</td></tr> <tr><td>6.00</td><td>8.80</td><td>8.65</td><td>8.41</td></tr> <tr><td>4.80</td><td>8.90</td><td>8.78</td><td>8.51</td></tr> <tr><td>3.60</td><td>9.04</td><td>8.93</td><td>8.67</td></tr> <tr><td>2.40</td><td>9.25</td><td>9.14</td><td>8.86</td></tr> <tr><td>1.20</td><td>9.59</td><td>9.48</td><td>9.21</td></tr> <tr><td>0.00</td><td>10.15</td><td>10.00</td><td>9.63</td></tr> </tbody> </table>	Output Voltage [V]	Input Volt. 85[V]	Input Volt. 100[V]	Input Volt. 132[V]	Load Current [A]	Load Current [A]	Load Current [A]	12.00	8.50	8.30	7.88	11.40	8.50	8.33	7.91	10.80	8.51	8.35	7.96	9.60	8.56	8.40	8.04	8.40	8.67	8.46	8.15	7.20	8.74	8.53	8.27	6.00	8.80	8.65	8.41	4.80	8.90	8.78	8.51	3.60	9.04	8.93	8.67	2.40	9.25	9.14	8.86	1.20	9.59	9.48	9.21	0.00	10.15	10.00	9.63
Output Voltage [V]	Input Volt. 85[V]	Input Volt. 100[V]		Input Volt. 132[V]																																																					
	Load Current [A]	Load Current [A]	Load Current [A]																																																						
12.00	8.50	8.30	7.88																																																						
11.40	8.50	8.33	7.91																																																						
10.80	8.51	8.35	7.96																																																						
9.60	8.56	8.40	8.04																																																						
8.40	8.67	8.46	8.15																																																						
7.20	8.74	8.53	8.27																																																						
6.00	8.80	8.65	8.41																																																						
4.80	8.90	8.78	8.51																																																						
3.60	9.04	8.93	8.67																																																						
2.40	9.25	9.14	8.86																																																						
1.20	9.59	9.48	9.21																																																						
0.00	10.15	10.00	9.63																																																						
<p>Note: Slanted line shows the range of the rated load current.</p> <p>(注)斜線は定格負荷電流範囲を示す。</p>																																																									



Model	PAA75F-12
Item	Overvoltage Protection 過電圧保護
Object	+12V6.3A

Testing Circuitry Figure A

1. Graph

- △— Input Volt. 85 V
- - -□- - - Input Volt. 100 V
- - -○- - - Input Volt. 132 V

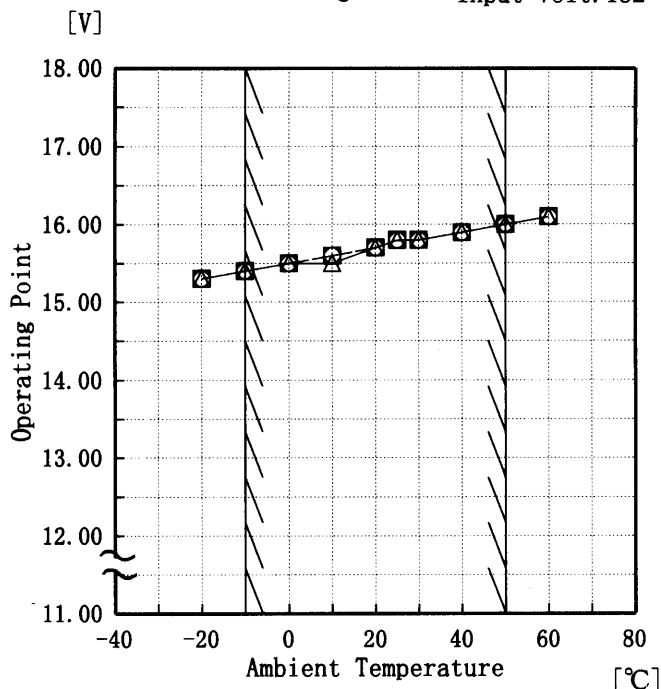

Note: Slanted line shows the range of the rated ambient temperature.

(注)斜線は定格周囲温度範囲を示す。

2. Values

Ambient Temp. [°C]	Input Volt. 85[V]	Input Volt. 100[V]	Input Volt. 132[V]
	Operating Point [V]		
-20	15.3	15.3	15.3
-10	15.4	15.4	15.4
0	15.5	15.5	15.5
10	15.5	15.6	15.6
20	15.7	15.7	15.7
25	15.8	15.8	15.8
30	15.8	15.8	15.8
40	15.9	15.9	15.9
50	16.0	16.0	16.0
60	16.1	16.1	16.1
—	—	—	—

COSEL

Model	PAA75F-12	Temperature	25°C
Item	Inrush Current 突入電流	Testing Circuitry	Figure A
Object	+12V6.3A		

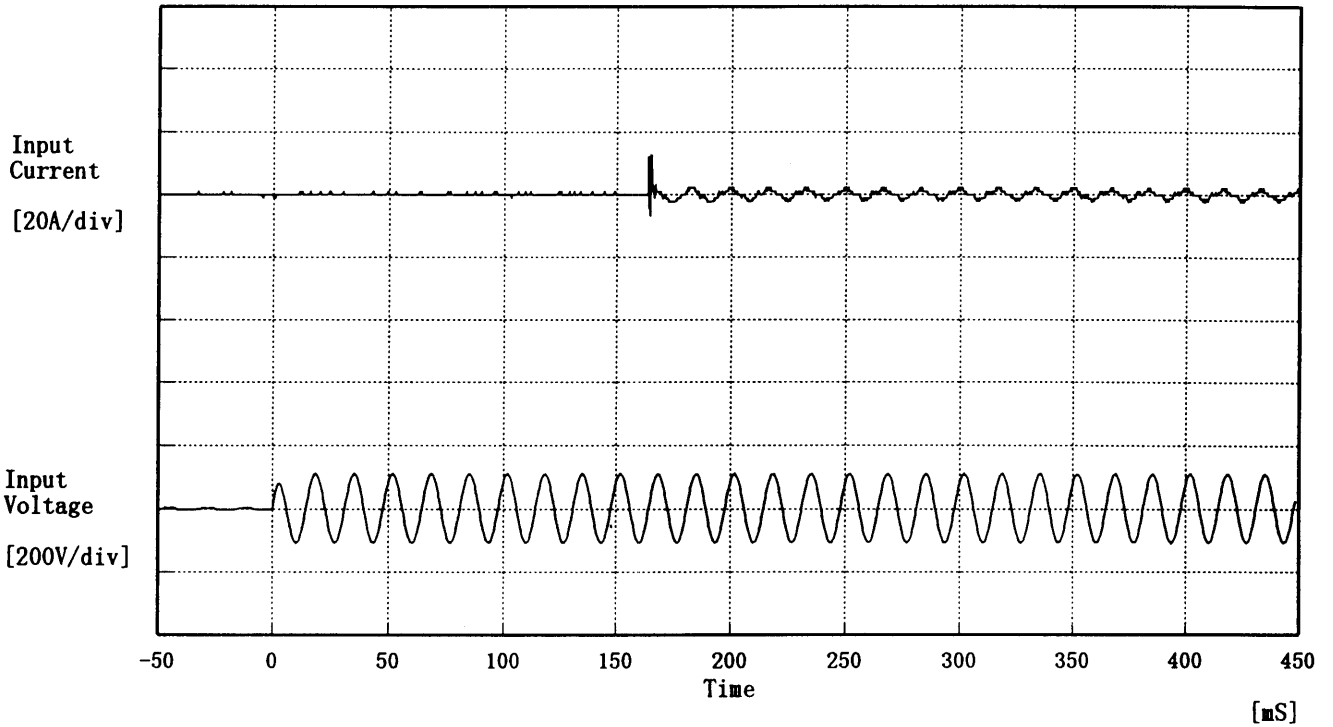

Input Voltage 100 V
 Frequency 60 Hz
 Load 100 %
 Inrush Current
 ① 1.13 [A]
 ② 17.02 [A]

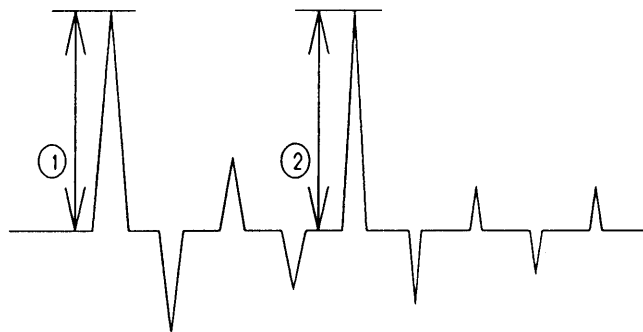



Model PAA75F-12		Temperature 25°C Testing Circuitry Figure A
Item	Dynamic Load Responce 動的負荷変動	
Object	+12V6.3A	

Input Volt. 100 V
Cycle 200 mS



Min. Load ↔
Load 100 %

t 10 mS/div
Vo 100 mV/div

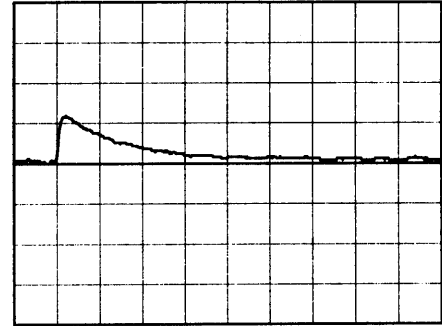
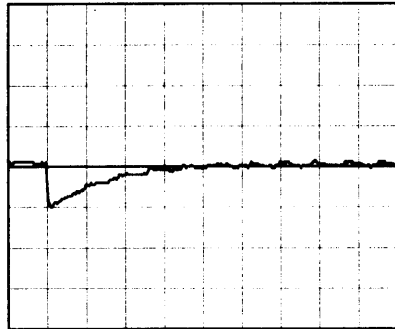

Min. Load ↔
Load 50 %

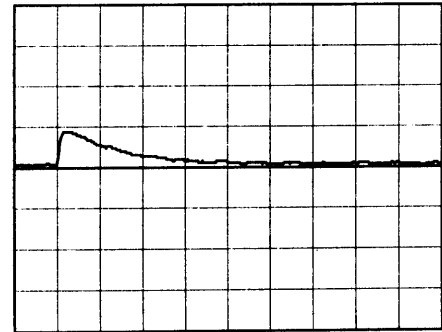
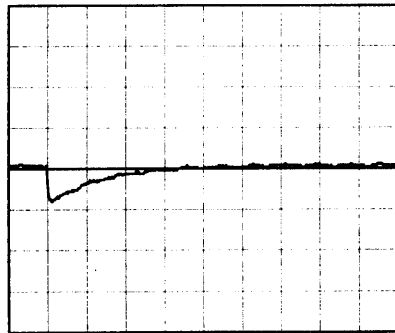



Model	PAA75F-12	Temperature	25°C
Item	Rise and Fall Time 立上り、立下り時間	Testing Circuitry	Figure A
Object	+12V6.3A		

1. Graph

Input Volt. 85 V

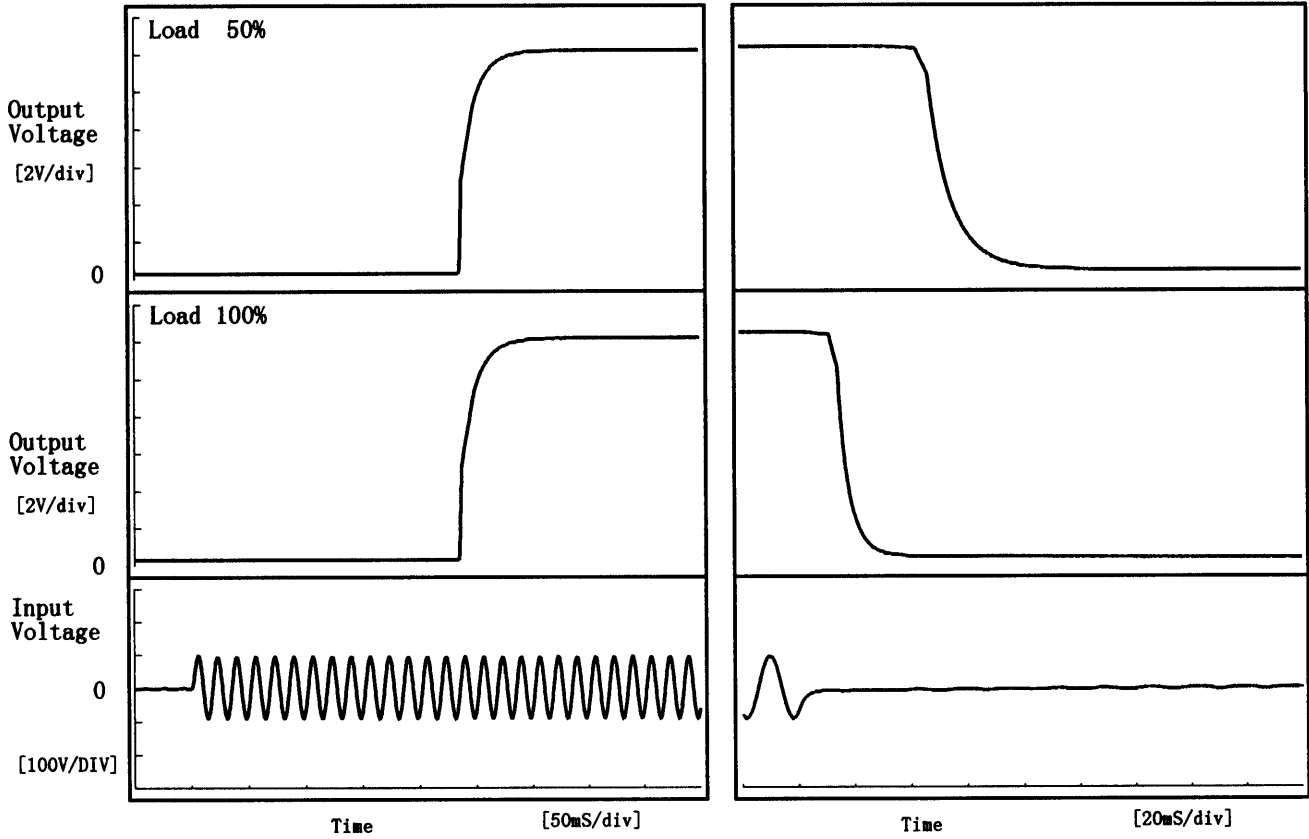

2. Values

[mS]

Load \ Time	T d	T r	T s	T h	T f
50 %	235.5	25.3	260.8	45.8	20.0
100 %	235.5	26.0	261.5	13.5	10.4

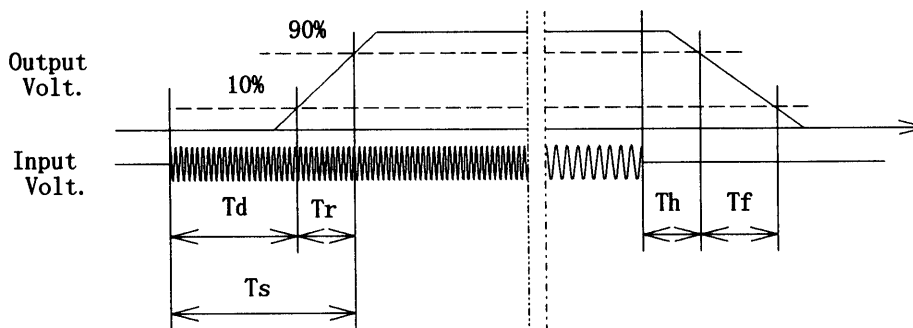

COSEL

Model	PAA75F-12
Item	Ambient Temperature Drift 周囲温度変動
Object	+12V6.3A

Testing Circuitry Figure A

1. Graph
- △— Input Volt. 85V
 - - -□- - - Input Volt. 100V
 - Input Volt. 132V

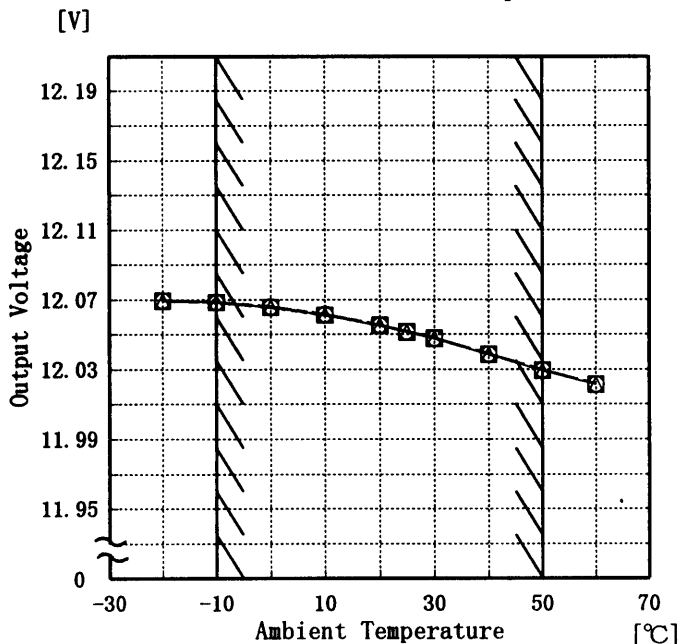

Load 100%

Note: Slanted line shows the range of the rated ambient temperature.

(注) 斜線は定格周囲温度範囲を示す。

2. Values

Temperature [°C]	Input Volt. 85[V]	Input Volt. 100[V]	Input Volt. 132[V]
	Output Volt. [V]	Output Volt. [V]	Output Volt. [V]
-20	12.069	12.069	12.070
-10	12.068	12.068	12.069
0	12.065	12.066	12.066
10	12.061	12.061	12.061
20	12.055	12.055	12.055
25	12.051	12.051	12.052
30	12.048	12.048	12.048
40	12.039	12.039	12.039
50	12.029	12.030	12.030
60	12.021	12.021	12.021
—	—	—	—



Model	PAA75F-12
Item	Minimum Input Voltage for Regulated Output Voltage 最低レギュレーション電圧
Object	+12V6.3A

Testing Circuitry Figure A

1. Graph

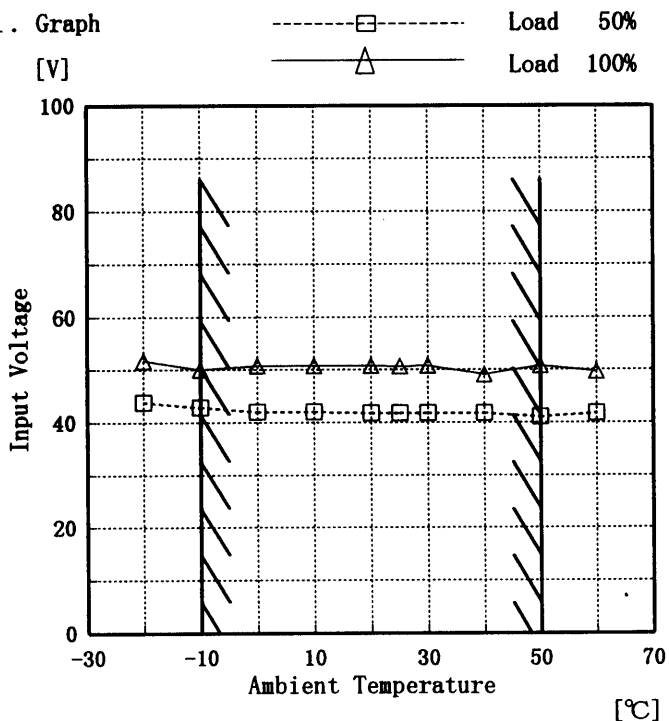

Note: Slanted line shows the range of the rated ambient temperature.

(注) 斜線は定格周囲温度範囲を示す。

2. Values

Ambient Temp. [°C]	Load 50% Input Volt. [V]	Load 100% Input Volt. [V]
-20	44	52
-10	43	50
0	42	51
10	42	51
20	42	51
25	42	51
30	42	51
40	42	49
50	41	51
60	42	50
—	—	—



Model	PAA75F-12
Item	Ripple Voltage (by Ambient Temp.) リップル電圧 (周囲温度特性)
Object	+12V6.3A

Testing Circuitry Figure A

1. Graph

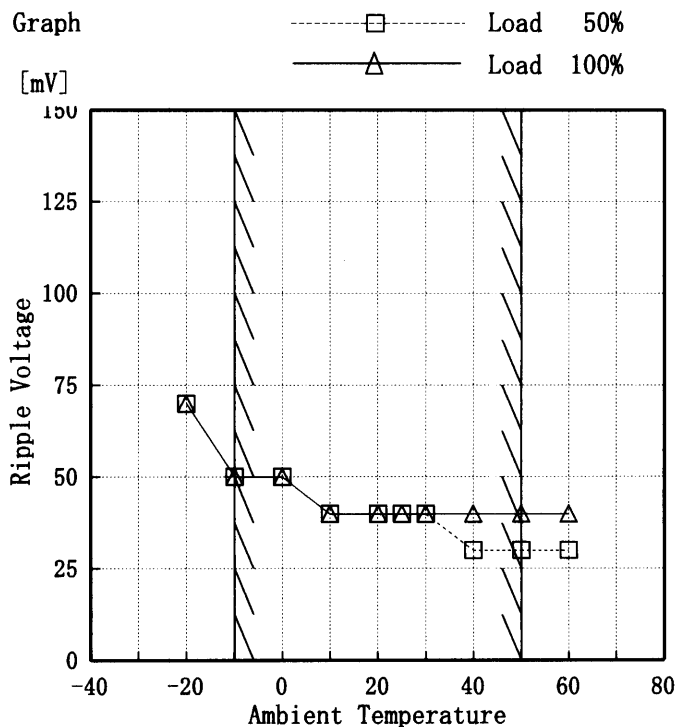

2. Values

Ambient Temp. [°C]	Load 50%	Load 100%
	Ripple Output Volt. [mV]	Ripple Output Volt. [mV]
-20	70	70
-10	50	50
0	50	50
10	40	40
20	40	40
25	40	40
30	40	40
40	30	40
50	30	40
60	30	40
—	—	—

Input Volt. 100 V

Note: Slanted line shows the range of the rated ambient temperature.

(注) 斜線は定格周囲温度範囲を示す。



Model PAA75F-12		Temperature 25 °C Testing Circuitry Figure A																						
Item	Time Lapse Drift 経時ドリフト																							
Object	+12V6.3A																							
<p>1. Graph</p> <p>[V]</p> <p>Output Voltage [V]</p> <p>Time [H]</p> <p>Input Volt. 100V Load 100%</p>		<p>2. Values</p> <table border="1"> <thead> <tr> <th>Time since start [H]</th> <th>Output Voltage [V]</th> </tr> </thead> <tbody> <tr><td>0.0</td><td>12.057</td></tr> <tr><td>0.5</td><td>12.052</td></tr> <tr><td>1.0</td><td>12.052</td></tr> <tr><td>2.0</td><td>12.052</td></tr> <tr><td>3.0</td><td>12.052</td></tr> <tr><td>4.0</td><td>12.052</td></tr> <tr><td>5.0</td><td>12.052</td></tr> <tr><td>6.0</td><td>12.052</td></tr> <tr><td>7.0</td><td>12.052</td></tr> <tr><td>8.0</td><td>12.052</td></tr> </tbody> </table>	Time since start [H]	Output Voltage [V]	0.0	12.057	0.5	12.052	1.0	12.052	2.0	12.052	3.0	12.052	4.0	12.052	5.0	12.052	6.0	12.052	7.0	12.052	8.0	12.052
Time since start [H]	Output Voltage [V]																							
0.0	12.057																							
0.5	12.052																							
1.0	12.052																							
2.0	12.052																							
3.0	12.052																							
4.0	12.052																							
5.0	12.052																							
6.0	12.052																							
7.0	12.052																							
8.0	12.052																							



Model		PAA75F-12	Testing Circuitry Figure A
Item		Output Voltage Accuracy 定電圧精度	
Object		+12V 6.3A	

Output Voltage Accuracy

This is defined as the value of the output voltage, regulation load, ambient temperature and input voltage varied at random in the range as specified below.

Temperature : -10~50 °C

Input Voltage : 85~132 V

Load Current : 0.0~6.3 A

* Output Voltage Accuracy = $\pm (\text{Maximum of Output Voltage} - \text{Minimum of Output Voltage}) / 2$

$$* \text{Output Voltage Accuracy (Ration)} = \frac{\text{Voltage Accuracy}}{\text{Rated Output Voltage}} \times 100$$

定電圧精度

周囲温度、入力電圧、負荷を下記仕様内で、任意に変動させたときの出力電圧の変動をいう。

周囲温度 -10~50 °C

入力電圧 85~132 V

負荷電流 0.0~6.3 A

* 定電圧精度(変動値) = $\pm (\text{出力電圧の最高値} - \text{出力電圧の最低値}) / 2$

$$* \text{定電圧精度(変動率)} = \frac{\text{変動値}}{\text{定格出力電圧}} \times 100$$

Item	Temperature [°C]	Input Voltage [V]	Output Current [A]	Output Voltage [V]	Output Voltage Accuracy [mV]	Output Voltage Accuracy (Ration) [%]
Maximum Voltage	-10	132	0.0	12.079	±26	±0.3
Minimum Voltage	50	132	6.3	12.027		



Model	PAA75F-12	Temperature	25°C
Item	Harmonic Current	Testing Circuitry	Figure E
Object	+12V6.3A		

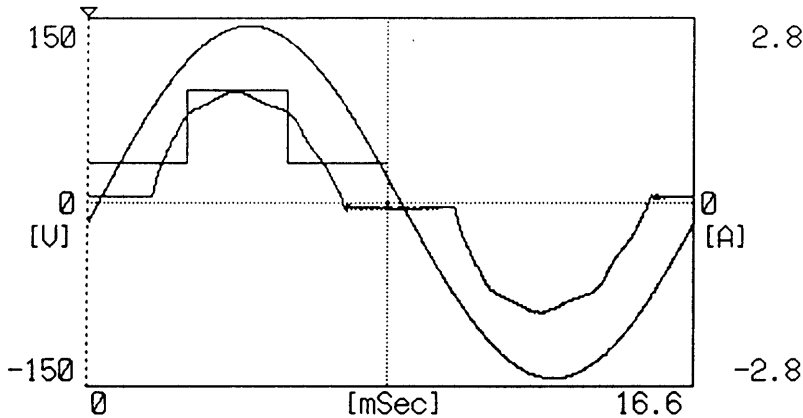

Conditions	Values
Input Voltage [V]	100
Input Current [A]	1.02
Active Power [W]	94.6
Apparent Power [VA]	101.4
Frequency [Hz]	60
Power Factor	0.933
Output Power [W]	75.6

2. Harmonic Current

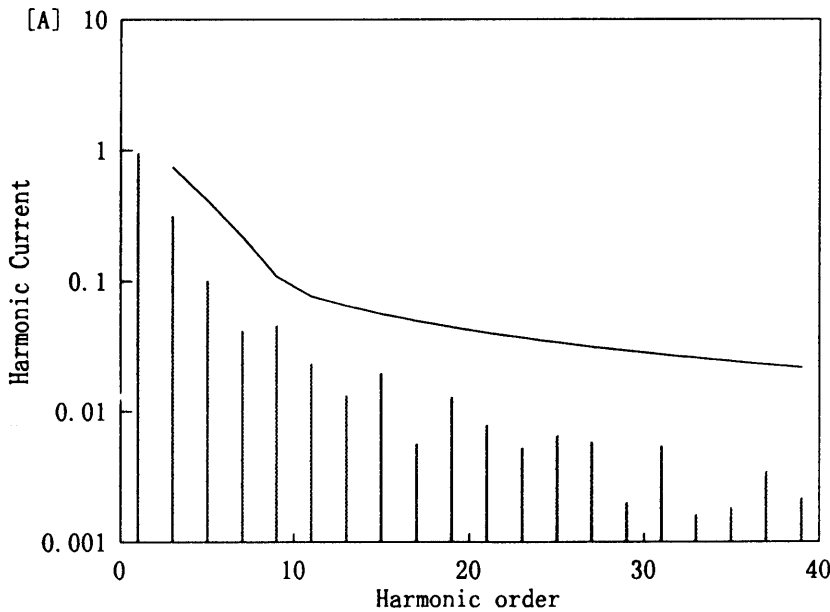

— Harmonic Current
 高調波電流
 - - - Limits for Class D equipment
 クラスDの機器に対する限度値

Harmonics order 高調波次数	Limits 限度値 [A]	Values 測定値 [A]
1	—	0.957
2	—	0.000
3	0.740	0.319
4	—	0.000
5	0.413	0.102
6	—	0.000
7	0.218	0.042
8	—	0.000
9	0.109	0.046
10	—	0.000
11	0.076	0.023
12	—	0.000
13	0.064	0.013
14	—	0.000
15	0.056	0.020
16	—	0.000
17	0.049	0.006
18	—	0.000
19	0.044	0.013
20	—	0.000
21	0.040	0.008
22	—	0.000
23	0.036	0.005
24	—	0.000
25	0.034	0.007
26	—	0.000
27	0.031	0.006
28	—	0.000
29	0.029	0.002
30	—	0.000
31	0.027	0.005
32	—	0.000
33	0.025	0.002
34	—	0.000
35	0.024	0.002
36	—	0.000
37	0.023	0.003
38	—	0.000
39	0.021	0.002
40	—	0.000

COSEL

Model	PAA75F-12	Temperature	25°C
Item	Harmonic Current 高調波電流	Testing Circuitry	Figure E
Object	+12V6.3A		

Conditions	Values
Input Voltage [V]	100
Input Current [A]	0.52
Active Power [W]	46
Apparent Power [VA]	51.9
Frequency [Hz]	60
Power Factor	0.886
Output Power [W]	37.8

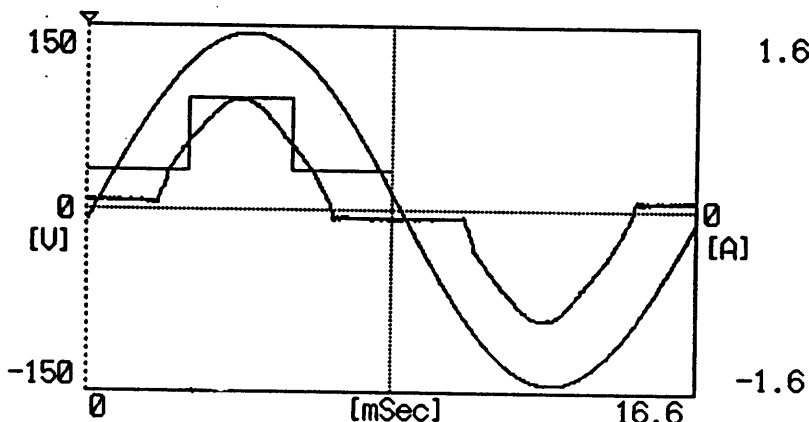

Harmonics order 高調波次数	Limits 限度値 [A]	Values 測定値 [A]
1	—	0.467
2	—	0.000
3	0.360	0.221
4	—	0.000
5	0.201	0.011
6	—	0.000
7	0.106	0.025
8	—	0.000
9	0.053	0.018
10	—	0.000
11	0.037	0.014
12	—	0.000
13	0.031	0.012
14	—	0.000
15	0.027	0.006
16	—	0.000
17	0.024	0.008
18	—	0.000
19	0.021	0.001
20	—	0.000
21	0.019	0.006
22	—	0.000
23	0.018	0.002
24	—	0.000
25	0.016	0.004
26	—	0.000
27	0.015	0.003
28	—	0.000
29	0.014	0.002
30	—	0.000
31	0.013	0.003
32	—	0.000
33	0.012	0.001
34	—	0.000
35	0.012	0.003
36	—	0.000
37	0.011	0.000
38	—	0.000
39	0.010	0.002
40	—	0.000

2. Harmonic Current

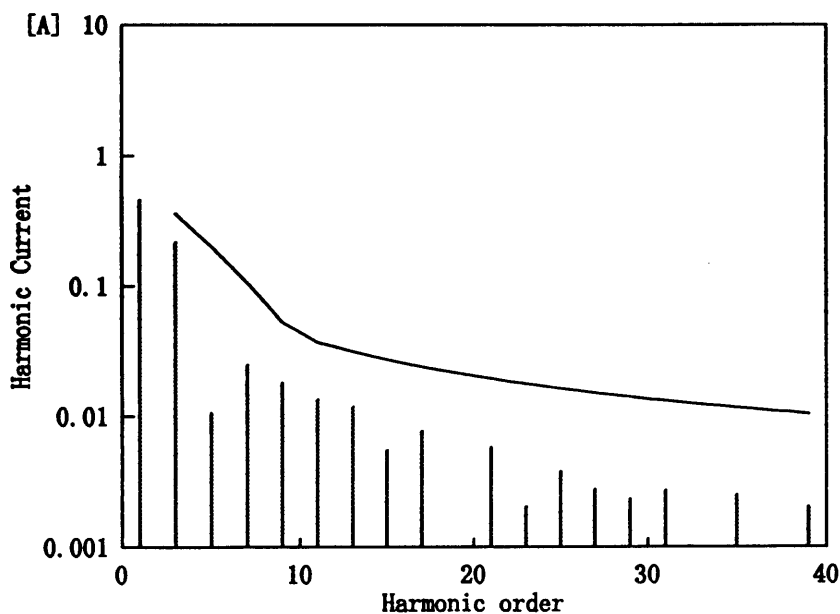

— Harmonic Current
 高調波電流
 — Limits for Class D equipment
 クラスDの機器に対する限度値



Model		PAA75F-12	Testing Circuitry Figure A
Item		Condensation 結露特性	
Object		+12V6.3A	

1. Condensation test

Testing procedure is as follows.

- ① Keeping and cooling the unit in a tank at -10°C for an hour with the input off.
- ② Taking it out of the tank and dewing itself in a room where the temperature is 25°C and the humidity is 40%RH.
- ③ Testing electrical characteristics (Output Voltage, Ripple Voltage, Ripple noise) of the unit to confirm there be no fault.
- ④ Repeating ①, ② and ③ three times.

1. 結露特性試験

入力を切った状態で、恒温槽で-10°Cに冷却しておき、約1時間後に恒温槽から取り出し、室温25°C、湿度40%RHの状態におき結露させ、その電気的特性（出力電圧、リップル、リップルノイズ）の測定を3度行い、異常のないことを確認する。

2. Values

	Times	Output Voltage [V]	Ripple Voltage [mV]	Ripple Noise [mV]
Load 50 %	1	12.187	40	50
	2	12.186	40	50
	3	12.187	40	50
Load 100 %	1	12.182	40	50
	2	12.182	40	50
	3	12.181	40	50

Input Volt. 100 V



Model		PAA75F-12	Testing Circuitry	Figure A
Item		Leakage Current 漏洩電流		
Object		+12V6.3A		

1. Results

Standards	Leakage Current [mA]		
	Input Volt. 85 [V]	Input Volt. 100 [V]	Input Volt. 132[V]
(A) DENTORI	0.13	0.16	0.19
(B) UL	0.11	0.14	0.18
(C) CSA	0.11	0.14	0.18

Standards	Leakage Current [mA]		
	Input Volt. 170 [V]	Input Volt. 220 [V]	Input Volt. 264 [V]
(D) VDE	-	-	-

2. Condition

Leakage current value is concluded after measuring both phases of AC input and by choosing the larger one.

交流入力 of 両相について測定し、その大きい方を漏洩電流測定値とする。

Load 100 %

- (A) Input Resistance : 1K Ω
- (B) Input Resistance : 1.5K Ω
Input Capacitance : 0.15 μ F
- (C) Input Resistance : 1.5K Ω
Input Capacitance : 0.15 μ F
- (D) Input Resistance : 2K Ω
Input Capacitance : 0.1 μ F



COSEL		Testing Circuitry Figure C
Model	PAA75F-12	
Item	Line Noise Tolerance 入力雑音耐量	
Object	+12V6.3A	

1. Results

Pulse Width [n S]	MODE	Operating Point of Overvoltage Protection [V] 過電圧保護動作値	DC-like Regulation of Output Voltage 出力電圧の直流的変動
50	COMMON	15.90	no regulation
	NORMAL	15.90	no regulation
1000	COMMON	15.80	no regulation
	NORMAL	15.80	no regulation

Conditions

Input Voltage :100 V
 Pulse Voltage :2000 V
 Pulse Cycle :10 mS
 Pulse Input Duration:1 min. or more
 Load :100 %



Model	PAA75F-12
Item	Conducted Emission 雑音端子電圧
Object	+12V6.3A

Testing Circuitry Figure D

1. Graph

Remarks

Input Volt. 120 V
Load 100 %

Note: Slanted line shows the range of Tolerance.

(注)斜線は許容値を示す。

NO	Standards	Standards Complied	Frequency [MHz]	Tolerance [dB/μV]
1	FCC class A		0.45~1.6	60
			1.6~30	69.5
2	FCC class B	○	0.45~30	48
3	VCCI -1		0.15~0.5	79
			0.5~30	73
4	VCCI -2	○	0.15~0.5	66-56
			0.5~5	56
			5~30	60
5	CISPR22-A		0.01~0.15	91-69.5
			0.15~0.5	66
			0.5~30	60
6	CISPR22-B		0.01~0.05	110
			0.05~0.15	90-80
			0.15~0.5	66-56
			0.5~5	56
			5~30	60

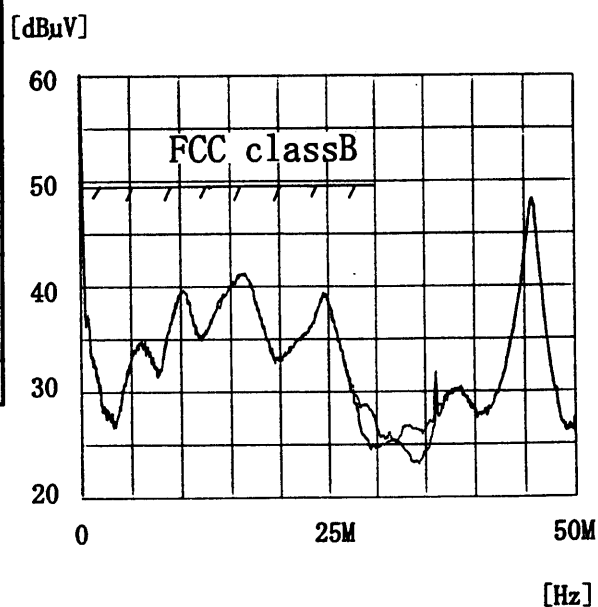
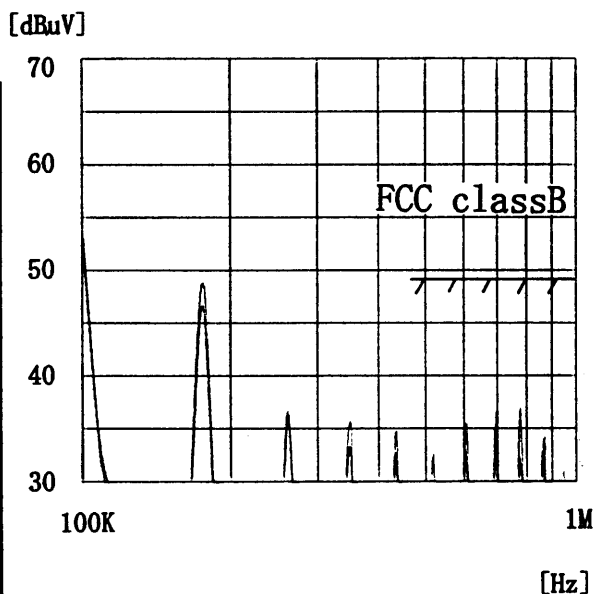

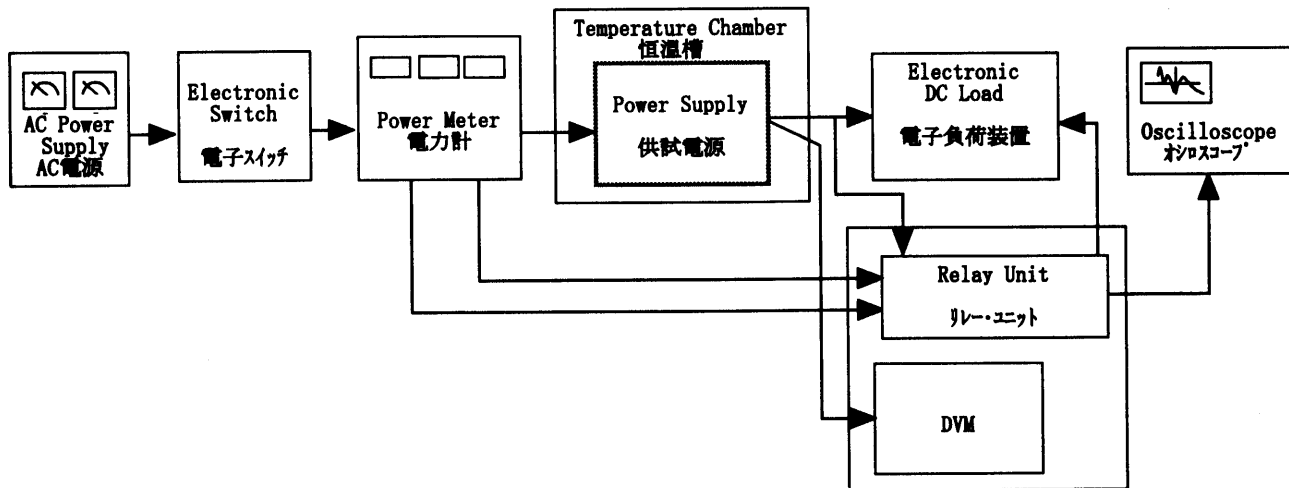

Figure A

Data Acquisition/Control Unit
データ収録システム

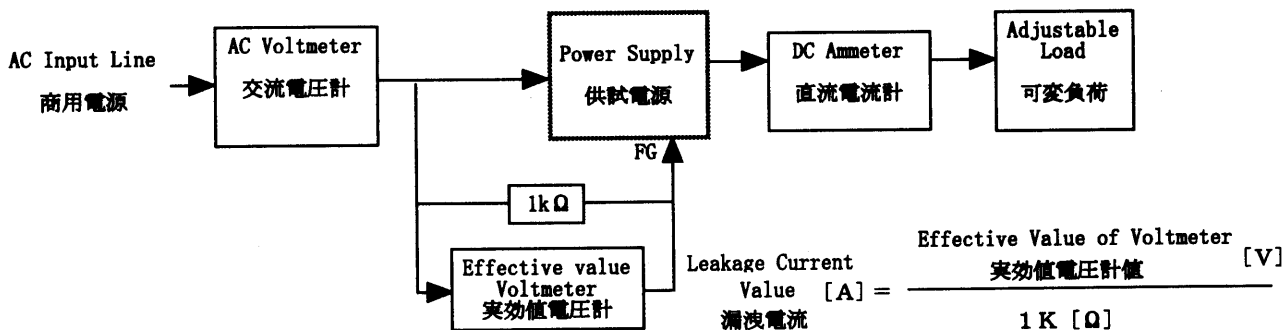

Figure B (DENTORI)

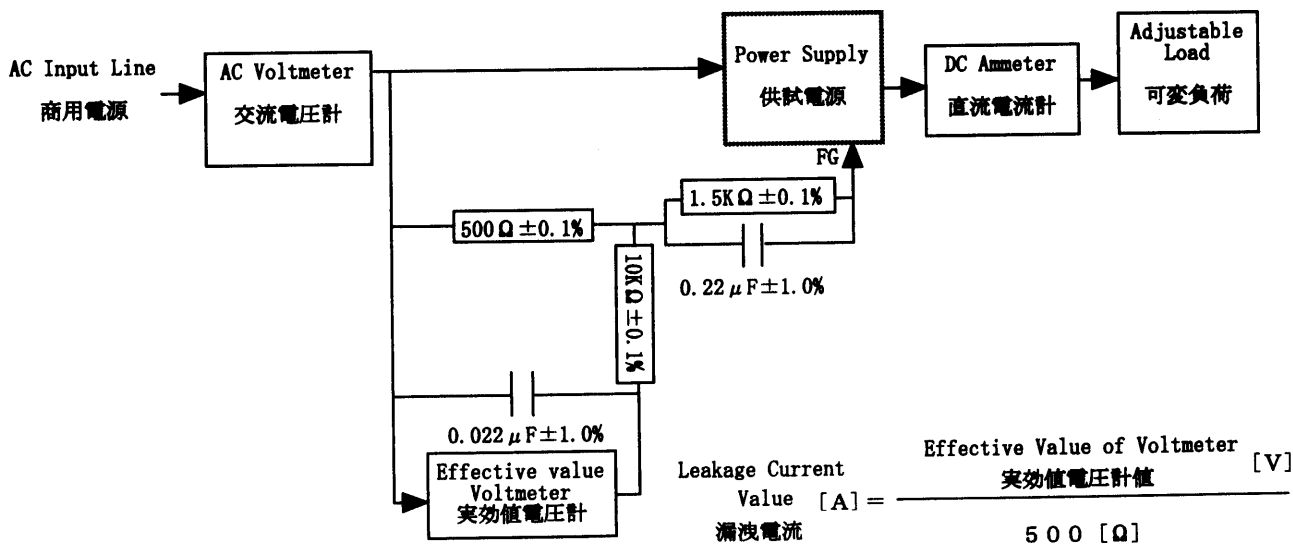

Figure B (UL, CSA, VDE)

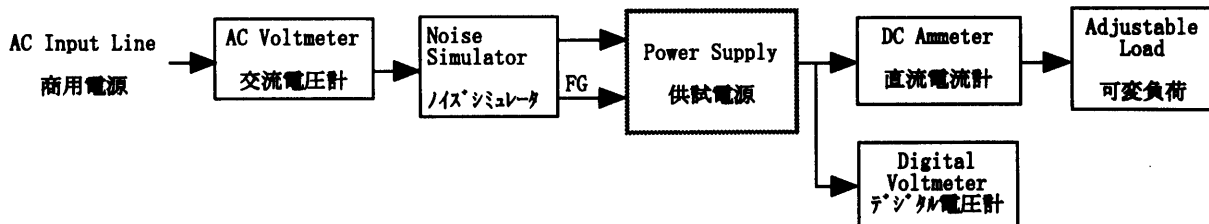

Figure C

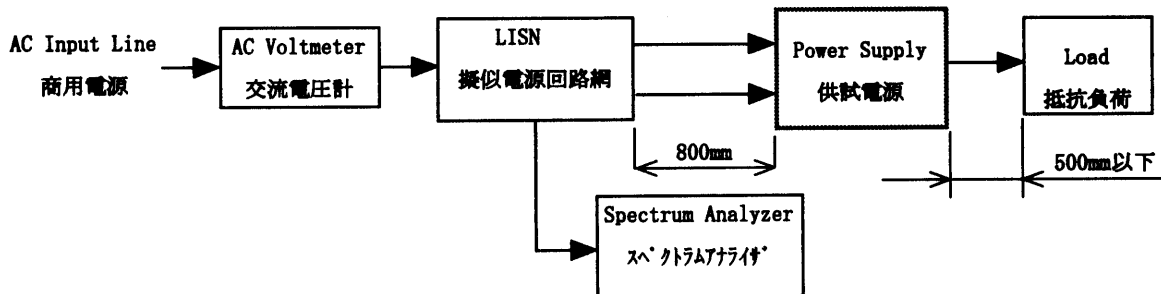

Figure D

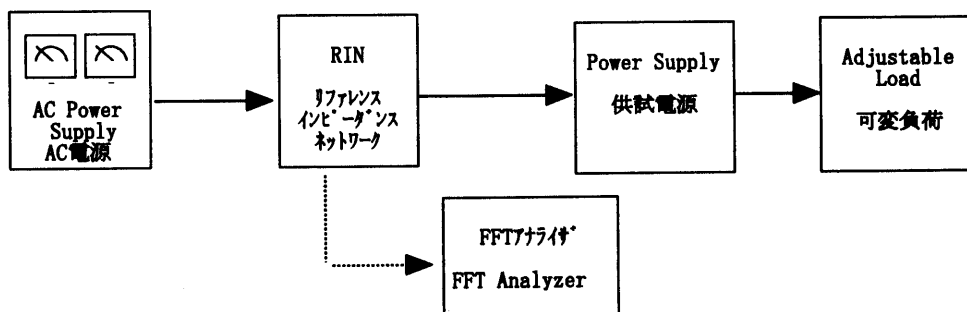

Figure E