

DATA SHEET		Date	03-Mar-16
Model	MGS34805	Temp.	25 degreeC
Test	EMI Line conduction & Radiated emission	Humid.	40 %RH
		Tested by	S.Mukaide

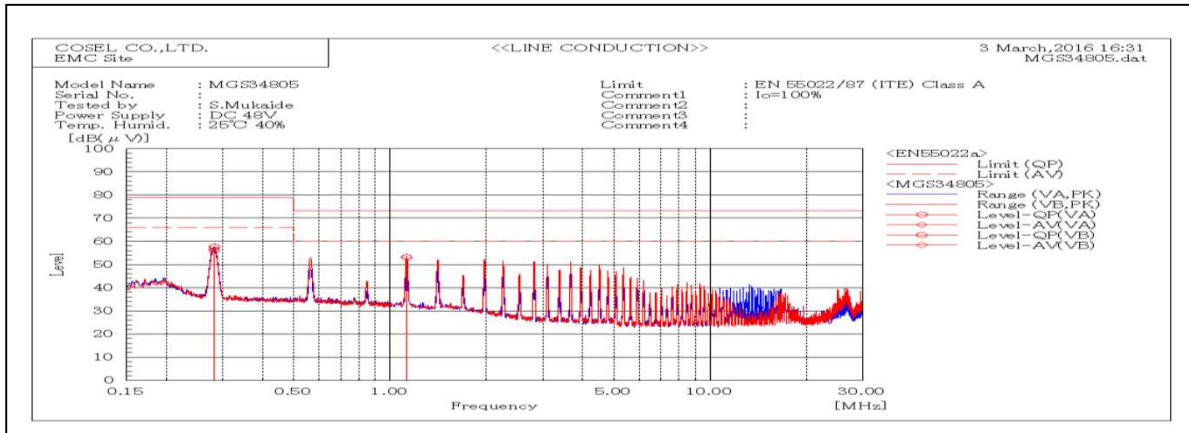

Frequency MHz	Harm	Line Phase	Reading dB(uV)		Factor dB	Level dB(uV)		Limit dB(uV)		Margin dB		Pass/Fail	Remark
			QP	AV		QP	AV	QP	AV	QP	AV		
0.28204		VB	36.2	36.4	20	56.2	56.4	79	66	22.8	9.6	Pass	
0.2825		VA	37.6	37.9	20	57.6	57.9	79	66	21.4	8.1	Pass	
1.12789		VB	33.2	33.3	20	53.2	53.3	73	60	19.8	6.7	Pass	

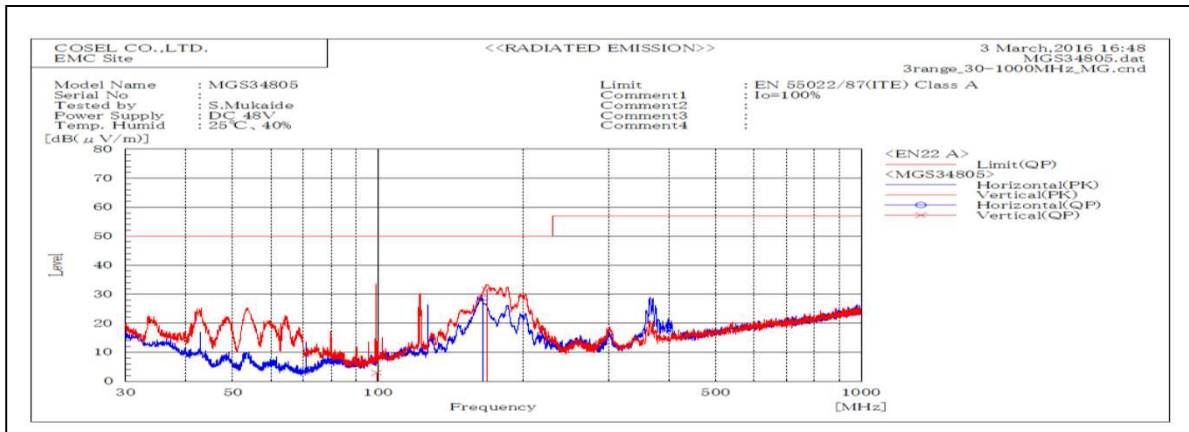

Frequency MHz	Harm	Polarization	Stability	Reading dB(uV)	Factor dB(1/m)	Level dB(uV/m)	Limit dB(uV/m)	Margin dB	Pass/Fail	Height cm	Angle deg	Remark
				QP		QP	QP					
99.338		V	Stable	24.5	-21.6	2.9	50	47.1	Pass	138	279	
164.31		H	Stable	49.9	-21.3	28.6	50	21.4	Pass	157	245	
167.864		V	Stable	47.9	-16.4	31.5	50	18.5	Pass	113	232	

DATA SHEET		Date	03-Mar-16
Model	Circuit used for measurement	Temp.	25 degreeC
Test	EMI Line conduction & Radiated emission	Humid.	40 %RH
		Tested by	S.Mukaide

1. Line conduction

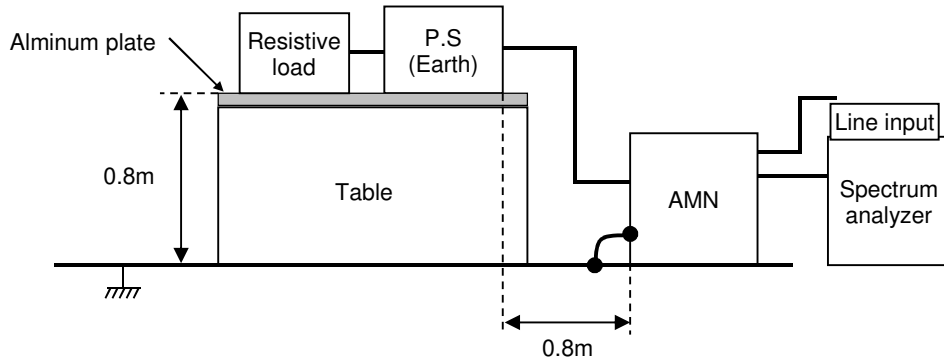

2. Radiated emission

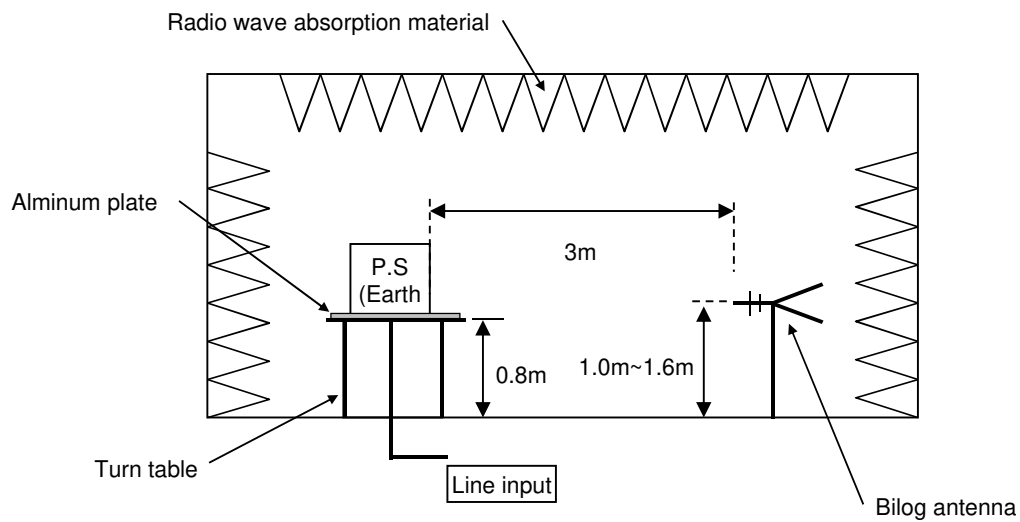

Conditions

Test : EMI
 Model Name : MGS3□□

○Photographs of Test Set-Up

LINE CONDUCTION

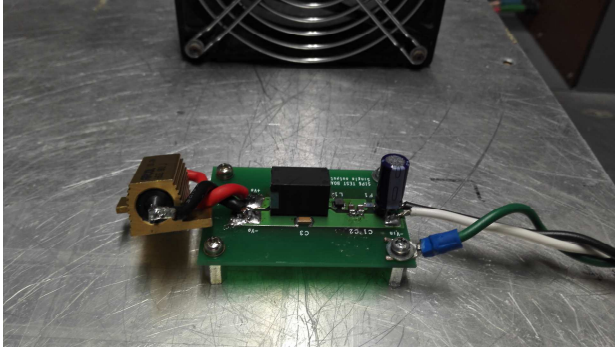

RADIATED EMISSION

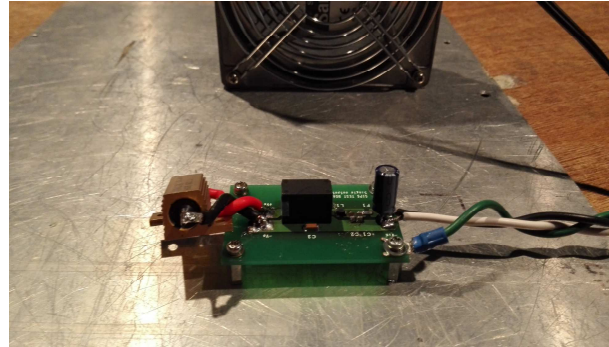

○Testing circuitry

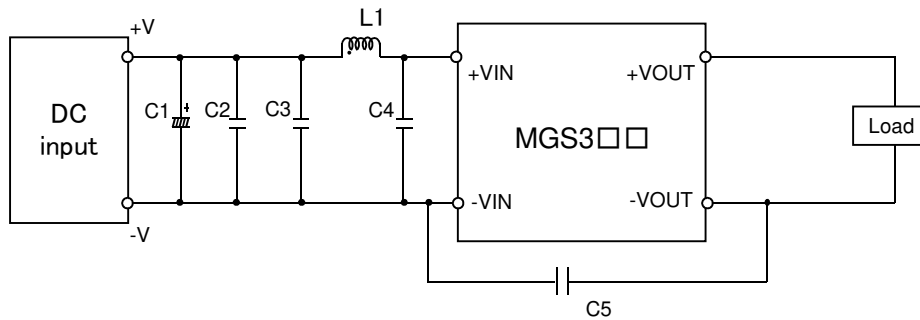

C1 : MGS305□□ 25V 100 μ F Electrolytic capacitor (LXZseries NIPPON CHEMI-CON)
 MGS312□□ -
 MGS324□□ -
 MGS348□□ -

C2,C3,C4 : MGS305□□ 16V 22 μ F Ceramic capacitor (GRM31CR71C226K MURATA MANUFACTURING)
 MGS312□□ 25V 10 μ F Ceramic capacitor (GRM31CR71E106K MURATA MANUFACTURING)
 MGS324□□ 50V 4.7 μ F Ceramic capacitor (GRM31CR71H475K MURATA MANUFACTURING)
 MGS348□□ 100V 2.2 μ F Ceramic capacitor (GRM31CR72A225K MURATA MANUFACTURING)

C5 : MGS305□□ 2kV 470pF Ceramic capacitor (GR442QR73D471K MURATA MANUFACTURING)
 MGS312□□ 2kV 470pF Ceramic capacitor (GR442QR73D471K MURATA MANUFACTURING)
 MGS324□□ 2kV 470pF Ceramic capacitor (GR442QR73D471K MURATA MANUFACTURING)
 MGS348□□ 2kV 470pF Ceramic capacitor (GR442QR73D471K MURATA MANUFACTURING)

L1 : MGS305□□ 1550mA 3.3 μ H Inductor(LQH32PN3R3NNCL MURATA MANUFACTURING)
 MGS312□□ 1200mA 4.7 μ H Inductor(LQH32PN4R7NNCL MURATA MANUFACTURING)
 MGS324□□ 900mA 10 μ H Inductor(LQH32PN100MNCL MURATA MANUFACTURING)
 MGS348□□ 550mA 22 μ H Inductor(LQH32PN220MNCL MURATA MANUFACTURING)