

DATA SHEET		Date	06-Jan-17
Model	MGFS64805	Temp.	25 degreeC
Test	EMI Line conduction & Radiated emission	Humid.	40 %RH
		Tested by	S.Mukaide

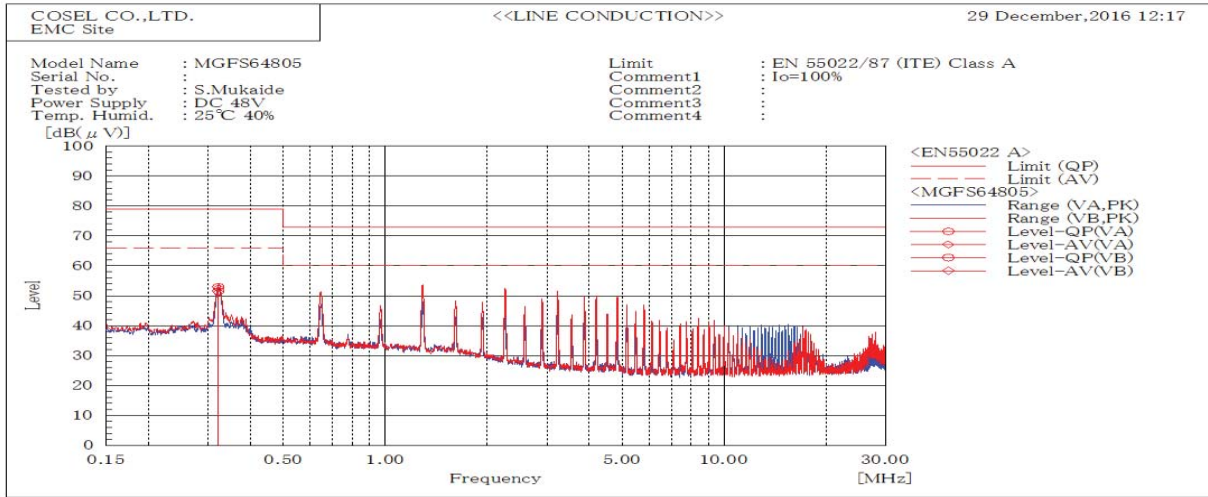

Frequency MHz	Line Phase	Level dB(uV)		Limit dB(uV)		Margin dB		Pass/Fail	Remark
		QP	AV	QP	AV	QP	AV		
0.32159	VB	52.9	52.6	79	66	26.1	13.4	Pass	
0.32172	VA	51.6	51.2	79	66	27.4	14.8	Pass	

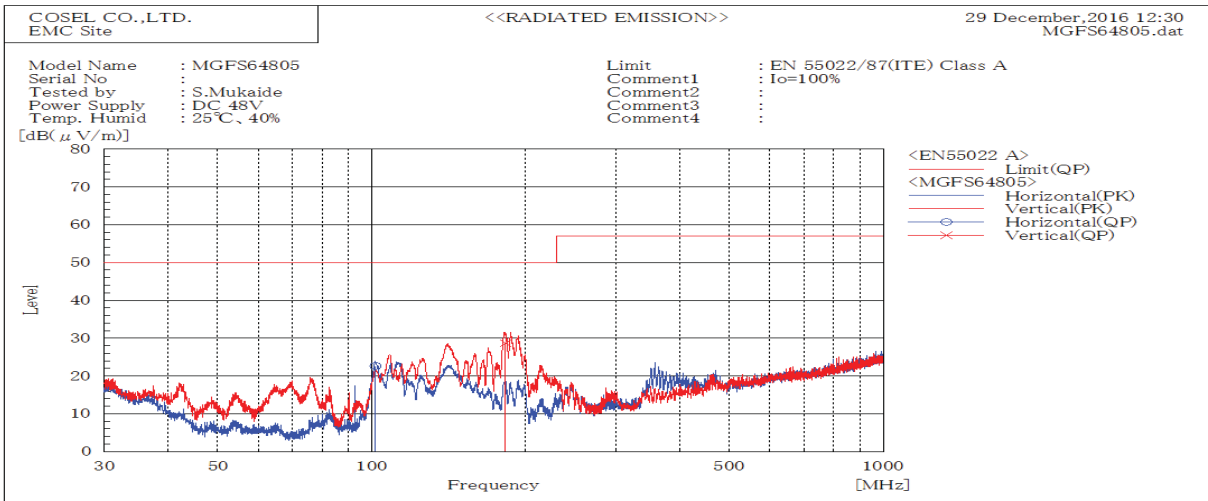

Frequency MHz	Polarization	Stability	Reading dB(uV)	Limit dB(uV/m)	Margin dB(uV/m)	Pass/Fail	Height cm	Angle deg	Remark
			QP	QP	QP				
101.671	H	Stable	22.7	50.0	27.3	Pass	148	262	
182.640	V	Stable	28.7	50.0	21.3	Pass	115	356	

DATA SHEET		Date	06-Jan-17
Model	Circuit used for measurement	Temp.	25 degreeC
Test	EMI Line conduction & Radiated emission	Humid.	40 %RH
		Tested by	S.Mukaide

1. Line conduction

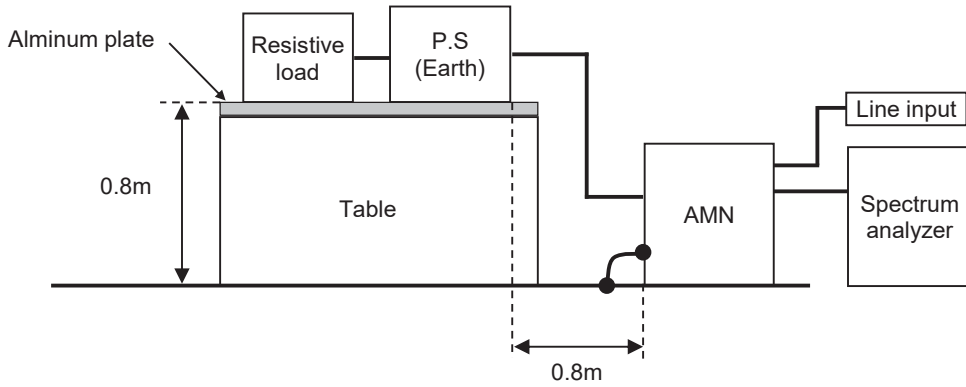

2. Radiated emission

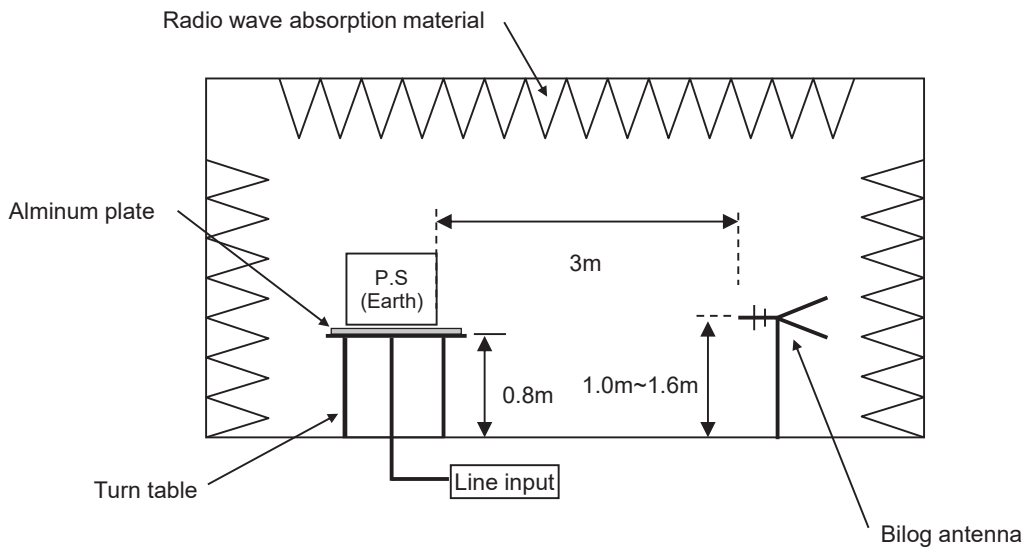

Conditions

Test : EMI
 Model Name : MGFS6□□

○Photographs of Test Set-Up

LINE CONDUCTION

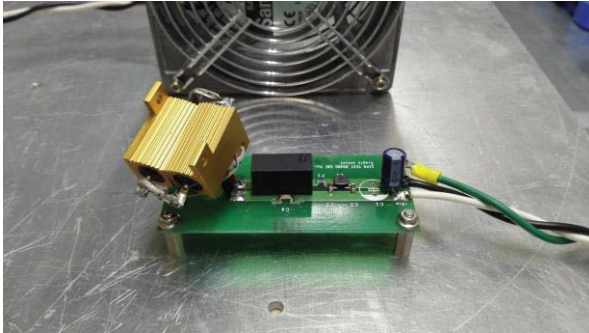

RADIATED EMISSION

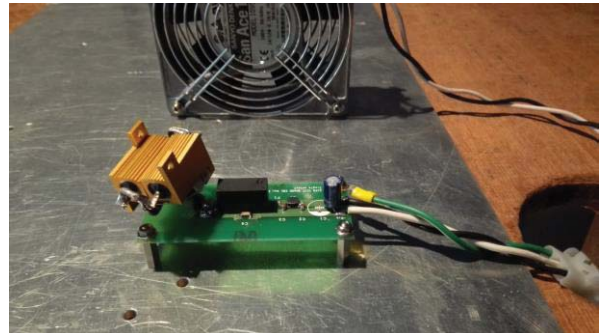

○Testing circuitry

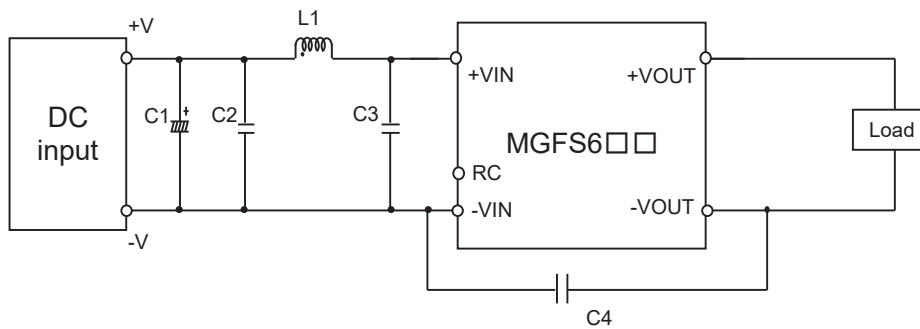

- C1 : MGFS624□□ 50V 100 μ F Electric capacitor (LXZseries NIPPON CHEMI-CON)
 MGFS648□□ -
- C2 : MGFS624□□ 50V 4.7 μ F Ceramic capacitor (GRM31CR71H475K MURATA MANUFACTURING)
 MGFS648□□ 100V 2.2 μ F Ceramic capacitor (GRM31CC72A225K MURATA MANUFACTURING)
- C3 : MGFS624□□ 50V 4.7 μ F Ceramic capacitor (GRM31CR71H475K MURATA MANUFACTURING)
 MGFS648□□ 100V 2.2 μ F Ceramic capacitor (GRM31CC72A225K MURATA MANUFACTURING)
- C4 : MGFS624□□ 2kV 470pF Ceramic capacitor (GR442QR73D471K MURATA MANUFACTURING)
 MGFS648□□ 2kV 2200pF Ceramic capacitor (GR443QR73D222K MURATA MANUFACTURING)
- L1 : MGFS624□□ 1600mA 10 μ H Inductor(LQH5BPN100MT0 MURATA MANUFACTURING)
 MGFS648□□ 1050mA 22 μ H Inductor(LQH5BPN220MT0 MURATA MANUFACTURING)