

DATA SHEET		Date	06-Jan-17
Model	MGFS62412	Temp.	25 degreeC
Test	EMI Line conduction & Radiated emission	Humid.	40 %RH
		Tested by	S.Mukaide

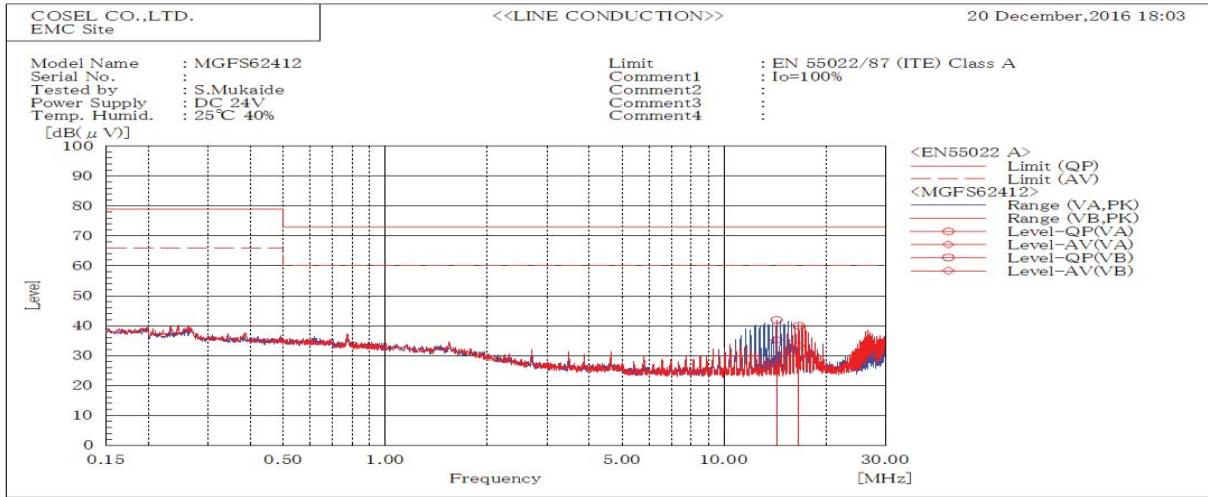

Frequency MHz	Line Phase	Level dB(uV)		Limit dB(uV)		Margin dB		Pass/Fail	Remark
		QP	AV	QP	AV	QP	AV		
14.3143	VA	41.9	35.2	73	60	31.1	24.8	Pass	
16.625	VB	40	33.3	73	60	33	26.7	Pass	

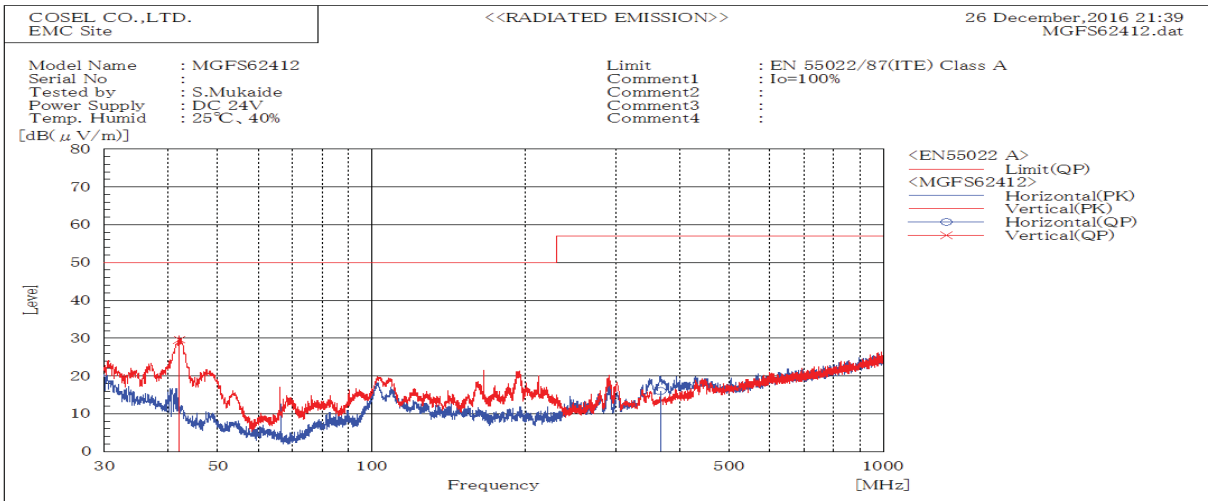

Frequency MHz	Polarization	Stability	Reading dB(uV)	Limit dB(uV/m)	Margin dB(uV/m)	Pass/Fail	Height cm	Angle deg	Remark
			QP	QP	QP				
42.091	V	Stable	29.6	50.0	20.4	Pass	105	352	
366.360	H	Stable	16.0	57.0	41.0	Pass	131	249	

DATA SHEET		Date	06-Jan-17
Model	Circuit used for measurement	Temp.	25 degreeC
Test	EMI	Humid.	40 %RH
	Line conduction & Radiated emission	Tested by	S.Mukaide

1. Line conduction

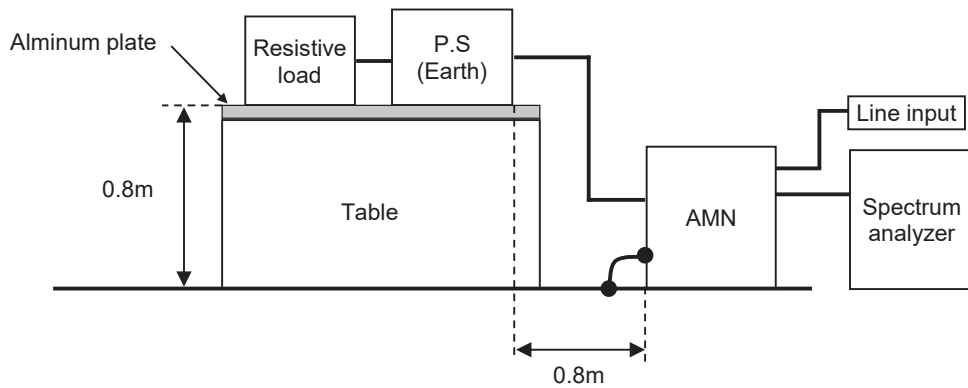

2. Radiated emission

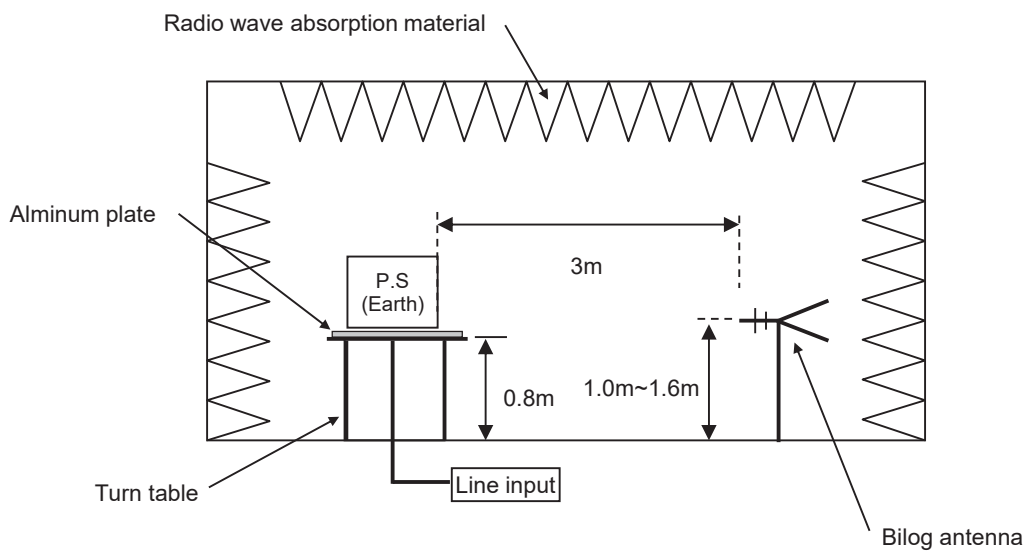

Conditions

Test : EMI
 Model Name : MGFS6□□

○Photographs of Test Set-Up

LINE CONDUCTION

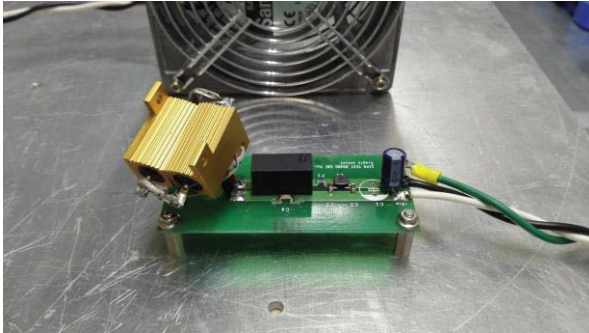

RADIATED EMISSION

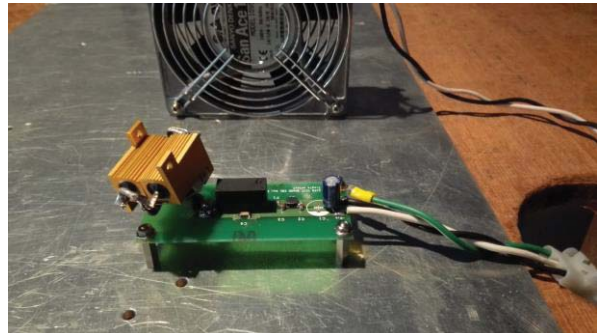

○Testing circuitry

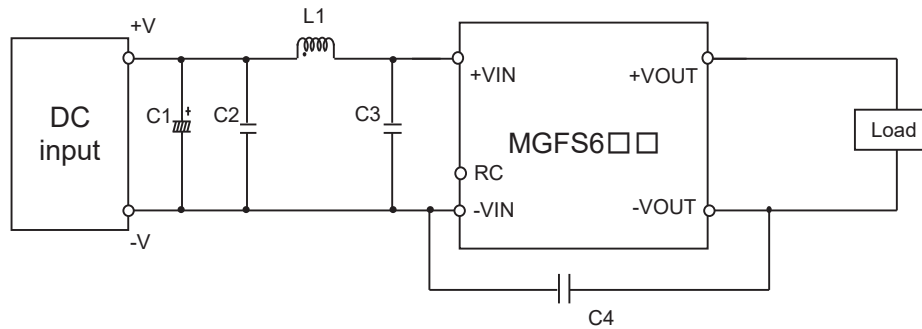

- C1 : MGFS624□□ 50V 100 μ F Electric capacitor (LXZseries NIPPON CHEMI-CON)
 MGFS648□□ -
- C2 : MGFS624□□ 50V 4.7 μ F Ceramic capacitor (GRM31CR71H475K MURATA MANUFACTURING)
 MGFS648□□ 100V 2.2 μ F Ceramic capacitor (GRM31CC72A225K MURATA MANUFACTURING)
- C3 : MGFS624□□ 50V 4.7 μ F Ceramic capacitor (GRM31CR71H475K MURATA MANUFACTURING)
 MGFS648□□ 100V 2.2 μ F Ceramic capacitor (GRM31CC72A225K MURATA MANUFACTURING)
- C4 : MGFS624□□ 2kV 470pF Ceramic capacitor (GR442QR73D471K MURATA MANUFACTURING)
 MGFS648□□ 2kV 2200pF Ceramic capacitor (GR443QR73D222K MURATA MANUFACTURING)
- L1 : MGFS624□□ 1600mA 10 μ H Inductor(LQH5BPN100MT0 MURATA MANUFACTURING)
 MGFS648□□ 1050mA 22 μ H Inductor(LQH5BPN220MT0 MURATA MANUFACTURING)