

DATA SHEET		Date	15-Jan-19
Model	MGFS402405	Temp.	25 degreeC
Test	EMI Line conduction & Radiated emission	Humid.	40 %RH
		Tested by	H.Yamaoka

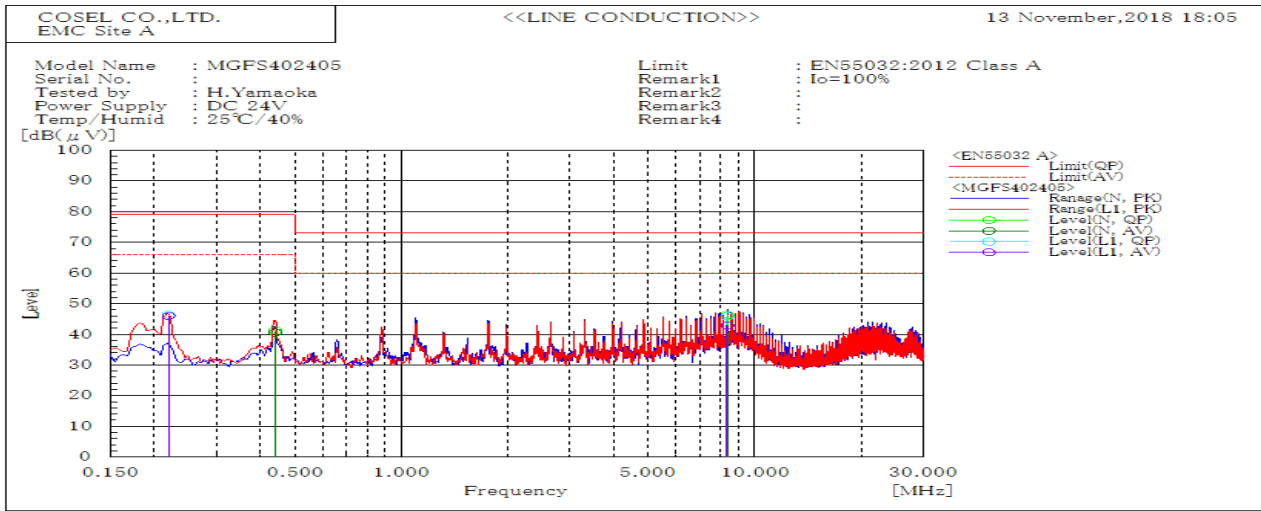

Frequency MHz	Line	Level dB(μV)		Limit dB(μV)		Margin dB		Pass/Fail	Remark
		QP	AV	QP	AV	QP	AV		
8.364	N	46.3	43	73	60	26.7	17	Pass	
0.441	N	41.3	40.6	79	66	37.7	25.4	Pass	
8.353	L1	45.8	42.9	73	60	27.2	17.1	Pass	
0.219	L1	46.4	46	79	66	32.6	20	Pass	

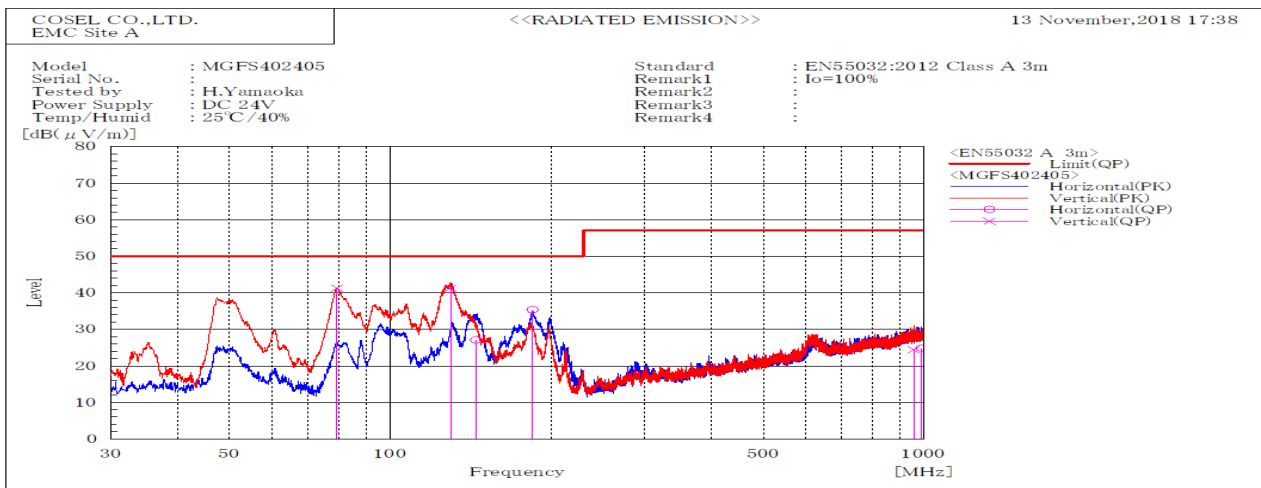

Frequency MHz	Polarization	Stability	Level dB(μV/m)		Limit dB(μV/m)	Margin dB	Pass/Fail	Height cm	Angle deg	Remark
			QP	QP						
129.769	V	Stable	41.3	50	8.7	Pass	101.4	271		
79.431	V	Stable	41.3	50	8.7	Pass	100	343.7		
956.658	V	Stable	24.4	57	32.6	Pass	234.1	350.4		
184.763	H	Stable	35.4	50	14.6	Pass	133.3	192.3		
989.274	H	Stable	24.9	57	32.1	Pass	128.4	276		
144.769	H	Stable	27.1	50	22.9	Pass	214	0		

DATA SHEET		Date	15-Jan-19
Model	Circuit used for measurement	Temp.	25 degreeC
Test	EMI Line conduction & Radiated emission	Humid.	40 %RH
		Tested by	H.Yamaoka

1. Line conduction

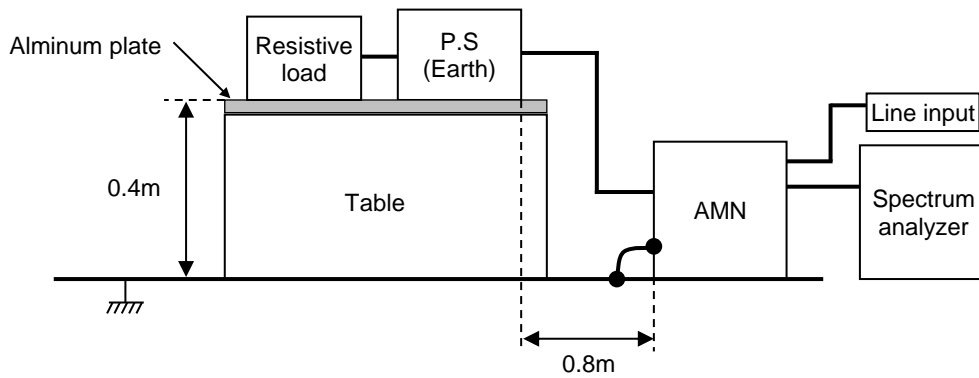

2. Radiated emission

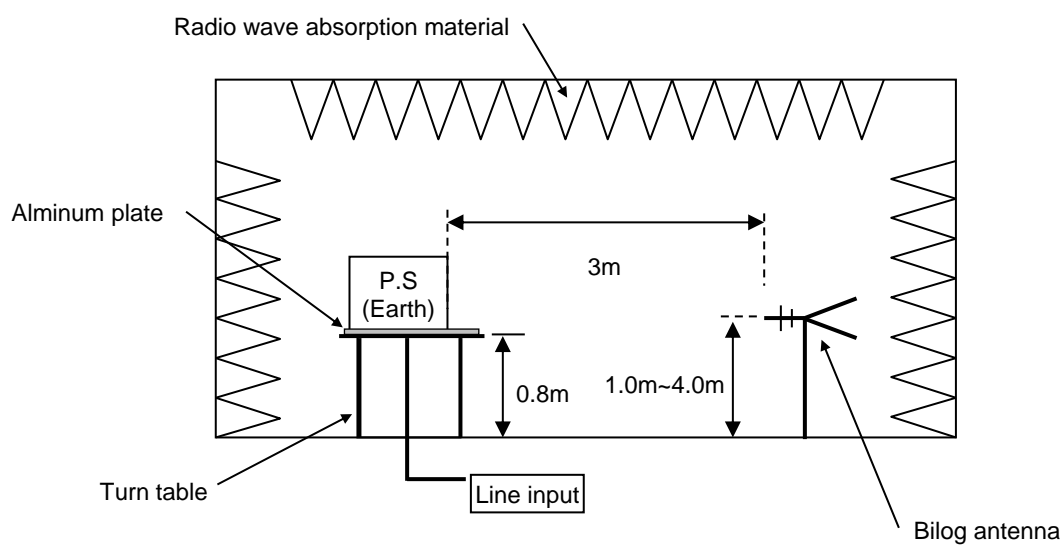

Conditions

Test : EMI
 Model Name: MGFS40□□

○Photographs of Test Set-Up
LINE CONDUCTION

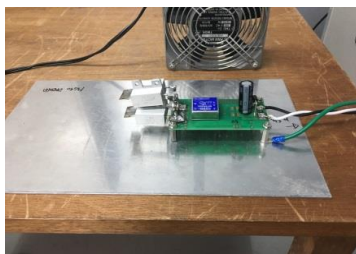

RADIATED EMISSION

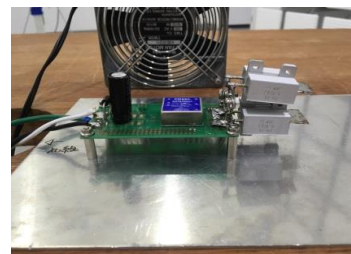

○Testing circuitry

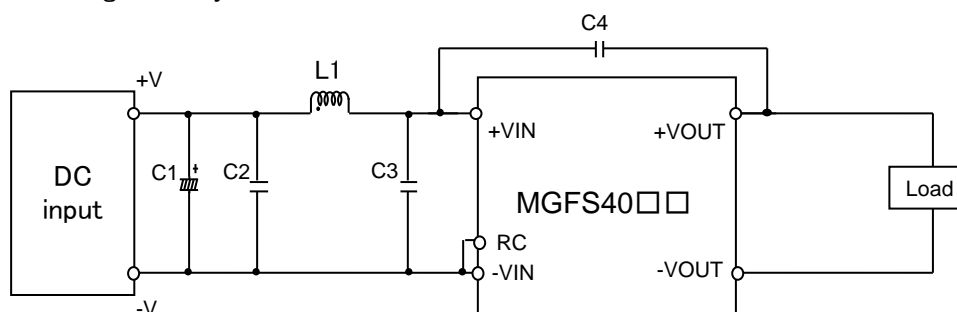

Fig.1 Testing circuitry

- | | | |
|------|------------|---------------------------------------------------------------------|
| C1 : | MGFS4005□□ | 10V 4700μ F Electrolytic capacitor (UHWseries NICHICON CORPORATION) |
| | MGFS4024□□ | 63V 220μ F Electrolytic capacitor (KYseries NIPPON CHEMI-CON) |
| | MGFS4048□□ | 100V 220μ F Electrolytic capacitor (KYseries NIPPON CHEMI-CON) |
| C2 : | MGFS4005□□ | 16V 22μ F Ceramic capacitor (GRM32ER71C226K MURATA MANUFACTURING) |
| | MGFS4024□□ | 50V 10μ F Ceramic capacitor (GRM32ER71H106K MURATA MANUFACTURING) |
| | MGFS4048□□ | 100V 4.7μ F Ceramic capacitor (HMK325AC7475K TAIYOU YUDEN) |
| C3 : | MGFS4005□□ | 16V 22μ F Ceramic capacitor (GRM32ER71C226K MURATA MANUFACTURING) |
| | MGFS4024□□ | 50V 10μ F Ceramic capacitor (GRM32ER71H106K MURATA MANUFACTURING) |
| | MGFS4048□□ | 100V 4.7μ F Ceramic capacitor (HMK325AC7475K TAIYOU YUDEN) |
| C4 : | MGFS4005□□ | 2kV 1000pF Ceramic capacitor (GR431BR7LA102K MURATA MANUFACTURING) |
| | MGFS4024□□ | 2kV 1000pF Ceramic capacitor (GR431BR7LA102K MURATA MANUFACTURING) |
| | MGFS4048□□ | 2kV 1000pF Ceramic capacitor (GR431BR7LA102K MURATA MANUFACTURING) |
| L1 : | MGFS4005□□ | 15.0A 1.0μ H Inductor (SRP7050TA-1R0M BOURNS) |
| | MGFS4024□□ | 12.0A 1.8μ H Inductor (SRP7050TA-1R8M BOURNS) |
| | MGFS4048□□ | 6.0A 5.6μ H Inductor (SRP7050TA-5R6M BOURNS) |