



TEST DATA OF LDA75F-12

(100V INPUT)

Regulated DC Power Supply

Date : Aug. 20. 1999

Approved by : *H. Yamaguchi*
Design Manager

Prepared by : *J. Asano*
Design Engineer

コーセル株式会社

COSEL CO.,LTD.

CONTENTS

1. Line Regulation	1
静的入力変動	
2. Input Current (by Load Current)	2
入力電流 (負荷特性)	
3. Input Power (by Load Current)	3
入力電力 (負荷特性)	
4. Efficiency (by Input Voltage)	4
効率 (入力電圧特性)	
5. Efficiency (by Load Current)	5
効率 (負荷特性)	
6. Hold-Up Time	6
出力保持時間	
7. Instantaneous Interruption Compensation	7
瞬時停電保障	
8. Load Regulation	8
静的負荷変動	
9. Ripple Voltage (by Load Current)	9
リップル電圧 (負荷特性)	
10. Ripple-Noise	10
リップルノイズ	
11. Overcurrent Protection	11
過電流保護	
12. Overvoltage Protection	12
過電圧保護	
13. Inrush Current	13
突入電流	
14. Dynamic Load Responce	14
動的負荷変動	
15. Rise and Fall Time	15
立上り、立下がり時間	
16. Ambient Temperature Drift	16
周囲温度変動	
17. Minimum Input Voltage for Regulated Output Voltage .	17
最低レギュレーション電圧	
18. Ripple Voltage (by Ambient Temperature)	18
リップル電圧 (周囲温度特性)	
19. Time Lapse Drift	19
経時ドリフト	
20. Output Voltage Accuracy	20
定電圧精度	
21. Condensation	21
結露特性	
22. Leakage Current	22
漏洩電流	
23. Line Noise Tolerance	23
入力雑音耐量	
24. Conducted Emission	24
雑音端子電圧	
25. Figure of Testing Circuitry	25
測定回路図	

(Final Page 26)



Model		LDA75F-12	Temperature 25°C Testing Circuitry Figure A																																
Item		Line Regulation 静的入力変動																																	
Object		+12.0V6.3A																																	
1. Graph		<div style="display: flex; justify-content: space-around;"> □ Load 50% △ Load 100% </div>	2. Values																																
			<table border="1"> <thead> <tr> <th rowspan="2">Input Voltage [V]</th> <th colspan="2">Output Voltage [V]</th> </tr> <tr> <th>Load 50%</th> <th>Load 100%</th> </tr> </thead> <tbody> <tr><td>75</td><td>12.105</td><td>12.100</td></tr> <tr><td>80</td><td>12.104</td><td>12.100</td></tr> <tr><td>85</td><td>12.104</td><td>12.100</td></tr> <tr><td>90</td><td>12.104</td><td>12.100</td></tr> <tr><td>100</td><td>12.104</td><td>12.100</td></tr> <tr><td>110</td><td>12.104</td><td>12.100</td></tr> <tr><td>120</td><td>12.104</td><td>12.100</td></tr> <tr><td>132</td><td>12.104</td><td>12.100</td></tr> <tr><td>140</td><td>12.104</td><td>12.100</td></tr> </tbody> </table>	Input Voltage [V]	Output Voltage [V]		Load 50%	Load 100%	75	12.105	12.100	80	12.104	12.100	85	12.104	12.100	90	12.104	12.100	100	12.104	12.100	110	12.104	12.100	120	12.104	12.100	132	12.104	12.100	140	12.104	12.100
Input Voltage [V]	Output Voltage [V]																																		
	Load 50%	Load 100%																																	
75	12.105	12.100																																	
80	12.104	12.100																																	
85	12.104	12.100																																	
90	12.104	12.100																																	
100	12.104	12.100																																	
110	12.104	12.100																																	
120	12.104	12.100																																	
132	12.104	12.100																																	
140	12.104	12.100																																	
Note: Slanted line shows the range of the rated input voltage.																																			
(注)斜線は定格入力電圧範囲を示す。																																			



Model LDA75F-12		Temperature 25°C																																																							
Item Input Current (by Load Current) 入力電流 (負荷特性)		Testing Circuitry Figure A																																																							
Output _____																																																									
<p>1. Graph</p> <p> Input Volt. 85V Input Volt. 100V Input Volt. 132V </p>		<p>2. Values</p> <table border="1"> <thead> <tr> <th rowspan="2">Load Current [A]</th> <th colspan="3">Input Current [A]</th> </tr> <tr> <th>Input Volt. 85[V]</th> <th>Input Volt. 100[V]</th> <th>Input Volt. 132[V]</th> </tr> </thead> <tbody> <tr><td>0.00</td><td>0.070</td><td>0.070</td><td>0.071</td></tr> <tr><td>1.00</td><td>0.356</td><td>0.323</td><td>0.274</td></tr> <tr><td>2.00</td><td>0.621</td><td>0.551</td><td>0.453</td></tr> <tr><td>3.00</td><td>0.909</td><td>0.800</td><td>0.649</td></tr> <tr><td>4.00</td><td>1.199</td><td>1.054</td><td>0.851</td></tr> <tr><td>5.00</td><td>1.486</td><td>1.304</td><td>1.052</td></tr> <tr><td>6.00</td><td>1.772</td><td>1.555</td><td>1.254</td></tr> <tr><td>6.30</td><td>1.862</td><td>1.634</td><td>1.319</td></tr> <tr><td>6.93</td><td>2.039</td><td>1.788</td><td>1.444</td></tr> <tr><td>—</td><td>—</td><td>—</td><td>—</td></tr> <tr><td>—</td><td>—</td><td>—</td><td>—</td></tr> <tr><td>—</td><td>—</td><td>—</td><td>—</td></tr> </tbody> </table>	Load Current [A]	Input Current [A]			Input Volt. 85[V]	Input Volt. 100[V]	Input Volt. 132[V]	0.00	0.070	0.070	0.071	1.00	0.356	0.323	0.274	2.00	0.621	0.551	0.453	3.00	0.909	0.800	0.649	4.00	1.199	1.054	0.851	5.00	1.486	1.304	1.052	6.00	1.772	1.555	1.254	6.30	1.862	1.634	1.319	6.93	2.039	1.788	1.444	—	—	—	—	—	—	—	—	—	—	—	—
Load Current [A]	Input Current [A]																																																								
	Input Volt. 85[V]	Input Volt. 100[V]	Input Volt. 132[V]																																																						
0.00	0.070	0.070	0.071																																																						
1.00	0.356	0.323	0.274																																																						
2.00	0.621	0.551	0.453																																																						
3.00	0.909	0.800	0.649																																																						
4.00	1.199	1.054	0.851																																																						
5.00	1.486	1.304	1.052																																																						
6.00	1.772	1.555	1.254																																																						
6.30	1.862	1.634	1.319																																																						
6.93	2.039	1.788	1.444																																																						
—	—	—	—																																																						
—	—	—	—																																																						
—	—	—	—																																																						
<p>Note: Slanted line shows the range of the rated load current</p> <p>(注)斜線は定格負荷電流範囲を示す。</p>																																																									



Model		LDA75F-12	Temperature		25°C																																																							
Item		Input Power (by Load Current) 入力電力 (負荷特性)	Testing Circuitry		Figure A																																																							
Output		_____																																																										
1. Graph			2. Values																																																									
<p> Input Volt. 85V Input Volt. 100V Input Volt. 132V </p>			<table border="1"> <thead> <tr> <th rowspan="2">Load Current [A]</th> <th colspan="3">Input Power [W]</th> </tr> <tr> <th>Input Volt. 85 [V]</th> <th>Input Volt. 100 [V]</th> <th>Input Volt. 132 [V]</th> </tr> </thead> <tbody> <tr><td>0.00</td><td>2.14</td><td>2.45</td><td>3.15</td></tr> <tr><td>1.00</td><td>16.48</td><td>16.74</td><td>17.55</td></tr> <tr><td>2.00</td><td>30.61</td><td>30.72</td><td>31.33</td></tr> <tr><td>3.00</td><td>45.10</td><td>45.06</td><td>45.50</td></tr> <tr><td>4.00</td><td>59.86</td><td>59.66</td><td>59.80</td></tr> <tr><td>5.00</td><td>74.72</td><td>74.33</td><td>74.20</td></tr> <tr><td>6.00</td><td>90.00</td><td>89.30</td><td>88.90</td></tr> <tr><td>6.30</td><td>94.70</td><td>93.90</td><td>93.40</td></tr> <tr><td>6.93</td><td>104.50</td><td>103.50</td><td>102.70</td></tr> <tr><td>—</td><td>—</td><td>—</td><td>—</td></tr> <tr><td>—</td><td>—</td><td>—</td><td>—</td></tr> <tr><td>—</td><td>—</td><td>—</td><td>—</td></tr> </tbody> </table>			Load Current [A]	Input Power [W]			Input Volt. 85 [V]	Input Volt. 100 [V]	Input Volt. 132 [V]	0.00	2.14	2.45	3.15	1.00	16.48	16.74	17.55	2.00	30.61	30.72	31.33	3.00	45.10	45.06	45.50	4.00	59.86	59.66	59.80	5.00	74.72	74.33	74.20	6.00	90.00	89.30	88.90	6.30	94.70	93.90	93.40	6.93	104.50	103.50	102.70	—	—	—	—	—	—	—	—	—	—	—	—
Load Current [A]	Input Power [W]																																																											
	Input Volt. 85 [V]	Input Volt. 100 [V]	Input Volt. 132 [V]																																																									
0.00	2.14	2.45	3.15																																																									
1.00	16.48	16.74	17.55																																																									
2.00	30.61	30.72	31.33																																																									
3.00	45.10	45.06	45.50																																																									
4.00	59.86	59.66	59.80																																																									
5.00	74.72	74.33	74.20																																																									
6.00	90.00	89.30	88.90																																																									
6.30	94.70	93.90	93.40																																																									
6.93	104.50	103.50	102.70																																																									
—	—	—	—																																																									
—	—	—	—																																																									
—	—	—	—																																																									
<p>Note: Slanted line shows the range of the rated load current</p> <p>(注)斜線は定格負荷電流範囲を示す。</p>																																																												



Model		LDA75F-12	Temperature	25°C																																
Item		Efficiency 効率	Testing Circuitry	Figure A																																
Object		_____																																		
1. Graph		□ Load 50%	2. Values																																	
<p>Efficiency [%]</p> <p>Input Voltage [V]</p>		<table border="1"> <thead> <tr> <th rowspan="2">Input Voltage [V]</th> <th colspan="2">Efficiency [%]</th> </tr> <tr> <th>Load 50%</th> <th>Load 100%</th> </tr> </thead> <tbody> <tr><td>75</td><td>81.3</td><td>79.9</td></tr> <tr><td>80</td><td>81.3</td><td>80.7</td></tr> <tr><td>85</td><td>81.3</td><td>81.1</td></tr> <tr><td>90</td><td>81.5</td><td>81.3</td></tr> <tr><td>100</td><td>81.5</td><td>81.7</td></tr> <tr><td>110</td><td>81.3</td><td>82.1</td></tr> <tr><td>120</td><td>81.1</td><td>82.1</td></tr> <tr><td>132</td><td>80.8</td><td>82.2</td></tr> <tr><td>140</td><td>80.5</td><td>82.2</td></tr> </tbody> </table>			Input Voltage [V]	Efficiency [%]		Load 50%	Load 100%	75	81.3	79.9	80	81.3	80.7	85	81.3	81.1	90	81.5	81.3	100	81.5	81.7	110	81.3	82.1	120	81.1	82.1	132	80.8	82.2	140	80.5	82.2
Input Voltage [V]	Efficiency [%]																																			
	Load 50%	Load 100%																																		
75	81.3	79.9																																		
80	81.3	80.7																																		
85	81.3	81.1																																		
90	81.5	81.3																																		
100	81.5	81.7																																		
110	81.3	82.1																																		
120	81.1	82.1																																		
132	80.8	82.2																																		
140	80.5	82.2																																		
<p>Note: Slanted line shows the range of the rated input voltage.</p> <p>(注)斜線は定格入力電圧範囲を示す。</p>																																				



Model		LDA75F-12	Temperature		25°C																																																							
Item		Efficiency (by Load Current) 効率 (負荷電流特性)	Testing Circuitry		Figure A																																																							
Output		_____																																																										
1. Graph			2. Values																																																									
<p> Input Volt. 85V Input Volt. 100V Input Volt. 132V </p>			<table border="1"> <thead> <tr> <th rowspan="2">Load Current [A]</th> <th colspan="3">Efficiency [%]</th> </tr> <tr> <th>Input Volt. 85[V]</th> <th>Input Volt. 100[V]</th> <th>Input Volt. 132[V]</th> </tr> </thead> <tbody> <tr><td>1.00</td><td>74.5</td><td>73.4</td><td>70.1</td></tr> <tr><td>2.00</td><td>79.4</td><td>79.2</td><td>77.6</td></tr> <tr><td>3.00</td><td>80.9</td><td>81.1</td><td>80.3</td></tr> <tr><td>4.00</td><td>81.4</td><td>81.7</td><td>81.5</td></tr> <tr><td>5.00</td><td>81.4</td><td>81.8</td><td>82.0</td></tr> <tr><td>6.00</td><td>81.1</td><td>81.7</td><td>82.1</td></tr> <tr><td>6.30</td><td>81.0</td><td>81.7</td><td>82.1</td></tr> <tr><td>6.93</td><td>80.6</td><td>81.4</td><td>82.1</td></tr> <tr><td>—</td><td>—</td><td>—</td><td>—</td></tr> <tr><td>—</td><td>—</td><td>—</td><td>—</td></tr> <tr><td>—</td><td>—</td><td>—</td><td>—</td></tr> <tr><td>—</td><td>—</td><td>—</td><td>—</td></tr> </tbody> </table>			Load Current [A]	Efficiency [%]			Input Volt. 85[V]	Input Volt. 100[V]	Input Volt. 132[V]	1.00	74.5	73.4	70.1	2.00	79.4	79.2	77.6	3.00	80.9	81.1	80.3	4.00	81.4	81.7	81.5	5.00	81.4	81.8	82.0	6.00	81.1	81.7	82.1	6.30	81.0	81.7	82.1	6.93	80.6	81.4	82.1	—	—	—	—	—	—	—	—	—	—	—	—	—	—	—	—
Load Current [A]	Efficiency [%]																																																											
	Input Volt. 85[V]	Input Volt. 100[V]	Input Volt. 132[V]																																																									
1.00	74.5	73.4	70.1																																																									
2.00	79.4	79.2	77.6																																																									
3.00	80.9	81.1	80.3																																																									
4.00	81.4	81.7	81.5																																																									
5.00	81.4	81.8	82.0																																																									
6.00	81.1	81.7	82.1																																																									
6.30	81.0	81.7	82.1																																																									
6.93	80.6	81.4	82.1																																																									
—	—	—	—																																																									
—	—	—	—																																																									
—	—	—	—																																																									
—	—	—	—																																																									
<p>Note: Slanted line shows the range of the rated load current</p> <p>(注)斜線は定格負荷電流範囲を示す。</p>																																																												



Model		LDA75F-12		Temperature		25°C																																	
Item		Hold-Up Time 出力保持時間		Testing Circuitry		Figure A																																	
Object		+12.0V 6.3A																																					
1. Graph				2. Values																																			
				<table border="1"> <thead> <tr> <th rowspan="2">Input Voltage [V]</th> <th colspan="2">Hold-Up Time [mS]</th> </tr> <tr> <th>Load 50%</th> <th>Load 100%</th> </tr> </thead> <tbody> <tr><td>75</td><td>20</td><td>9</td></tr> <tr><td>80</td><td>26</td><td>12</td></tr> <tr><td>85</td><td>31</td><td>14</td></tr> <tr><td>90</td><td>37</td><td>17</td></tr> <tr><td>100</td><td>50</td><td>24</td></tr> <tr><td>110</td><td>64</td><td>32</td></tr> <tr><td>120</td><td>80</td><td>40</td></tr> <tr><td>132</td><td>101</td><td>51</td></tr> <tr><td>140</td><td>115</td><td>58</td></tr> </tbody> </table>				Input Voltage [V]	Hold-Up Time [mS]		Load 50%	Load 100%	75	20	9	80	26	12	85	31	14	90	37	17	100	50	24	110	64	32	120	80	40	132	101	51	140	115	58
Input Voltage [V]	Hold-Up Time [mS]																																						
	Load 50%	Load 100%																																					
75	20	9																																					
80	26	12																																					
85	31	14																																					
90	37	17																																					
100	50	24																																					
110	64	32																																					
120	80	40																																					
132	101	51																																					
140	115	58																																					
<p>This duration covers from Shut-off of input voltage to the moment when output voltage descends to the rated range of voltage accuracy.</p> <p>Note: Slanted line shows the range of the rated input voltage.</p> <p>出力保持時間とは、入力電圧断から出力電圧が、定電圧精度の規格範囲を保持しているところまでの時間。</p> <p>(注)斜線は定格入力電圧範囲を示す。</p>																																							



Model		LDA75F-12		Temperature		25°C																																																				
Item		Instantaneous Interruption Compensation 瞬時停電保障		Testing Circuitry		Figure A																																																				
Object		+12.0V6.3A																																																								
1. Graph				2. Values																																																						
<p> △ Input Volt. 85 V □ Input Volt. 100 V ○ Input Volt. 132 V </p>				<table border="1"> <thead> <tr> <th rowspan="2">Load Current [A]</th> <th colspan="3">Time [mS]</th> </tr> <tr> <th>Input Volt. 85[V]</th> <th>Input Volt. 100[V]</th> <th>Input Volt. 132[V]</th> </tr> </thead> <tbody> <tr><td>0.00</td><td>—</td><td>—</td><td>—</td></tr> <tr><td>1.00</td><td>95</td><td>151</td><td>301</td></tr> <tr><td>2.00</td><td>48</td><td>81</td><td>163</td></tr> <tr><td>3.00</td><td>31</td><td>53</td><td>110</td></tr> <tr><td>4.00</td><td>22</td><td>39</td><td>81</td></tr> <tr><td>5.00</td><td>14</td><td>30</td><td>65</td></tr> <tr><td>6.00</td><td>14</td><td>23</td><td>53</td></tr> <tr><td>6.30</td><td>13</td><td>22</td><td>48</td></tr> <tr><td>6.93</td><td>11</td><td>20</td><td>45</td></tr> <tr><td>—</td><td>—</td><td>—</td><td>—</td></tr> <tr><td>—</td><td>—</td><td>—</td><td>—</td></tr> </tbody> </table>				Load Current [A]	Time [mS]			Input Volt. 85[V]	Input Volt. 100[V]	Input Volt. 132[V]	0.00	—	—	—	1.00	95	151	301	2.00	48	81	163	3.00	31	53	110	4.00	22	39	81	5.00	14	30	65	6.00	14	23	53	6.30	13	22	48	6.93	11	20	45	—	—	—	—	—	—	—	—
Load Current [A]	Time [mS]																																																									
	Input Volt. 85[V]	Input Volt. 100[V]	Input Volt. 132[V]																																																							
0.00	—	—	—																																																							
1.00	95	151	301																																																							
2.00	48	81	163																																																							
3.00	31	53	110																																																							
4.00	22	39	81																																																							
5.00	14	30	65																																																							
6.00	14	23	53																																																							
6.30	13	22	48																																																							
6.93	11	20	45																																																							
—	—	—	—																																																							
—	—	—	—																																																							
<p>This duration covers from Shut-off of input voltage to the moment when output voltage descends to the rated range of voltage accuracy.</p> <p>Note: Slanted line shows the range of the rated load current.</p>																																																										
<p>瞬時停電保障時間とは、出力電圧が定電圧精度の規格範囲を保持している瞬時停電時間をいう。</p> <p>(注)斜線は定格負荷電流範囲を示す。</p>																																																										



Model		LDA75F-12		Temperature	25°C																																															
Item		Load Regulation 静的負荷変動		Testing Circuitry	Figure A																																															
Object		+12.0V6.3A																																																		
1. Graph			△ Input Volt. 85 V □ Input Volt. 100 V ○ Input Volt. 132 V	2. Values																																																
			<table border="1"> <thead> <tr> <th rowspan="2">Load Current [A]</th> <th colspan="3">Output Voltage [V]</th> </tr> <tr> <th>Input Volt. 85[V]</th> <th>Input Volt. 100[V]</th> <th>Input Volt. 132[V]</th> </tr> </thead> <tbody> <tr><td>0.00</td><td>12.105</td><td>12.105</td><td>12.105</td></tr> <tr><td>1.00</td><td>12.104</td><td>12.104</td><td>12.104</td></tr> <tr><td>2.00</td><td>12.103</td><td>12.103</td><td>12.103</td></tr> <tr><td>3.00</td><td>12.102</td><td>12.102</td><td>12.102</td></tr> <tr><td>4.00</td><td>12.101</td><td>12.100</td><td>12.100</td></tr> <tr><td>5.00</td><td>12.100</td><td>12.099</td><td>12.099</td></tr> <tr><td>6.00</td><td>12.098</td><td>12.098</td><td>12.098</td></tr> <tr><td>6.30</td><td>12.098</td><td>12.098</td><td>12.098</td></tr> <tr><td>6.93</td><td>12.097</td><td>12.097</td><td>12.097</td></tr> <tr><td>—</td><td>—</td><td>—</td><td>—</td></tr> </tbody> </table>			Load Current [A]	Output Voltage [V]			Input Volt. 85[V]	Input Volt. 100[V]	Input Volt. 132[V]	0.00	12.105	12.105	12.105	1.00	12.104	12.104	12.104	2.00	12.103	12.103	12.103	3.00	12.102	12.102	12.102	4.00	12.101	12.100	12.100	5.00	12.100	12.099	12.099	6.00	12.098	12.098	12.098	6.30	12.098	12.098	12.098	6.93	12.097	12.097	12.097	—	—	—	—
Load Current [A]	Output Voltage [V]																																																			
	Input Volt. 85[V]	Input Volt. 100[V]	Input Volt. 132[V]																																																	
0.00	12.105	12.105	12.105																																																	
1.00	12.104	12.104	12.104																																																	
2.00	12.103	12.103	12.103																																																	
3.00	12.102	12.102	12.102																																																	
4.00	12.101	12.100	12.100																																																	
5.00	12.100	12.099	12.099																																																	
6.00	12.098	12.098	12.098																																																	
6.30	12.098	12.098	12.098																																																	
6.93	12.097	12.097	12.097																																																	
—	—	—	—																																																	
Note: Slanted line shows the range of the rated load current.																																																				
(注)斜線は定格負荷電流範囲を示す。																																																				



Model	LDA75F-12
Item	Ripple Voltage (by Load Current) リップル電圧 (負荷電流特性)
Object	+12.0V6.3A

Temperature 25°C
Testing Circuitry Figure A

1. Graph
[mV] □ --- Input Volt. 85V
 △ --- Input Volt. 132V

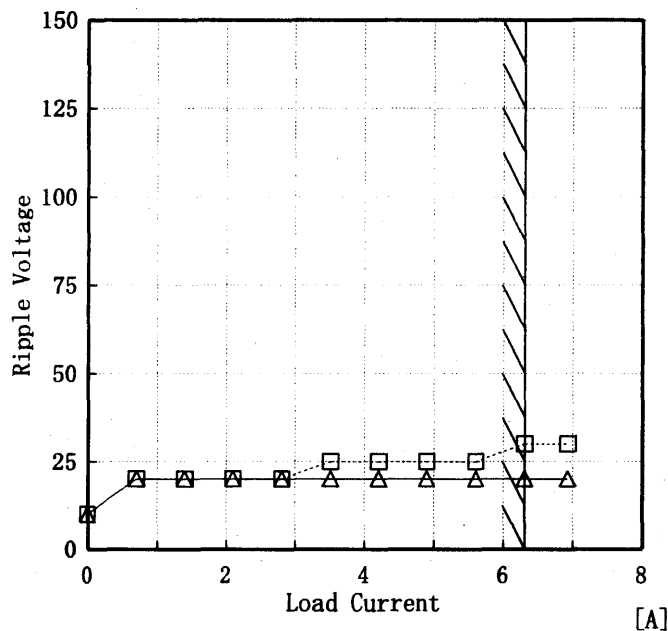

Ripple Voltage is shown as p-p in the figure below.

Note: Slanted line shows the range of the rated load current.

リップル電圧は、下図 p-p 値で示される。
(注) 斜線は定格負荷電流範囲を示す。

T1: Due to AC Input Line
入力商用周期
T2: Due to Switching
スイッチング周期

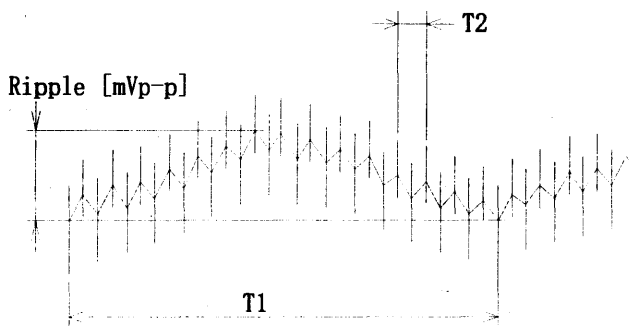

Fig. Complex Ripple Wave Form
図 リップル波形詳細図

2. Values

Load Current [A]	Input Volt. 85 [V]	Input Volt. 132 [V]
	Ripple Output Volt. [mV]	Ripple Output Volt. [mV]
0.00	10	10
0.70	20	20
1.40	20	20
2.10	20	20
2.80	20	20
3.50	25	20
4.20	25	20
4.90	25	20
5.60	25	20
6.30	30	20
6.93	30	20

COSEL

Model	LDA75F-12
Item	Ripple-Noise リップルノイズ
Object	+12.0V6.3A

Temperature	25°C
Testing Circuitry	Figure A

1. Graph
 [mV]
 □ Input Volt. 85V
 △ Input Volt. 132V

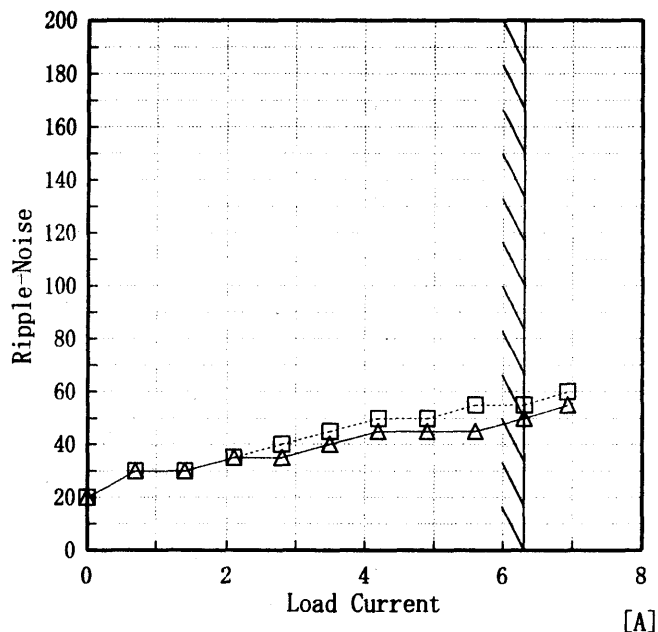

2. Values

Load current [A]	Input Volt. 85 [V]	Input Volt. 132 [V]
	Ripple-Noise [mV]	Ripple-Noise [mV]
0.00	20	20
0.70	30	30
1.40	30	30
2.10	35	35
2.80	40	35
3.50	45	40
4.20	50	45
4.90	50	45
5.60	55	45
6.30	55	50
6.93	60	55

Ripple-Noise is shown as p-p in the figure below.
 Note: Slanted line shows the range of the rated load current.

リップルノイズは、下図 p-p 値で示される。
 (注)斜線は定格負荷電流範囲を示す。

T1: Due to AC Input Line
 入力商用周期
 T2: Due to Switching
 スイッチング周期

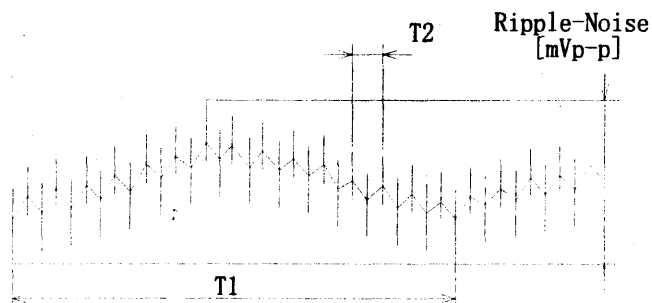

Fig. Complex Ripple Wave Form
 図 リップル波形詳細図



Model	LDA75F-12
Item	Overcurrent Protection 過電流保護
Object	+12.0V6.3A

Temperature 25°C
Testing Circuitry Figure A

1. Graph

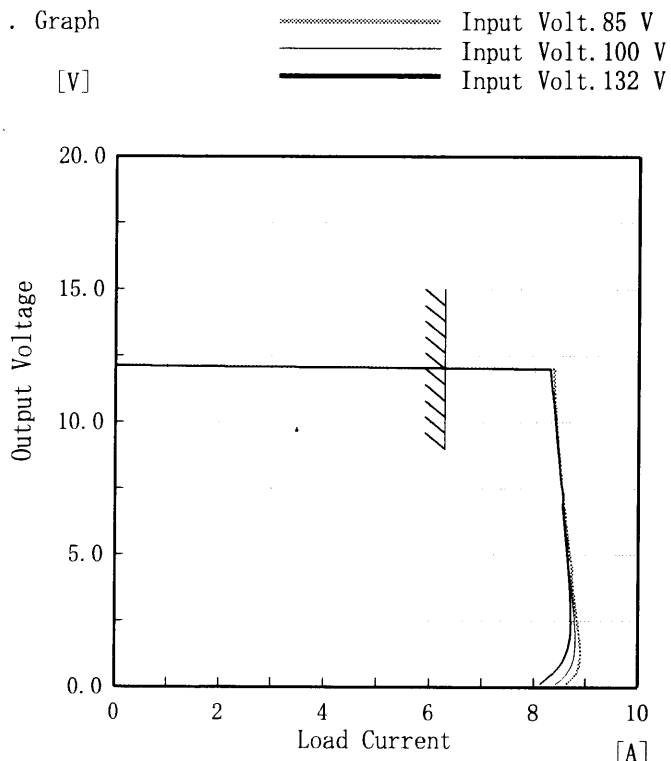

Note: Slanted line shows the range of the rated load current.

(注)斜線は定格負荷電流範囲を示す。

2. Values

Output Voltage [V]	Load Current [A]		
	Input Volt. 85[V]	Input Volt. 100[V]	Input Volt. 132[V]
12.00	8.39	8.31	8.30
11.40	8.38	8.33	8.33
10.80	8.40	8.35	8.36
9.60	8.44	8.41	8.43
8.40	8.50	8.48	8.48
7.20	8.56	8.54	8.57
6.00	8.63	8.60	8.59
4.80	8.71	8.66	8.65
3.60	8.76	8.73	8.70
2.40	8.85	8.79	8.72
1.20	8.90	8.79	8.63
0.00	8.63	8.41	8.11



COSEL																																																				
Model	LDA75F-12																																																			
Item	Overvoltage Protection 過電圧保護	Testing Circuitry Figure A																																																		
Object	+12.0V6.3A																																																			
<p>1. Graph</p> <div style="display: flex; justify-content: space-between; align-items: flex-start;"> <div style="width: 45%;"> </div> <div style="width: 45%;"> <p>2. Values</p> <table border="1" style="width: 100%; border-collapse: collapse; text-align: center;"> <thead> <tr> <th rowspan="2">Ambient Temperature [°C]</th> <th colspan="3">Operating Point [V]</th> </tr> <tr> <th>Input Volt. 85[V]</th> <th>Input Volt. 100[V]</th> <th>Input Volt. 132[V]</th> </tr> </thead> <tbody> <tr><td>-20</td><td>15.12</td><td>15.13</td><td>15.13</td></tr> <tr><td>-10</td><td>15.18</td><td>15.19</td><td>15.19</td></tr> <tr><td>0</td><td>15.30</td><td>15.30</td><td>15.30</td></tr> <tr><td>10</td><td>15.42</td><td>15.36</td><td>15.36</td></tr> <tr><td>20</td><td>15.48</td><td>15.48</td><td>15.48</td></tr> <tr><td>25</td><td>15.54</td><td>15.54</td><td>15.54</td></tr> <tr><td>30</td><td>15.60</td><td>15.60</td><td>15.60</td></tr> <tr><td>40</td><td>15.66</td><td>15.66</td><td>15.66</td></tr> <tr><td>50</td><td>15.77</td><td>15.78</td><td>15.78</td></tr> <tr><td>60</td><td>15.89</td><td>15.89</td><td>15.89</td></tr> <tr><td>—</td><td>—</td><td>—</td><td>—</td></tr> </tbody> </table> </div> </div>		Ambient Temperature [°C]	Operating Point [V]			Input Volt. 85[V]	Input Volt. 100[V]	Input Volt. 132[V]	-20	15.12	15.13	15.13	-10	15.18	15.19	15.19	0	15.30	15.30	15.30	10	15.42	15.36	15.36	20	15.48	15.48	15.48	25	15.54	15.54	15.54	30	15.60	15.60	15.60	40	15.66	15.66	15.66	50	15.77	15.78	15.78	60	15.89	15.89	15.89	—	—	—	—
Ambient Temperature [°C]	Operating Point [V]																																																			
	Input Volt. 85[V]	Input Volt. 100[V]	Input Volt. 132[V]																																																	
-20	15.12	15.13	15.13																																																	
-10	15.18	15.19	15.19																																																	
0	15.30	15.30	15.30																																																	
10	15.42	15.36	15.36																																																	
20	15.48	15.48	15.48																																																	
25	15.54	15.54	15.54																																																	
30	15.60	15.60	15.60																																																	
40	15.66	15.66	15.66																																																	
50	15.77	15.78	15.78																																																	
60	15.89	15.89	15.89																																																	
—	—	—	—																																																	
<p style="text-align: center;">Load 0%</p> <p>Note: Slanted line shows the range of the rated ambient temperature.</p> <p>(注)斜線は定格周囲温度範囲を示す。</p>																																																				

COSEL

Model	LDA75F-12	Temperature	25°C
Item	Inrush Current 突入電流	Testing Circuitry	Figure A
Object	_____		

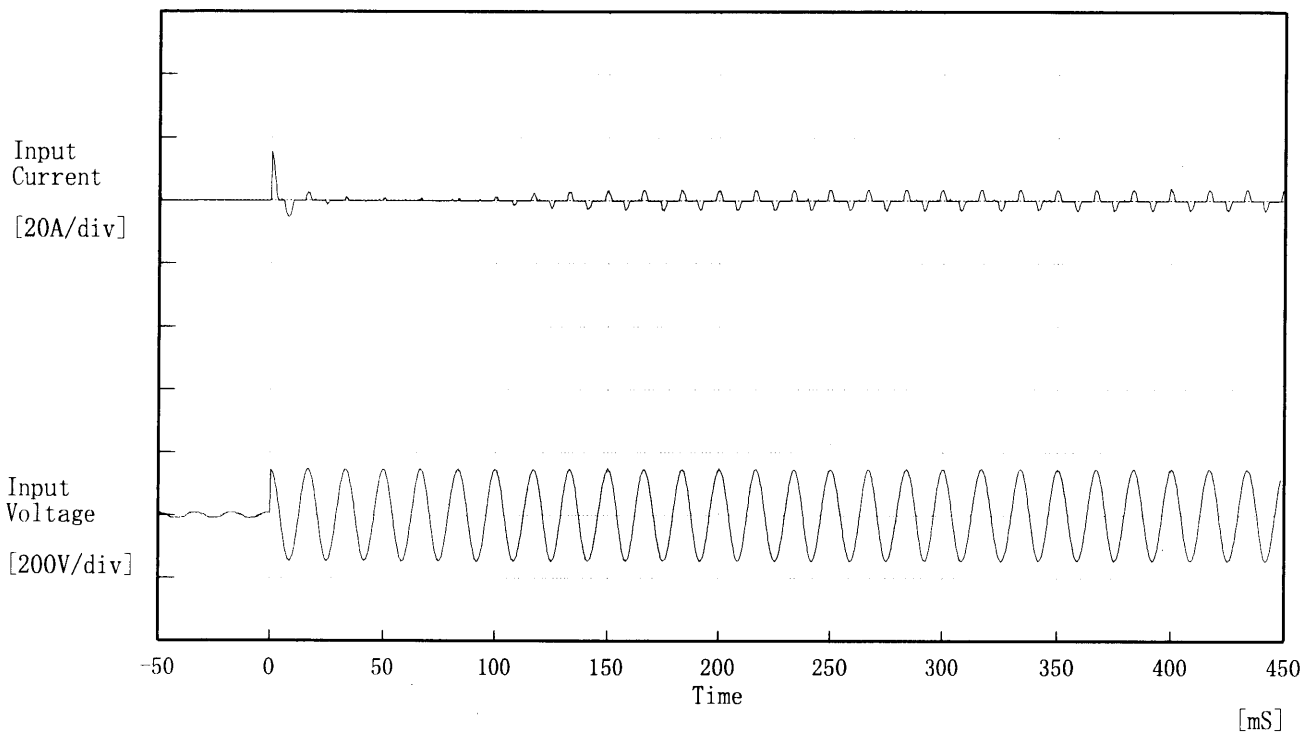

Input Voltage 100 V
 Frequency 60 Hz
 Load 100 %
 Inrush Current
 ① 15.51 [A]
 ② 3.91 [A]

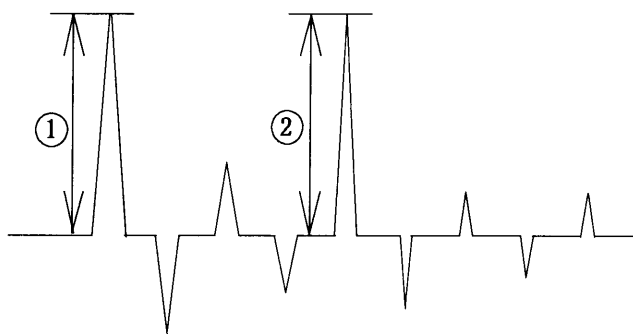



Model		LDA75F-12	Temperature 25°C Testing Circuitry Figure A
Item		Dynamic Load Responce 動的負荷變動	
Object		+12.0V6.3A	

Input Volt. 100 V
Cycle 1000 mS



Load 0% ←→
Load 100 %

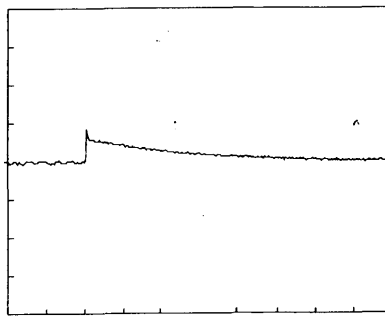
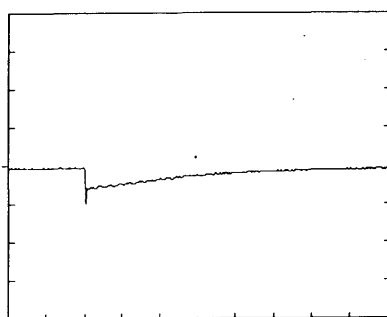

Load 0% ←→
Load 50 %

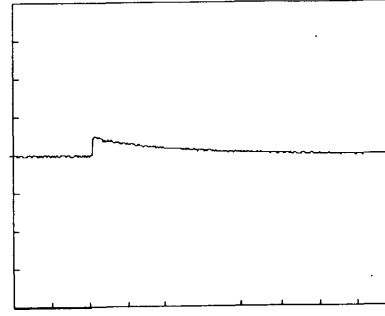
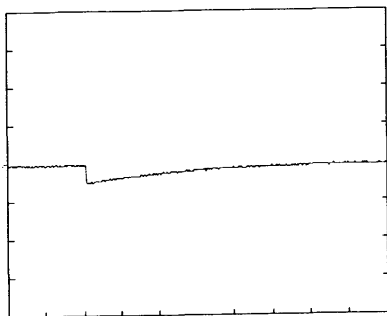

100 mV/div

10 mS/div

COSEL

Model	LDA75F-12	Temperature	25°C
Item	Rise and Fall Time 立上り、立下り時間	Testing Circuitry	Figure A
Object	+12.0V6.3A		

1. Graph

Input Volt. 85 V

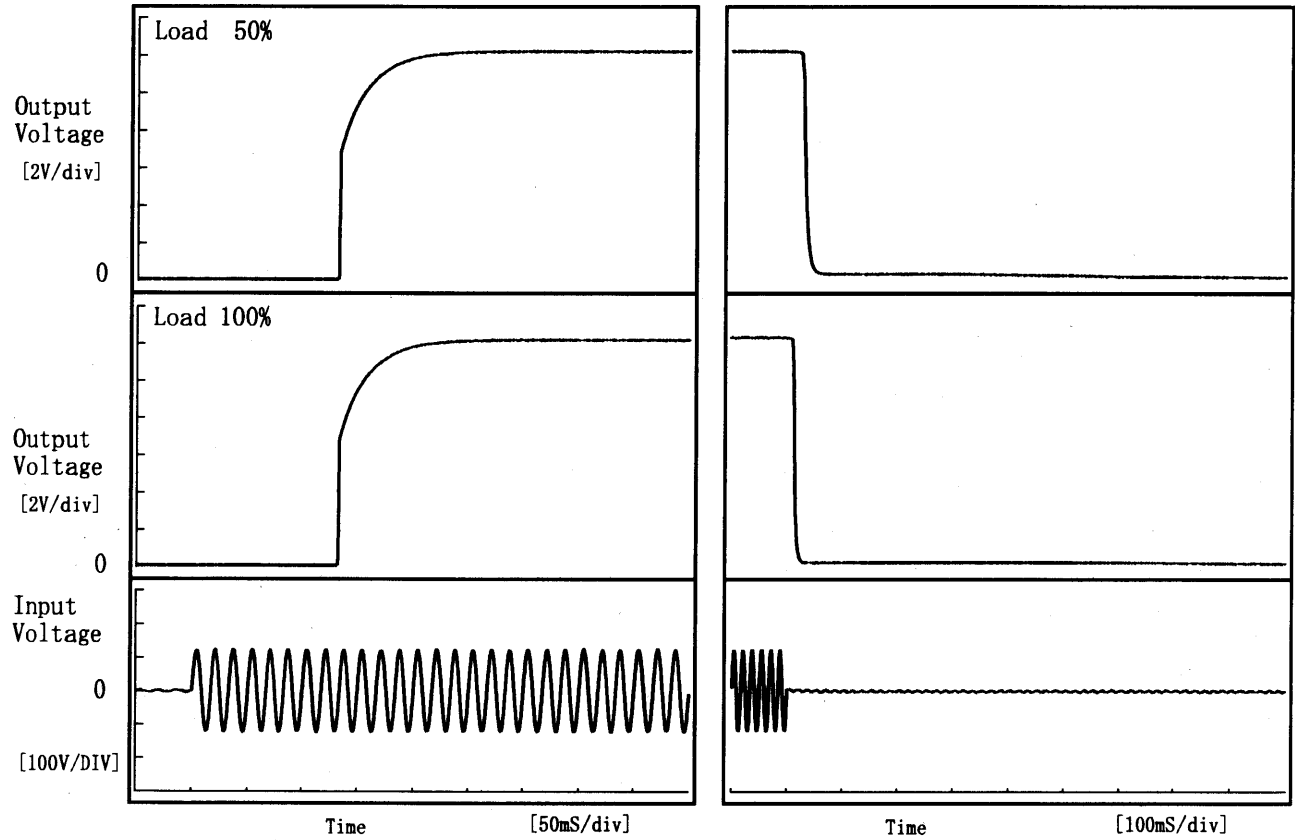

2. Values

[mS]

Load \ Time	T _d	T _r	T _s	T _h	T _f
50 %	131.5	35.3	166.8	31.0	13.0
100 %	131.5	36.0	167.5	14.5	7.0

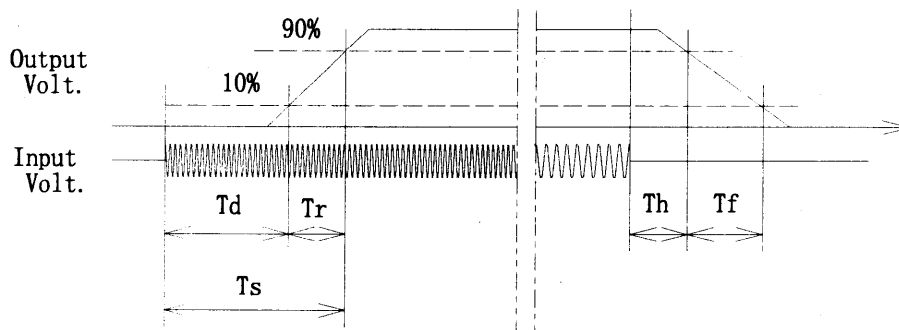



Model	LDA75F-12
Item	Ambient Temperature Drift 周囲温度変動
Object	+12.0V6.3A

Testing Circuitry Figure A

1. Graph

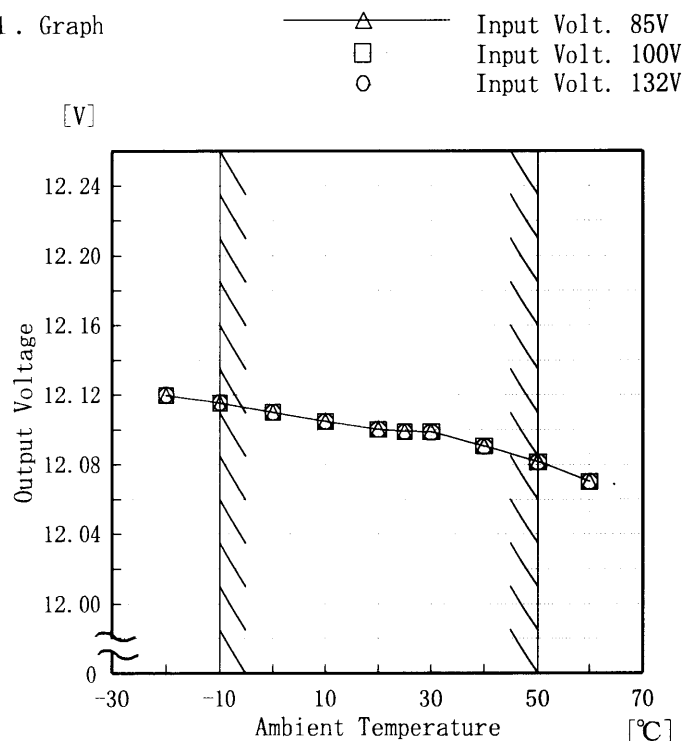

Note: Slanted line shows the range of the rated ambient temperature.

(注) 斜線は定格周囲温度範囲を示す。

2. Values

Temperature [°C]	Output Voltage [V]		
	Input Volt. 85[V]	Input Volt. 100[V]	Input Volt. 132[V]
-20	12.120	12.120	12.120
-10	12.116	12.115	12.116
0	12.110	12.110	12.110
10	12.105	12.105	12.105
20	12.100	12.100	12.100
25	12.099	12.099	12.099
30	12.099	12.099	12.099
40	12.091	12.091	12.091
50	12.082	12.081	12.081
60	12.070	12.070	12.070
—	—	—	—



Model	LDA75F-12
Item	Minimum Input Voltage for Regulated Output Voltage 最低レギュレーション電圧
Object	+12.0V6.3A

Testing Circuitry Figure A

1. Graph

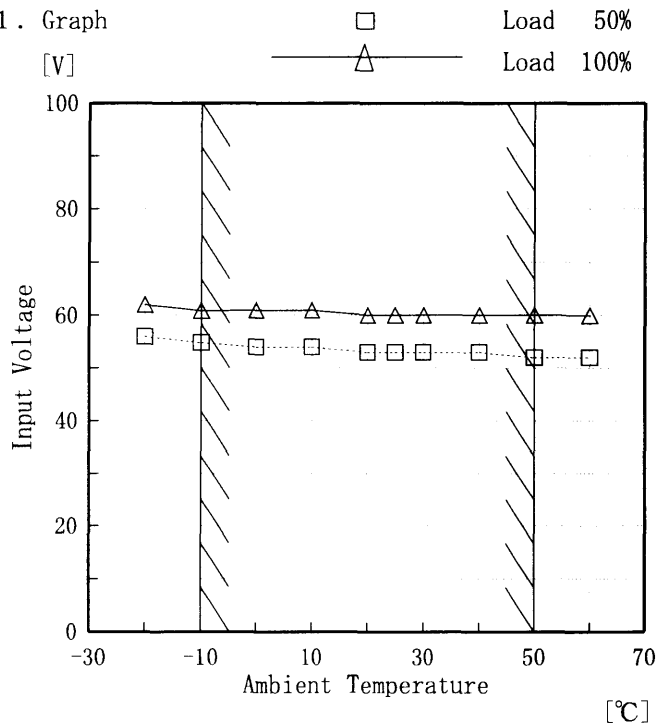

2. Values

Ambient Temperature [°C]	Input Voltage [V]	
	Load 50%	Load 100%
-20	56	62
-10	55	61
0	54	61
10	54	61
20	53	60
25	53	60
30	53	60
40	53	60
50	52	60
60	52	60
—	—	—

Note: Slanted line shows the range of the rated ambient temperature.

(注)斜線は定格周囲温度範囲を示す。



Model	LDA75F-12
Item	Ripple Voltage (by Ambient Temp.) リップル電圧 (周囲温度特性)
Object	+12.0V6.3A

Testing Circuitry Figure A

1. Graph □ Load 50%
△ Load 100%

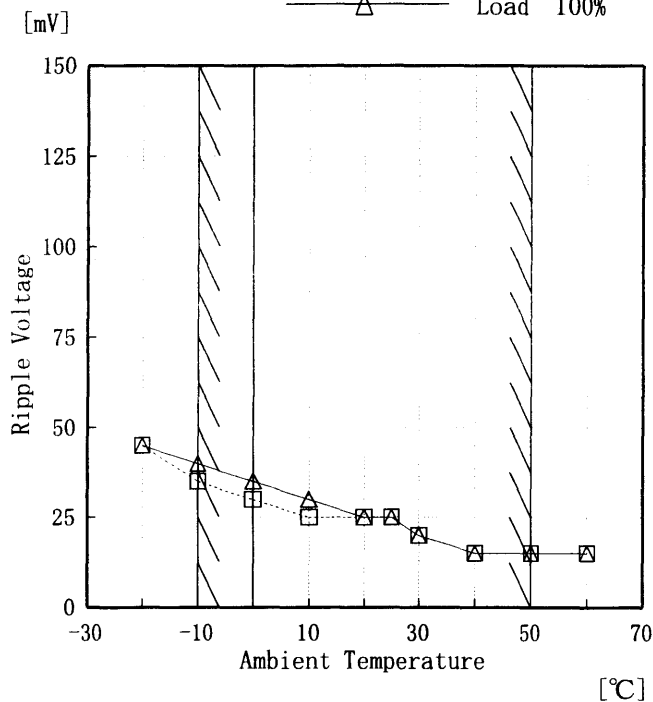

Input Volt. 100 V

Note: Slanted line shows the range of the rated ambient temperature.

(注) 斜線は定格周囲温度範囲を示す。

2. Values

Ambient Temp. [°C]	Load 50%	Load 100%
	Ripple Output Volt. [mV]	Ripple Output Volt. [mV]
-20	45	45
-10	35	40
0	30	35
10	25	30
20	25	25
25	25	25
30	20	20
40	15	15
50	15	15
60	15	15
—	—	—



COSEL																								
Model	LDA75F-12																							
Item	Time Lapse Drift 経時ドリフト	Temperature 25°C Testing Circuitry Figure A																						
Object	+12.0V6.3A																							
<p>1. Graph</p> <p style="text-align: center;">Time [H]</p> <p>Input Volt. 100V Load 100%</p>		<p>2. Values</p> <table border="1"> <thead> <tr> <th>Time since start [H]</th> <th>Output Voltage [V]</th> </tr> </thead> <tbody> <tr><td>0.0</td><td>12.101</td></tr> <tr><td>0.5</td><td>12.091</td></tr> <tr><td>1.0</td><td>12.091</td></tr> <tr><td>2.0</td><td>12.091</td></tr> <tr><td>3.0</td><td>12.091</td></tr> <tr><td>4.0</td><td>12.091</td></tr> <tr><td>5.0</td><td>12.091</td></tr> <tr><td>6.0</td><td>12.091</td></tr> <tr><td>7.0</td><td>12.091</td></tr> <tr><td>8.0</td><td>12.091</td></tr> </tbody> </table>	Time since start [H]	Output Voltage [V]	0.0	12.101	0.5	12.091	1.0	12.091	2.0	12.091	3.0	12.091	4.0	12.091	5.0	12.091	6.0	12.091	7.0	12.091	8.0	12.091
Time since start [H]	Output Voltage [V]																							
0.0	12.101																							
0.5	12.091																							
1.0	12.091																							
2.0	12.091																							
3.0	12.091																							
4.0	12.091																							
5.0	12.091																							
6.0	12.091																							
7.0	12.091																							
8.0	12.091																							



Model		LDA75F-12	Testing Circuitry Figure A
Item	Output Voltage Accuracy	定電圧精度	
Object	+12.0V6.3A		

Output Voltage Accuracy

This is defined as the value of the output voltage, regulation load, ambient temperature and input voltage varied at random in the range as specified below.

Temperature : -10~50 °C

Input Voltage : 85~132 V

Load Current : 0~6.3 A

* Output Voltage Accuracy = $\pm (\text{Maximum of Output Voltage} - \text{Minimum of Output Voltage}) / 2$

* Output Voltage Accuracy (Ration) = $\frac{\text{Output Voltage Accuracy}}{\text{Rated Output Voltage}} \times 100$

定電圧精度

周囲温度、入力電圧、負荷電流を下記仕様内で、任意に変動させたときの出力電圧の変動をいう。

周囲温度 -10~50 °C

入力電圧 85~132 V

負荷電流 0~6.3 A

* 定電圧精度(変動値) = $\pm (\text{出力電圧の最高値} - \text{出力電圧の最低値}) / 2$

* 定電圧精度(変動率) = $\frac{\text{変動値}}{\text{定格出力電圧}} \times 100$

Item	Temperature [°C]	Input Voltage [V]	Output Current [A]	Output Voltage [V]	Output Voltage Accuracy [mV]	Output Voltage Accuracy (Ration) [%]
Maximum Voltage	-10	85	0.0	12.122	±22	±0.2
Minimum Voltage	50	132	6.3	12.079		



COSEL		
Model	LDA75F-12	
Item	Condensation 結露特性	Testing Circuitry Figure A
Object	+12.0V6.3A	

1. Condensation test

Testing procedure is as follows.

- ① Keeping and cooling the unit in a tank at -10°C for an hour with the input off.
- ② Taking it out of the tank and dewing itself in a room where the temperature is 25°C and the humidity is 40%RH.
- ③ Testing electrical characteristics of the unit to confirm there be no fault.

1. 結露特性試験

入力を切った状態で、恒温槽で-10℃に冷却しておき、約1時間後に恒温槽から取り出し、室温25℃、湿度40%RHの状態におき結露させ、その電気的特性の測定を行い、異常のないことを確認する。

2. Values

Item	Data	Testing Conditions
Output Voltage [V]	12.1	Input Volt.: 100V, Load Current:6.3A
Line Regulation [mV]	5	Input Volt.: 85~132V, Load Current:6.3A
Load Regulation [mV]	9	Input Volt.: 100V, Load Current:0.0~6.3A



Model		LDA75F-12	Temperature 25°C Testing Circuitry Figure B
Item		Leakage Current 漏洩電流	
Object		_____	

1. Results

Standards	Leakage Current [mA]		
	Input Volt. 85 [V]	Input Volt. 100 [V]	Input Volt. 132 [V]
(A) DENTORI	0.14	0.17	0.22
(B) IEC60950	0.14	0.16	0.20

Standards	Leakage Current [mA]		
	Input Volt. 170 [V]	Input Volt. 230 [V]	Input Volt. 264 [V]
(B) IEC60950	—	—	—

2. Condition

Leakage current value is concluded after measuring both phases of AC input and by choosing the larger one.

交流入力 of 両相について測定し、その大きい方を漏洩電流測定値とする。



Model		LDA75F-12	Temperature 25°C Testing Circuitry Figure C
Item		Line Noise Tolerance 入力雑音耐量	
Object		+12.0V6.3A	

1. Results

Pulse Width [nS]	MODE	No protection failure should occur 保護回路の誤動作がない	DC-like Regulation of Output Voltage 出力電圧の直流的変動
50	COMMON	OK	no fluctuation
	NORMAL	OK	no fluctuation
1000	COMMON	OK	no fluctuation
	NORMAL	OK	no fluctuation

2. Conditions

Input Voltage : 100 V
 Pulse Voltage : 2000 V
 Pulse Cycle : 10 mS
 Pulse Input Duration : 1 min. or more
 Load : 100 %



Model		LDA75F-12	Temperature		25°C
Item		Conducted Emission 雑音端子電圧	Testing Circuitry		Figure D
Object					

1. Graph

Remarks

Input Volt. 100 V (VCCI Class B)
 120 V (FCC Class B)
 Load 100 %

規格 1 : [VCCI] Class B(平均値)
 規格 2 : [VCCI] Class B(QP)

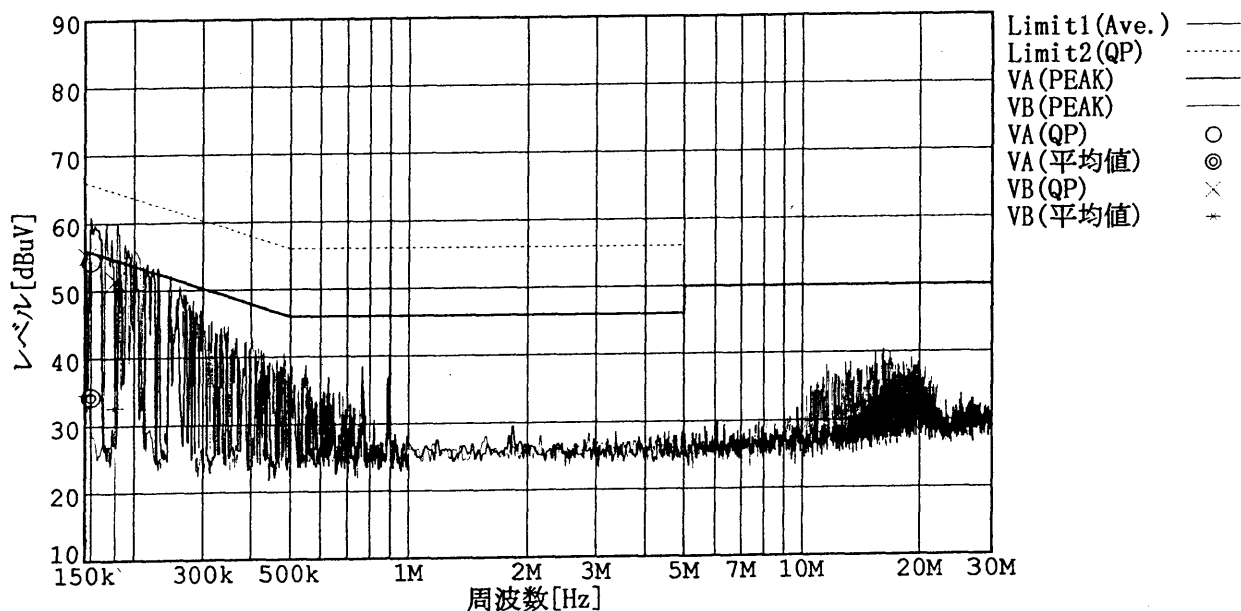

規格 1 : [FCC Part15] Class B

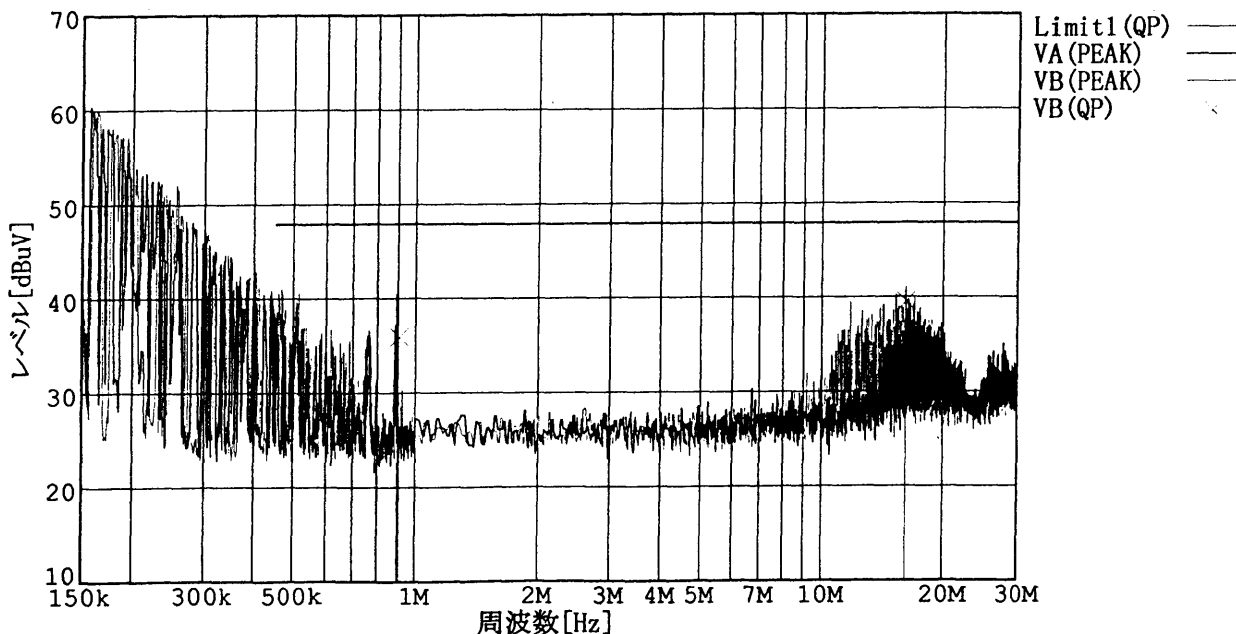

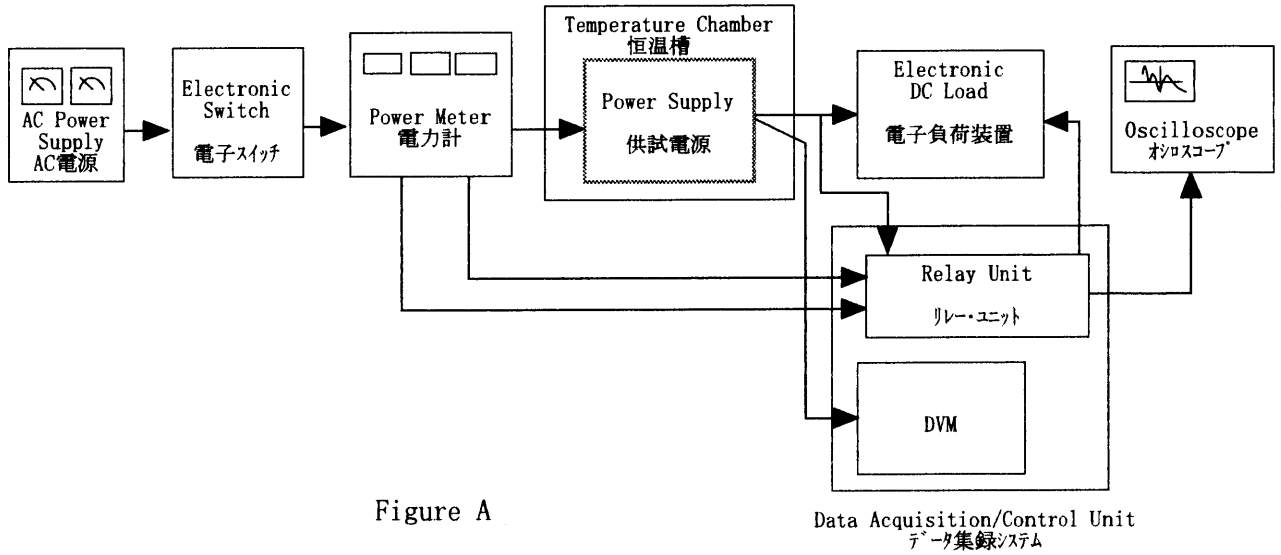

Figure A

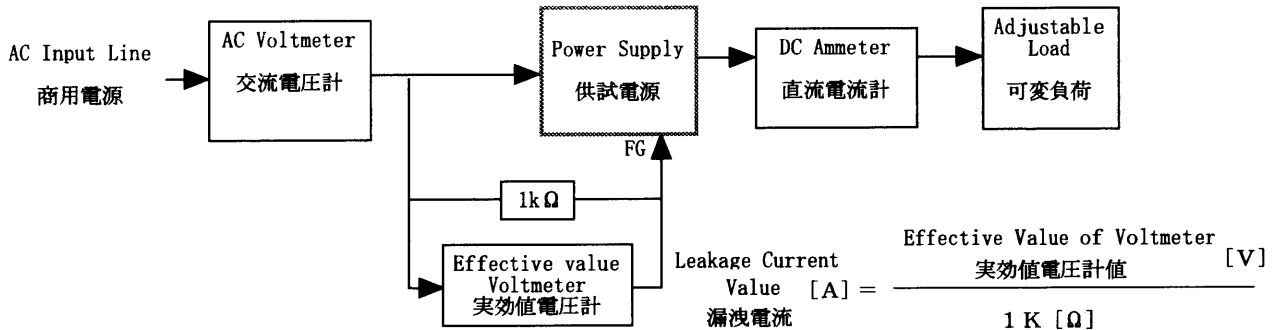

Figure B (DENTORI)

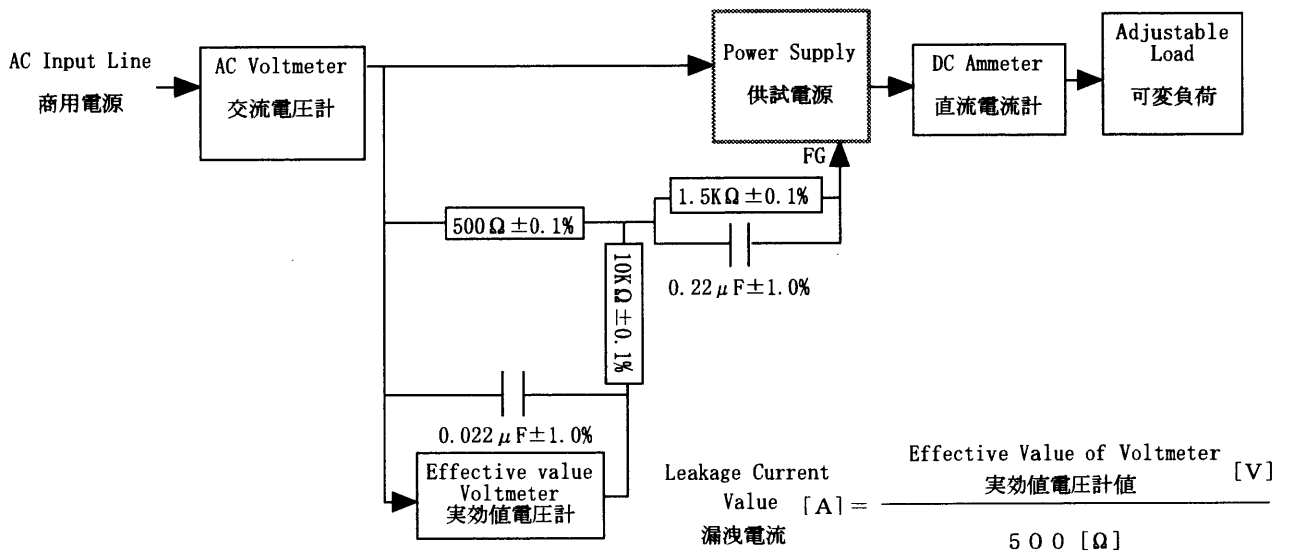

Figure B (IEC 60950)

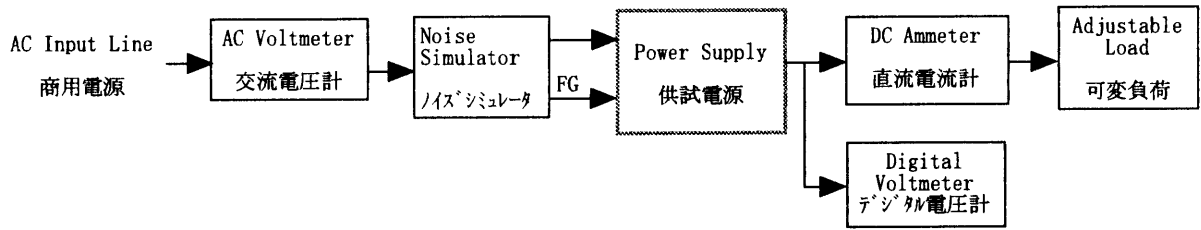

Figure C

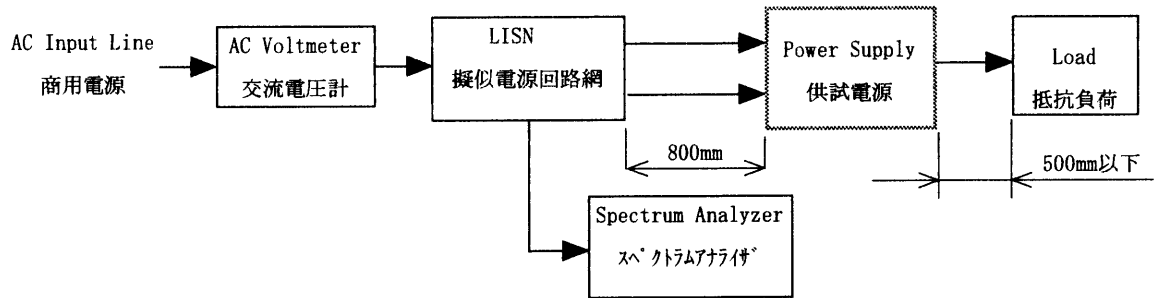

Figure D

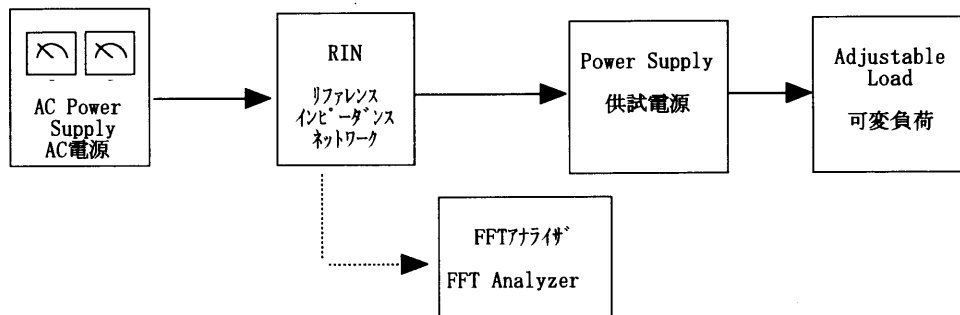

Figure E