



TEST DATA OF LDA10F-5 (200V INPUT)

Regulated DC Power Supply

Date : June 18. 1999

Approved by : *H. Yamaguchi*
Design Manager

Prepared by : *J. Ashihara*
Design Engineer

コーセル株式会社

COSEL CO., LTD.



CONTENTS

| | |
|--|----|
| 1. Line Regulation | 1 |
| 静的入力変動 | |
| 2. Input Current (by Load Current) | 2 |
| 入力電流 (負荷特性) | |
| 3. Input Power (by Load Current) | 3 |
| 入力電力 (負荷特性) | |
| 4. Efficiency (by Input Voltage) | 4 |
| 効率 (入力電圧特性) | |
| 5. Efficiency (by Load Current) | 5 |
| 効率 (負荷特性) | |
| 6. Hold-Up Time | 6 |
| 出力保持時間 | |
| 7. Instantaneous Interruption Compensation | 7 |
| 瞬時停電保障 | |
| 8. Load Regulation | 8 |
| 静的負荷変動 | |
| 9. Ripple Voltage (by Load Current) | 9 |
| リップル電圧 (負荷特性) | |
| 10. Ripple-Noise | 10 |
| リップルノイズ | |
| 11. Overcurrent Protection | 11 |
| 過電流保護 | |
| 12. Inrush Current | 12 |
| 突入電流 | |
| 13. Dynamic Load Responce | 13 |
| 動的負荷変動 | |
| 14. Rise and Fall Time | 14 |
| 立上り、立下がり時間 | |
| 15. Ambient Temperature Drift | 15 |
| 周囲温度変動 | |
| 16. Minimum Input Voltage for Regulated Output Voltage | 16 |
| 最低レギュレーション電圧 | |
| 17. Ripple Voltage (by Ambient Temperature) | 17 |
| リップル電圧 (周囲温度特性) | |
| 18. Time Lapse Drift | 18 |
| 経時ドリフト | |
| 19. Output Voltage Accuracy | 19 |
| 定電圧精度 | |
| 20. Condensation | 20 |
| 結露特性 | |
| 21. Leakage Current | 21 |
| 漏洩電流 | |
| 22. Line Noise Tolerance | 22 |
| 入力雑音耐量 | |
| 23. Conducted Emission | 23 |
| 雑音端子電圧 | |
| 24. Figure of Testing Circuitry | 24 |
| 測定回路図 | |

(Final Page 25)



| Model | | LDA10F-5 | Temperature | 25°C | | | | | | | | | | | | | | | | | | | | | | | | | | | | | | | | |
|---|--------------------|---|-------------------|----------|-------------------|--------------------|--|----------|-----------|-----|-------|-------|-----|-------|-------|-----|-------|-------|-----|-------|-------|-----|-------|-------|-----|-------|-------|-----|-------|-------|-----|-------|-------|-----|-------|-------|
| Item | | Line Regulation 静的入力変動 | Testing Circuitry | Figure A | | | | | | | | | | | | | | | | | | | | | | | | | | | | | | | | |
| Object | | +5.0V2A | | | | | | | | | | | | | | | | | | | | | | | | | | | | | | | | | | |
| 1. Graph | | <p>-----□----- Load 50%</p> <p>-----△----- Load 100%</p> | 2. Values | | | | | | | | | | | | | | | | | | | | | | | | | | | | | | | | | |
| <p>[V]</p> <p>Output Voltage</p> <p>Input Voltage [V]</p> | | <table border="1"> <thead> <tr> <th rowspan="2">Input Voltage [V]</th> <th colspan="2">Output Voltage [V]</th> </tr> <tr> <th>Load 50%</th> <th>Load 100%</th> </tr> </thead> <tbody> <tr><td>150</td><td>5.150</td><td>5.146</td></tr> <tr><td>160</td><td>5.150</td><td>5.146</td></tr> <tr><td>170</td><td>5.150</td><td>5.146</td></tr> <tr><td>180</td><td>5.150</td><td>5.147</td></tr> <tr><td>200</td><td>5.150</td><td>5.147</td></tr> <tr><td>220</td><td>5.150</td><td>5.147</td></tr> <tr><td>240</td><td>5.151</td><td>5.147</td></tr> <tr><td>264</td><td>5.151</td><td>5.148</td></tr> <tr><td>280</td><td>5.151</td><td>5.148</td></tr> </tbody> </table> | | | Input Voltage [V] | Output Voltage [V] | | Load 50% | Load 100% | 150 | 5.150 | 5.146 | 160 | 5.150 | 5.146 | 170 | 5.150 | 5.146 | 180 | 5.150 | 5.147 | 200 | 5.150 | 5.147 | 220 | 5.150 | 5.147 | 240 | 5.151 | 5.147 | 264 | 5.151 | 5.148 | 280 | 5.151 | 5.148 |
| Input Voltage [V] | Output Voltage [V] | | | | | | | | | | | | | | | | | | | | | | | | | | | | | | | | | | | |
| | Load 50% | Load 100% | | | | | | | | | | | | | | | | | | | | | | | | | | | | | | | | | | |
| 150 | 5.150 | 5.146 | | | | | | | | | | | | | | | | | | | | | | | | | | | | | | | | | | |
| 160 | 5.150 | 5.146 | | | | | | | | | | | | | | | | | | | | | | | | | | | | | | | | | | |
| 170 | 5.150 | 5.146 | | | | | | | | | | | | | | | | | | | | | | | | | | | | | | | | | | |
| 180 | 5.150 | 5.147 | | | | | | | | | | | | | | | | | | | | | | | | | | | | | | | | | | |
| 200 | 5.150 | 5.147 | | | | | | | | | | | | | | | | | | | | | | | | | | | | | | | | | | |
| 220 | 5.150 | 5.147 | | | | | | | | | | | | | | | | | | | | | | | | | | | | | | | | | | |
| 240 | 5.151 | 5.147 | | | | | | | | | | | | | | | | | | | | | | | | | | | | | | | | | | |
| 264 | 5.151 | 5.148 | | | | | | | | | | | | | | | | | | | | | | | | | | | | | | | | | | |
| 280 | 5.151 | 5.148 | | | | | | | | | | | | | | | | | | | | | | | | | | | | | | | | | | |
| <p>Note: Slanted line shows the range of the rated input voltage.</p> <p>(注)斜線は定格入力電圧範囲を示す。</p> | | | | | | | | | | | | | | | | | | | | | | | | | | | | | | | | | | | | |



| | |
|--------|--|
| Model | LDA10F-5 |
| Item | Input Current (by Load Current) 入力電流 (負荷特性) |
| Output | _____ |

Temperature 25°C
Testing Circuitry Figure A

1. Graph

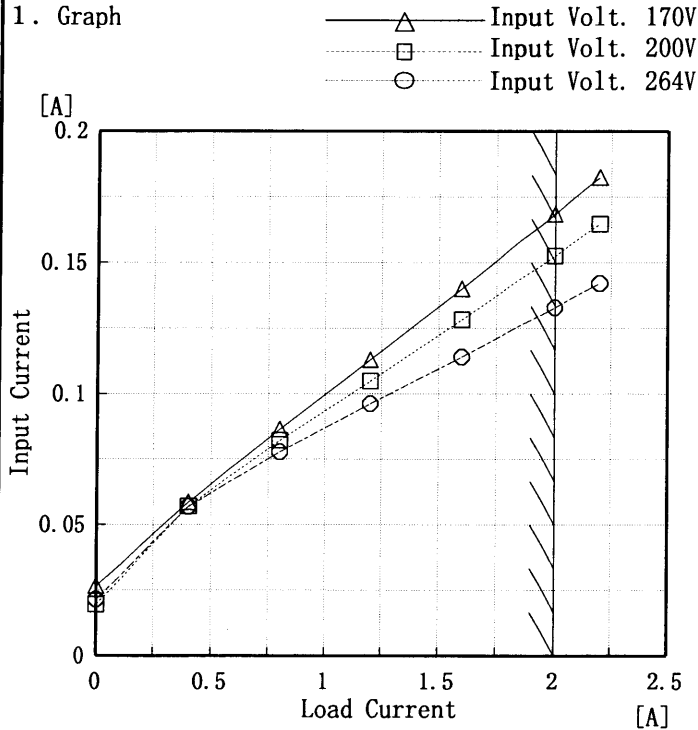

2. Values

| Load Current [A] | Input Current [A] | | |
|------------------|--------------------|--------------------|--------------------|
| | Input Volt. 170[V] | Input Volt. 200[V] | Input Volt. 264[V] |
| 0.0 | 0.027 | 0.020 | 0.021 |
| 0.4 | 0.059 | 0.057 | 0.057 |
| 0.8 | 0.087 | 0.082 | 0.078 |
| 1.2 | 0.113 | 0.105 | 0.096 |
| 1.6 | 0.140 | 0.128 | 0.114 |
| 2.0 | 0.169 | 0.153 | 0.133 |
| 2.2 | 0.183 | 0.165 | 0.142 |
| — | — | — | — |
| — | — | — | — |
| — | — | — | — |
| — | — | — | — |
| — | — | — | — |

Note: Slanted line shows the range of the rated load current

(注) 斜線は定格負荷電流範囲を示す。



| | |
|--------|--|
| Model | LDA10F-5 |
| Item | Input Power (by Load Current) 入力電力 (負荷特性) |
| Output | ————— |

Temperature 25°C
Testing Circuitry Figure A

1. Graph

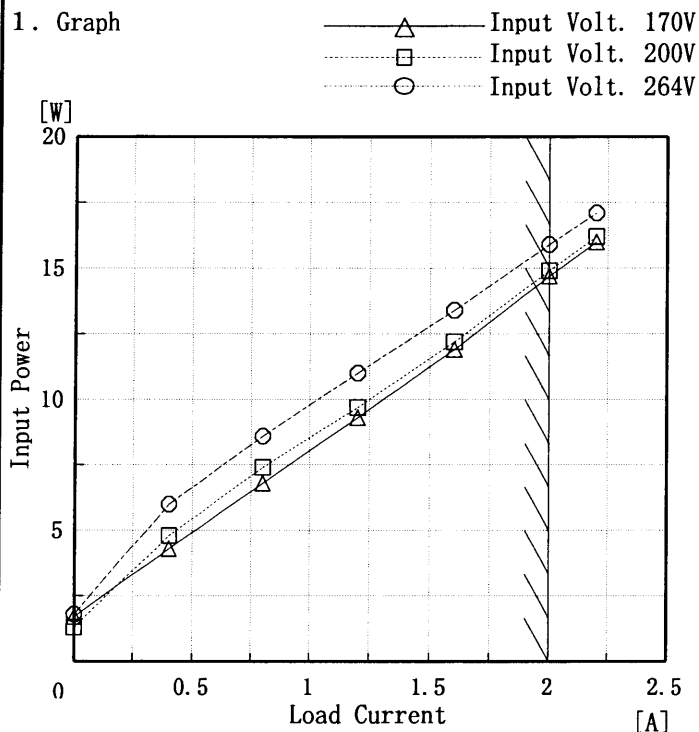

2. Values

| Load Current [A] | Input Power [W] | | |
|---------------------|-----------------------|-----------------------|-----------------------|
| | Input Volt. 170[V] | Input Volt. 200[V] | Input Volt. 264[V] |
| 0.0 | 1.70 | 1.30 | 1.80 |
| 0.4 | 4.30 | 4.80 | 6.00 |
| 0.8 | 6.80 | 7.40 | 8.60 |
| 1.2 | 9.30 | 9.70 | 11.00 |
| 1.6 | 11.90 | 12.20 | 13.40 |
| 2.0 | 14.70 | 14.90 | 15.90 |
| 2.2 | 16.00 | 16.20 | 17.10 |
| — | — | — | — |
| — | — | — | — |
| — | — | — | — |
| — | — | — | — |
| — | — | — | — |

Note: Slanted line shows the range of the rated load current

(注)斜線は定格負荷電流範囲を示す。



| | | | |
|--------|---------------|-------------------|----------|
| Model | LDA10F-5 | Temperature | 25°C |
| Item | Efficiency 効率 | Testing Circuitry | Figure A |
| Object | _____ | | |

1. Graph

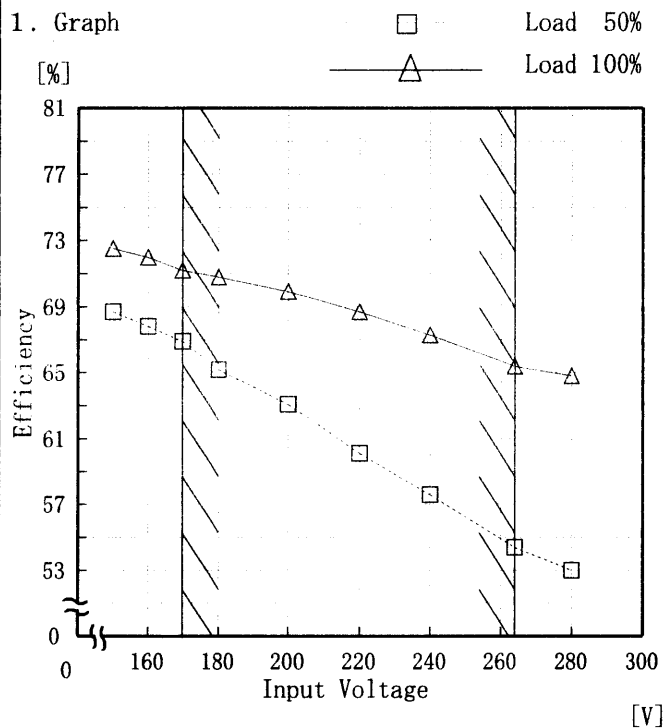

Note: Slanted line shows the range of the rated input voltage.

(注)斜線は定格入力電圧範囲を示す。

2. Values

| Input Voltage [V] | Efficiency [%] | |
|-------------------|----------------|-----------|
| | Load 50% | Load 100% |
| 150 | 68.7 | 72.5 |
| 160 | 67.8 | 72.0 |
| 170 | 66.9 | 71.2 |
| 180 | 65.2 | 70.8 |
| 200 | 63.1 | 69.9 |
| 220 | 60.1 | 68.7 |
| 240 | 57.6 | 67.3 |
| 264 | 54.4 | 65.4 |
| 280 | 53.0 | 64.8 |



| | |
|--------|---|
| Model | LDA10F-5 |
| Item | Efficiency (by Load Current) 効率 (負荷電流特性) |
| Output | ————— |

Temperature 25°C
Testing Circuitry Figure A

1. Graph

—△— Input Volt. 170V
 - - -□- - - Input Volt. 200V
 - - -○- - - Input Volt. 264V

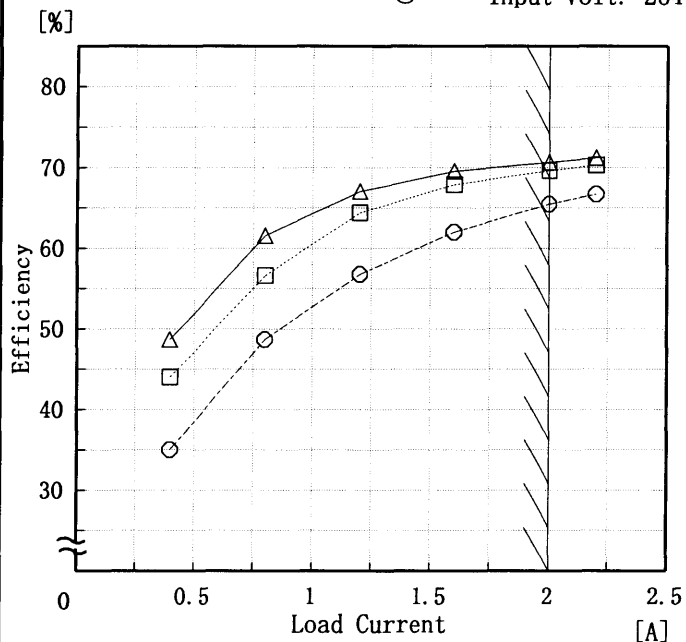

Note: Slanted line shows the range of the rated load current

(注) 斜線は定格負荷電流範囲を示す。

2. Values

| Load Current [A] | Efficiency [%] | | |
|------------------|--------------------|--------------------|--------------------|
| | Input Volt. 170[V] | Input Volt. 200[V] | Input Volt. 264[V] |
| 0.4 | 48.7 | 44.0 | 35.0 |
| 0.8 | 61.6 | 56.6 | 48.7 |
| 1.2 | 67.1 | 64.4 | 56.8 |
| 1.6 | 69.6 | 67.9 | 62.0 |
| 2.0 | 70.7 | 69.6 | 65.5 |
| 2.2 | 71.2 | 70.3 | 66.7 |
| — | — | — | — |
| — | — | — | — |
| — | — | — | — |
| — | — | — | — |
| — | — | — | — |
| — | — | — | — |
| — | — | — | — |



| <p>Model LDA10F-5</p> <p>Item Hold-Up Time 出力保持時間</p> <p>Object +5.0V2A</p> | | <p>Temperature 25°C</p> <p>Testing Circuitry Figure A</p> | | | | | | | | | | | | | | | | | | | | | | | | | | | | | | | | |
|--|-------------------|---|-------------------|-------------------|--|----------|-----------|-----|-----|----|-----|-----|----|-----|-----|----|-----|-----|----|-----|-----|-----|-----|-----|-----|-----|-----|-----|-----|-----|-----|-----|-----|-----|
| <p>1. Graph</p> <p>Legend: □ Load 50%, △ Load 100%</p> <p>This duration covers from Shut-off of input voltage to the moment when output voltage descends to the rated range of voltage accuracy.</p> <p>Note: Slanted line shows the range of the rated input voltage.</p> <p>出力保持時間とは、入力電圧断から出力電圧が、定電圧精度の規格範囲を保持しているところまでの時間。</p> <p>(注)斜線は定格入力電圧範囲を示す。</p> | | <p>2. Values</p> <table border="1"> <thead> <tr> <th rowspan="2">Input Voltage [V]</th> <th colspan="2">Hold-Up Time [mS]</th> </tr> <tr> <th>Load 50%</th> <th>Load 100%</th> </tr> </thead> <tbody> <tr><td>150</td><td>111</td><td>63</td></tr> <tr><td>160</td><td>127</td><td>73</td></tr> <tr><td>170</td><td>144</td><td>84</td></tr> <tr><td>180</td><td>162</td><td>96</td></tr> <tr><td>200</td><td>201</td><td>121</td></tr> <tr><td>220</td><td>242</td><td>148</td></tr> <tr><td>240</td><td>287</td><td>179</td></tr> <tr><td>264</td><td>345</td><td>218</td></tr> <tr><td>280</td><td>386</td><td>246</td></tr> </tbody> </table> | Input Voltage [V] | Hold-Up Time [mS] | | Load 50% | Load 100% | 150 | 111 | 63 | 160 | 127 | 73 | 170 | 144 | 84 | 180 | 162 | 96 | 200 | 201 | 121 | 220 | 242 | 148 | 240 | 287 | 179 | 264 | 345 | 218 | 280 | 386 | 246 |
| Input Voltage [V] | Hold-Up Time [mS] | | | | | | | | | | | | | | | | | | | | | | | | | | | | | | | | | |
| | Load 50% | Load 100% | | | | | | | | | | | | | | | | | | | | | | | | | | | | | | | | |
| 150 | 111 | 63 | | | | | | | | | | | | | | | | | | | | | | | | | | | | | | | | |
| 160 | 127 | 73 | | | | | | | | | | | | | | | | | | | | | | | | | | | | | | | | |
| 170 | 144 | 84 | | | | | | | | | | | | | | | | | | | | | | | | | | | | | | | | |
| 180 | 162 | 96 | | | | | | | | | | | | | | | | | | | | | | | | | | | | | | | | |
| 200 | 201 | 121 | | | | | | | | | | | | | | | | | | | | | | | | | | | | | | | | |
| 220 | 242 | 148 | | | | | | | | | | | | | | | | | | | | | | | | | | | | | | | | |
| 240 | 287 | 179 | | | | | | | | | | | | | | | | | | | | | | | | | | | | | | | | |
| 264 | 345 | 218 | | | | | | | | | | | | | | | | | | | | | | | | | | | | | | | | |
| 280 | 386 | 246 | | | | | | | | | | | | | | | | | | | | | | | | | | | | | | | | |



| <p>Model LDA10F-5</p> <p>Item Instantaneous Interruption Compensation 瞬時停電保障</p> <p>Object +5.0V2A</p> | | <p>Temperature 25°C</p> <p>Testing Circuitry Figure A</p> | | | | | | | | | | | | | | | | | | | | | | | | | | | | | | | | | | | | | | | | | | | | | | | | | | | |
|---|--------------------|--|--------------------|-----------|--|--|--------------------|--------------------|--------------------|-----|---|---|---|-----|-----|-----|-----|-----|-----|-----|-----|-----|-----|-----|-----|-----|----|-----|-----|-----|----|----|-----|-----|----|----|-----|---|---|---|---|---|---|---|---|---|---|---|---|---|---|---|---|
| <p>1. Graph</p> <p>—△— Input Volt. 170 V - -□- - Input Volt. 200 V - -○- - Input Volt. 264 V</p> <p>Instantaneous Compensation Time [mS]</p> <p>Load Current [A]</p> | | <p>2. Values</p> <table border="1"> <thead> <tr> <th rowspan="2">Load Current [A]</th> <th colspan="3">Time [mS]</th> </tr> <tr> <th>Input Volt. 170[V]</th> <th>Input Volt. 200[V]</th> <th>Input Volt. 264[V]</th> </tr> </thead> <tbody> <tr><td>0.0</td><td>—</td><td>—</td><td>—</td></tr> <tr><td>0.4</td><td>393</td><td>525</td><td>841</td></tr> <tr><td>0.8</td><td>198</td><td>260</td><td>440</td></tr> <tr><td>1.2</td><td>123</td><td>169</td><td>248</td></tr> <tr><td>1.6</td><td>81</td><td>110</td><td>185</td></tr> <tr><td>2.0</td><td>60</td><td>80</td><td>139</td></tr> <tr><td>2.2</td><td>55</td><td>72</td><td>114</td></tr> <tr><td>—</td><td>—</td><td>—</td><td>—</td></tr> <tr><td>—</td><td>—</td><td>—</td><td>—</td></tr> <tr><td>—</td><td>—</td><td>—</td><td>—</td></tr> <tr><td>—</td><td>—</td><td>—</td><td>—</td></tr> </tbody> </table> | Load Current [A] | Time [mS] | | | Input Volt. 170[V] | Input Volt. 200[V] | Input Volt. 264[V] | 0.0 | — | — | — | 0.4 | 393 | 525 | 841 | 0.8 | 198 | 260 | 440 | 1.2 | 123 | 169 | 248 | 1.6 | 81 | 110 | 185 | 2.0 | 60 | 80 | 139 | 2.2 | 55 | 72 | 114 | — | — | — | — | — | — | — | — | — | — | — | — | — | — | — | — |
| Load Current [A] | Time [mS] | | | | | | | | | | | | | | | | | | | | | | | | | | | | | | | | | | | | | | | | | | | | | | | | | | | | |
| | Input Volt. 170[V] | Input Volt. 200[V] | Input Volt. 264[V] | | | | | | | | | | | | | | | | | | | | | | | | | | | | | | | | | | | | | | | | | | | | | | | | | | |
| 0.0 | — | — | — | | | | | | | | | | | | | | | | | | | | | | | | | | | | | | | | | | | | | | | | | | | | | | | | | | |
| 0.4 | 393 | 525 | 841 | | | | | | | | | | | | | | | | | | | | | | | | | | | | | | | | | | | | | | | | | | | | | | | | | | |
| 0.8 | 198 | 260 | 440 | | | | | | | | | | | | | | | | | | | | | | | | | | | | | | | | | | | | | | | | | | | | | | | | | | |
| 1.2 | 123 | 169 | 248 | | | | | | | | | | | | | | | | | | | | | | | | | | | | | | | | | | | | | | | | | | | | | | | | | | |
| 1.6 | 81 | 110 | 185 | | | | | | | | | | | | | | | | | | | | | | | | | | | | | | | | | | | | | | | | | | | | | | | | | | |
| 2.0 | 60 | 80 | 139 | | | | | | | | | | | | | | | | | | | | | | | | | | | | | | | | | | | | | | | | | | | | | | | | | | |
| 2.2 | 55 | 72 | 114 | | | | | | | | | | | | | | | | | | | | | | | | | | | | | | | | | | | | | | | | | | | | | | | | | | |
| — | — | — | — | | | | | | | | | | | | | | | | | | | | | | | | | | | | | | | | | | | | | | | | | | | | | | | | | | |
| — | — | — | — | | | | | | | | | | | | | | | | | | | | | | | | | | | | | | | | | | | | | | | | | | | | | | | | | | |
| — | — | — | — | | | | | | | | | | | | | | | | | | | | | | | | | | | | | | | | | | | | | | | | | | | | | | | | | | |
| — | — | — | — | | | | | | | | | | | | | | | | | | | | | | | | | | | | | | | | | | | | | | | | | | | | | | | | | | |
| <p>This duration covers from Shut-off of input voltage to the moment when output voltage descends to the rated range of voltage accuracy.</p> <p>Note:Slanted line shows the range of the rated load current.</p> <p>瞬時停電保障時間とは、出力電圧が定電圧精度の規格範囲を保持している瞬時停電時間をいう。 (注)斜線は定格負荷電流範囲を示す。</p> | | | | | | | | | | | | | | | | | | | | | | | | | | | | | | | | | | | | | | | | | | | | | | | | | | | | | |



| | |
|--------|------------------------|
| Model | LDA10F-5 |
| Item | Load Regulation 静的負荷変動 |
| Object | +5.0V2A |

Temperature 25°C
Testing Circuitry Figure A

1. Graph

- △— Input Volt. 170 V
- Input Volt. 200 V
- Input Volt. 264 V

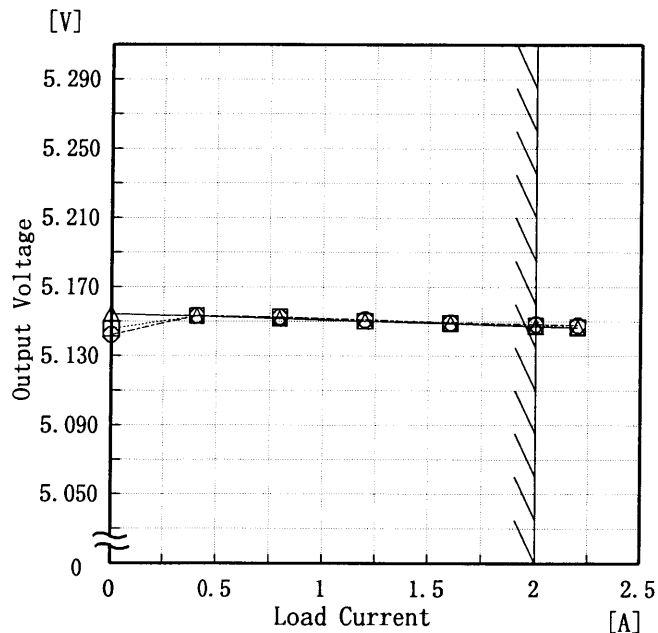

Note: Slanted line shows the range of the rated load current.

(注) 斜線は定格負荷電流範囲を示す。

2. Values

| Load Current [A] | Output Voltage [V] | | |
|---------------------|-----------------------|-----------------------|-----------------------|
| | Input Volt. 170[V] | Input Volt. 200[V] | Input Volt. 264[V] |
| 0.0 | 5.154 | 5.146 | 5.142 |
| 0.4 | 5.153 | 5.153 | 5.153 |
| 0.8 | 5.152 | 5.153 | 5.153 |
| 1.2 | 5.150 | 5.150 | 5.151 |
| 1.6 | 5.149 | 5.149 | 5.150 |
| 2.0 | 5.147 | 5.148 | 5.149 |
| 2.2 | 5.146 | 5.147 | 5.148 |
| — | — | — | — |
| — | — | — | — |
| — | — | — | — |



| <p>Model LDA10F-5</p> <p>Item Ripple Voltage (by Load Current) リップル電圧 (負荷電流特性)</p> <p>Object +5.0V2A</p> | | <p>Temperature 25°C</p> <p>Testing Circuitry Figure A</p> | | | | | | | | | | | | | | | | | | | | | | | | | | | | | | | | | | | | | | |
|---|--------------------------|---|------------------|---------------------|---------------------|--------------------------|--------------------------|------|----|----|------|----|----|------|----|----|------|----|----|------|----|----|------|----|----|------|----|----|---|---|---|---|---|---|---|---|---|---|---|---|
| <p>1. Graph</p> <p>[mV]</p> <p>Input Volt. 170V □</p> <p>Input Volt. 264V △</p> | | <p>2. Values</p> <table border="1"> <thead> <tr> <th rowspan="2">Load Current [A]</th> <th>Input Volt. 170 [V]</th> <th>Input Volt. 264 [V]</th> </tr> <tr> <th>Ripple Output Volt. [mV]</th> <th>Ripple Output Volt. [mV]</th> </tr> </thead> <tbody> <tr><td>0.00</td><td>10</td><td>10</td></tr> <tr><td>0.40</td><td>10</td><td>10</td></tr> <tr><td>0.80</td><td>10</td><td>10</td></tr> <tr><td>1.20</td><td>10</td><td>15</td></tr> <tr><td>1.60</td><td>15</td><td>15</td></tr> <tr><td>2.00</td><td>15</td><td>15</td></tr> <tr><td>2.20</td><td>15</td><td>15</td></tr> <tr><td>—</td><td>—</td><td>—</td></tr> <tr><td>—</td><td>—</td><td>—</td></tr> <tr><td>—</td><td>—</td><td>—</td></tr> <tr><td>—</td><td>—</td><td>—</td></tr> </tbody> </table> | Load Current [A] | Input Volt. 170 [V] | Input Volt. 264 [V] | Ripple Output Volt. [mV] | Ripple Output Volt. [mV] | 0.00 | 10 | 10 | 0.40 | 10 | 10 | 0.80 | 10 | 10 | 1.20 | 10 | 15 | 1.60 | 15 | 15 | 2.00 | 15 | 15 | 2.20 | 15 | 15 | — | — | — | — | — | — | — | — | — | — | — | — |
| Load Current [A] | Input Volt. 170 [V] | Input Volt. 264 [V] | | | | | | | | | | | | | | | | | | | | | | | | | | | | | | | | | | | | | | |
| | Ripple Output Volt. [mV] | Ripple Output Volt. [mV] | | | | | | | | | | | | | | | | | | | | | | | | | | | | | | | | | | | | | | |
| 0.00 | 10 | 10 | | | | | | | | | | | | | | | | | | | | | | | | | | | | | | | | | | | | | | |
| 0.40 | 10 | 10 | | | | | | | | | | | | | | | | | | | | | | | | | | | | | | | | | | | | | | |
| 0.80 | 10 | 10 | | | | | | | | | | | | | | | | | | | | | | | | | | | | | | | | | | | | | | |
| 1.20 | 10 | 15 | | | | | | | | | | | | | | | | | | | | | | | | | | | | | | | | | | | | | | |
| 1.60 | 15 | 15 | | | | | | | | | | | | | | | | | | | | | | | | | | | | | | | | | | | | | | |
| 2.00 | 15 | 15 | | | | | | | | | | | | | | | | | | | | | | | | | | | | | | | | | | | | | | |
| 2.20 | 15 | 15 | | | | | | | | | | | | | | | | | | | | | | | | | | | | | | | | | | | | | | |
| — | — | — | | | | | | | | | | | | | | | | | | | | | | | | | | | | | | | | | | | | | | |
| — | — | — | | | | | | | | | | | | | | | | | | | | | | | | | | | | | | | | | | | | | | |
| — | — | — | | | | | | | | | | | | | | | | | | | | | | | | | | | | | | | | | | | | | | |
| — | — | — | | | | | | | | | | | | | | | | | | | | | | | | | | | | | | | | | | | | | | |
| <p>Ripple Voltage is shown as p-p in the figure below.</p> <p>Note: Slanted line shows the range of the rated load current.</p> <p>リップル電圧は、下図 p-p 値で示される。</p> <p>(注) 斜線は定格負荷電流範囲を示す。</p> <p>T1: Due to AC Input Line 入力商用周期</p> <p>T2: Due to Switching スイッチング周期</p> <p>Fig. Complex Ripple Wave Form 図 リップル波形詳細図</p> | | | | | | | | | | | | | | | | | | | | | | | | | | | | | | | | | | | | | | | | |



| Model | | LDA10F-5 | | Temperature | | 25°C | | | | | | | | | | | | | | | | | | | | | | | | | | | | | | | | | | | | | | | |
|---|------------------------|------------------------|--|---|--|----------|--|---------------------|------------------------|------------------------|----------------------|----------------------|------|----|----|------|----|----|------|----|----|------|----|----|------|----|----|------|----|----|------|----|----|---|---|---|---|---|---|---|---|---|---|---|---|
| Item | | Ripple-Noise リップルノイズ | | Testing Circuitry | | Figure A | | | | | | | | | | | | | | | | | | | | | | | | | | | | | | | | | | | | | | | |
| Object | | +5.0V2A | | | | | | | | | | | | | | | | | | | | | | | | | | | | | | | | | | | | | | | | | | | |
| <p>1. Graph</p> <p>[mV]</p> <p>□ Input Volt. 170V</p> <p>△ Input Volt. 264V</p> | | | | <p>2. Values</p> <table border="1"> <thead> <tr> <th rowspan="2">Load current [A]</th> <th>Input Volt. 170 [V]</th> <th>Input Volt. 264 [V]</th> </tr> <tr> <th>Ripple-Noise [mV]</th> <th>Ripple-Noise [mV]</th> </tr> </thead> <tbody> <tr><td>0.00</td><td>15</td><td>15</td></tr> <tr><td>0.40</td><td>15</td><td>20</td></tr> <tr><td>0.80</td><td>15</td><td>20</td></tr> <tr><td>1.20</td><td>25</td><td>30</td></tr> <tr><td>1.60</td><td>30</td><td>30</td></tr> <tr><td>2.00</td><td>40</td><td>30</td></tr> <tr><td>2.20</td><td>40</td><td>30</td></tr> <tr><td>—</td><td>—</td><td>—</td></tr> <tr><td>—</td><td>—</td><td>—</td></tr> <tr><td>—</td><td>—</td><td>—</td></tr> <tr><td>—</td><td>—</td><td>—</td></tr> </tbody> </table> | | | | Load current [A] | Input Volt. 170 [V] | Input Volt. 264 [V] | Ripple-Noise [mV] | Ripple-Noise [mV] | 0.00 | 15 | 15 | 0.40 | 15 | 20 | 0.80 | 15 | 20 | 1.20 | 25 | 30 | 1.60 | 30 | 30 | 2.00 | 40 | 30 | 2.20 | 40 | 30 | — | — | — | — | — | — | — | — | — | — | — | — |
| Load current [A] | Input Volt. 170 [V] | Input Volt. 264 [V] | | | | | | | | | | | | | | | | | | | | | | | | | | | | | | | | | | | | | | | | | | | |
| | Ripple-Noise [mV] | Ripple-Noise [mV] | | | | | | | | | | | | | | | | | | | | | | | | | | | | | | | | | | | | | | | | | | | |
| 0.00 | 15 | 15 | | | | | | | | | | | | | | | | | | | | | | | | | | | | | | | | | | | | | | | | | | | |
| 0.40 | 15 | 20 | | | | | | | | | | | | | | | | | | | | | | | | | | | | | | | | | | | | | | | | | | | |
| 0.80 | 15 | 20 | | | | | | | | | | | | | | | | | | | | | | | | | | | | | | | | | | | | | | | | | | | |
| 1.20 | 25 | 30 | | | | | | | | | | | | | | | | | | | | | | | | | | | | | | | | | | | | | | | | | | | |
| 1.60 | 30 | 30 | | | | | | | | | | | | | | | | | | | | | | | | | | | | | | | | | | | | | | | | | | | |
| 2.00 | 40 | 30 | | | | | | | | | | | | | | | | | | | | | | | | | | | | | | | | | | | | | | | | | | | |
| 2.20 | 40 | 30 | | | | | | | | | | | | | | | | | | | | | | | | | | | | | | | | | | | | | | | | | | | |
| — | — | — | | | | | | | | | | | | | | | | | | | | | | | | | | | | | | | | | | | | | | | | | | | |
| — | — | — | | | | | | | | | | | | | | | | | | | | | | | | | | | | | | | | | | | | | | | | | | | |
| — | — | — | | | | | | | | | | | | | | | | | | | | | | | | | | | | | | | | | | | | | | | | | | | |
| — | — | — | | | | | | | | | | | | | | | | | | | | | | | | | | | | | | | | | | | | | | | | | | | |
| <p>Ripple-Noise is shown as p-p in the figure below. Note: Slanted line shows the range of the rated load current.</p> <p>リップルノイズは、下図 p-p 値で示される。 (注) 斜線は定格負荷電流範囲を示す。</p> <p>T1: Due to AC Input Line 入力商用周期 T2: Due to Switching スイッチング周期</p> <p>Fig. Complex Ripple Wave Form 図 リップル波形詳細図</p> | | | | | | | | | | | | | | | | | | | | | | | | | | | | | | | | | | | | | | | | | | | | | |



| <p>Model LDA10F-5</p> <p>Item Overcurrent Protection 過電流保護</p> <p>Object +5.0V2A</p> | | <p>Temperature 25°C</p> <p>Testing Circuitry Figure A</p> | | | | | | | | | | | | | | | | | | | | | | | | | | | | | | | | | | | | | | | | | | | | | | | | | | | | | | | |
|---|--------------------|--|--------------------|------------------|--|--|--------------------|--------------------|--------------------|------|------|------|------|------|------|------|------|------|------|------|------|------|------|------|------|------|------|------|------|------|------|------|------|------|------|------|------|------|------|------|------|------|------|------|------|------|------|------|------|------|------|------|------|------|------|------|------|
| <p>1. Graph</p> <p>[V]</p> <p>8.0</p> <p>6.0</p> <p>4.0</p> <p>2.0</p> <p>0.0</p> <p>0 1 2 3 4</p> <p>Output Voltage [V]</p> <p>Load Current [A]</p> <p> Input Volt. 170 V Input Volt. 200 V Input Volt. 264 V </p> | | <p>2. Values</p> <table border="1"> <thead> <tr> <th rowspan="2">Output Voltage [V]</th> <th colspan="3">Load Current [A]</th> </tr> <tr> <th>Input Volt. 170[V]</th> <th>Input Volt. 200[V]</th> <th>Input Volt. 264[V]</th> </tr> </thead> <tbody> <tr><td>5.00</td><td>2.80</td><td>2.84</td><td>2.97</td></tr> <tr><td>4.75</td><td>2.81</td><td>2.85</td><td>2.98</td></tr> <tr><td>4.50</td><td>2.83</td><td>2.86</td><td>2.99</td></tr> <tr><td>4.00</td><td>2.85</td><td>2.88</td><td>2.99</td></tr> <tr><td>3.50</td><td>2.86</td><td>2.88</td><td>2.98</td></tr> <tr><td>3.00</td><td>2.84</td><td>2.86</td><td>2.97</td></tr> <tr><td>2.50</td><td>2.82</td><td>2.83</td><td>2.93</td></tr> <tr><td>2.00</td><td>2.76</td><td>2.77</td><td>2.87</td></tr> <tr><td>1.50</td><td>2.67</td><td>2.69</td><td>2.78</td></tr> <tr><td>1.00</td><td>2.53</td><td>2.55</td><td>2.65</td></tr> <tr><td>0.50</td><td>2.31</td><td>2.32</td><td>2.41</td></tr> <tr><td>0.00</td><td>2.09</td><td>2.10</td><td>2.30</td></tr> </tbody> </table> | Output Voltage [V] | Load Current [A] | | | Input Volt. 170[V] | Input Volt. 200[V] | Input Volt. 264[V] | 5.00 | 2.80 | 2.84 | 2.97 | 4.75 | 2.81 | 2.85 | 2.98 | 4.50 | 2.83 | 2.86 | 2.99 | 4.00 | 2.85 | 2.88 | 2.99 | 3.50 | 2.86 | 2.88 | 2.98 | 3.00 | 2.84 | 2.86 | 2.97 | 2.50 | 2.82 | 2.83 | 2.93 | 2.00 | 2.76 | 2.77 | 2.87 | 1.50 | 2.67 | 2.69 | 2.78 | 1.00 | 2.53 | 2.55 | 2.65 | 0.50 | 2.31 | 2.32 | 2.41 | 0.00 | 2.09 | 2.10 | 2.30 |
| Output Voltage [V] | Load Current [A] | | | | | | | | | | | | | | | | | | | | | | | | | | | | | | | | | | | | | | | | | | | | | | | | | | | | | | | | |
| | Input Volt. 170[V] | Input Volt. 200[V] | Input Volt. 264[V] | | | | | | | | | | | | | | | | | | | | | | | | | | | | | | | | | | | | | | | | | | | | | | | | | | | | | | |
| 5.00 | 2.80 | 2.84 | 2.97 | | | | | | | | | | | | | | | | | | | | | | | | | | | | | | | | | | | | | | | | | | | | | | | | | | | | | | |
| 4.75 | 2.81 | 2.85 | 2.98 | | | | | | | | | | | | | | | | | | | | | | | | | | | | | | | | | | | | | | | | | | | | | | | | | | | | | | |
| 4.50 | 2.83 | 2.86 | 2.99 | | | | | | | | | | | | | | | | | | | | | | | | | | | | | | | | | | | | | | | | | | | | | | | | | | | | | | |
| 4.00 | 2.85 | 2.88 | 2.99 | | | | | | | | | | | | | | | | | | | | | | | | | | | | | | | | | | | | | | | | | | | | | | | | | | | | | | |
| 3.50 | 2.86 | 2.88 | 2.98 | | | | | | | | | | | | | | | | | | | | | | | | | | | | | | | | | | | | | | | | | | | | | | | | | | | | | | |
| 3.00 | 2.84 | 2.86 | 2.97 | | | | | | | | | | | | | | | | | | | | | | | | | | | | | | | | | | | | | | | | | | | | | | | | | | | | | | |
| 2.50 | 2.82 | 2.83 | 2.93 | | | | | | | | | | | | | | | | | | | | | | | | | | | | | | | | | | | | | | | | | | | | | | | | | | | | | | |
| 2.00 | 2.76 | 2.77 | 2.87 | | | | | | | | | | | | | | | | | | | | | | | | | | | | | | | | | | | | | | | | | | | | | | | | | | | | | | |
| 1.50 | 2.67 | 2.69 | 2.78 | | | | | | | | | | | | | | | | | | | | | | | | | | | | | | | | | | | | | | | | | | | | | | | | | | | | | | |
| 1.00 | 2.53 | 2.55 | 2.65 | | | | | | | | | | | | | | | | | | | | | | | | | | | | | | | | | | | | | | | | | | | | | | | | | | | | | | |
| 0.50 | 2.31 | 2.32 | 2.41 | | | | | | | | | | | | | | | | | | | | | | | | | | | | | | | | | | | | | | | | | | | | | | | | | | | | | | |
| 0.00 | 2.09 | 2.10 | 2.30 | | | | | | | | | | | | | | | | | | | | | | | | | | | | | | | | | | | | | | | | | | | | | | | | | | | | | | |
| <p>Note: Slanted line shows the range of the rated load current.</p> <p>(注)斜線は定格負荷電流範囲を示す。</p> | | | | | | | | | | | | | | | | | | | | | | | | | | | | | | | | | | | | | | | | | | | | | | | | | | | | | | | | | |



| | | |
|--------|---------------------|--|
| Model | LDA10F-5 | Temperature 25°C Testing Circuitry Figure A |
| Item | Inrush Current 突入電流 | |
| Object | _____ | |

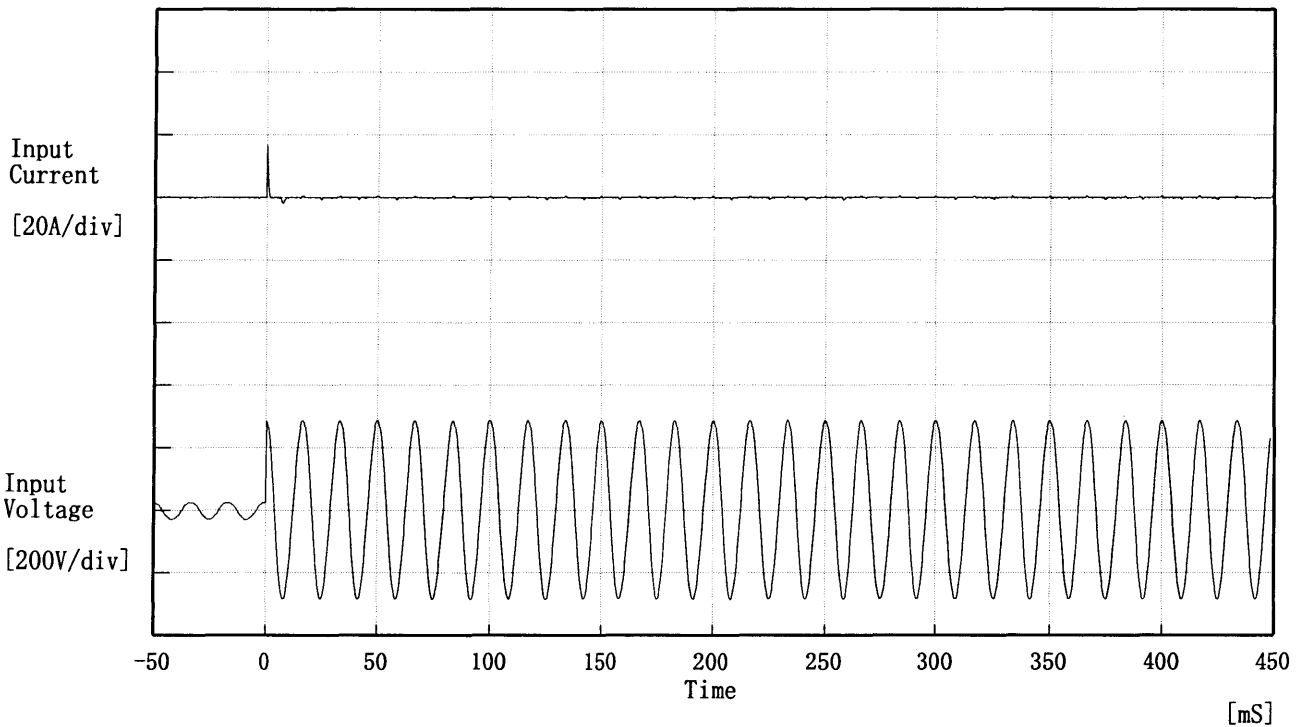

Input Voltage 200 V
 Frequency 60 Hz
 Load 100 %
 Inrush Current
 ① 16.81 [A]
 ② 0.79 [A]

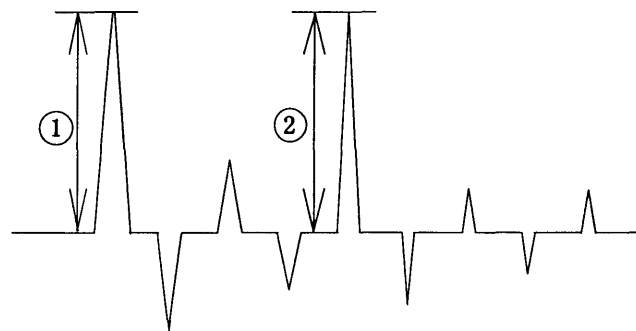

COSEL

| | | | |
|--------|---------------------------------|-------------------|----------|
| Model | LDA10F-5 | Temperature | 25°C |
| Item | Dynamic Load Responce 動的負荷変動 | Testing Circuitry | Figure A |
| Object | +5.0V2A | | |

Input Volt. 200 V

Cycle 1000 mS



Load 0% ←→

Load 100 %

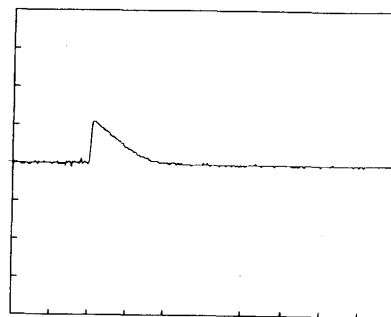
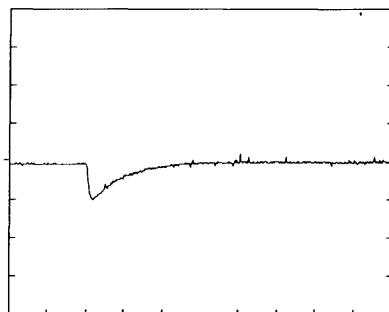

Load 0% ←→

Load 50 %

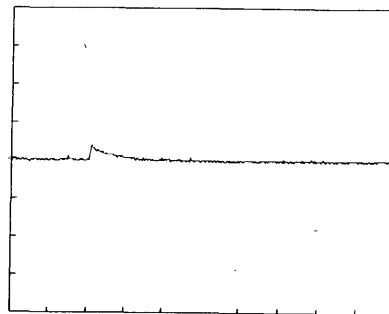
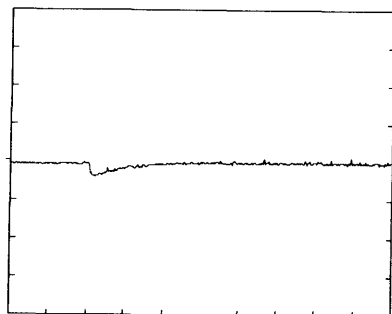

200 mV/div

10 mS/div



| | | | |
|--------|------------------------------|-------------------|----------|
| Model | LDA10F-5 | Temperature | 25°C |
| Item | Rise and Fall Time 立上り、立下り時間 | Testing Circuitry | Figure A |
| Object | +5.0V2A | | |

1. Graph

Input Volt. 170 V

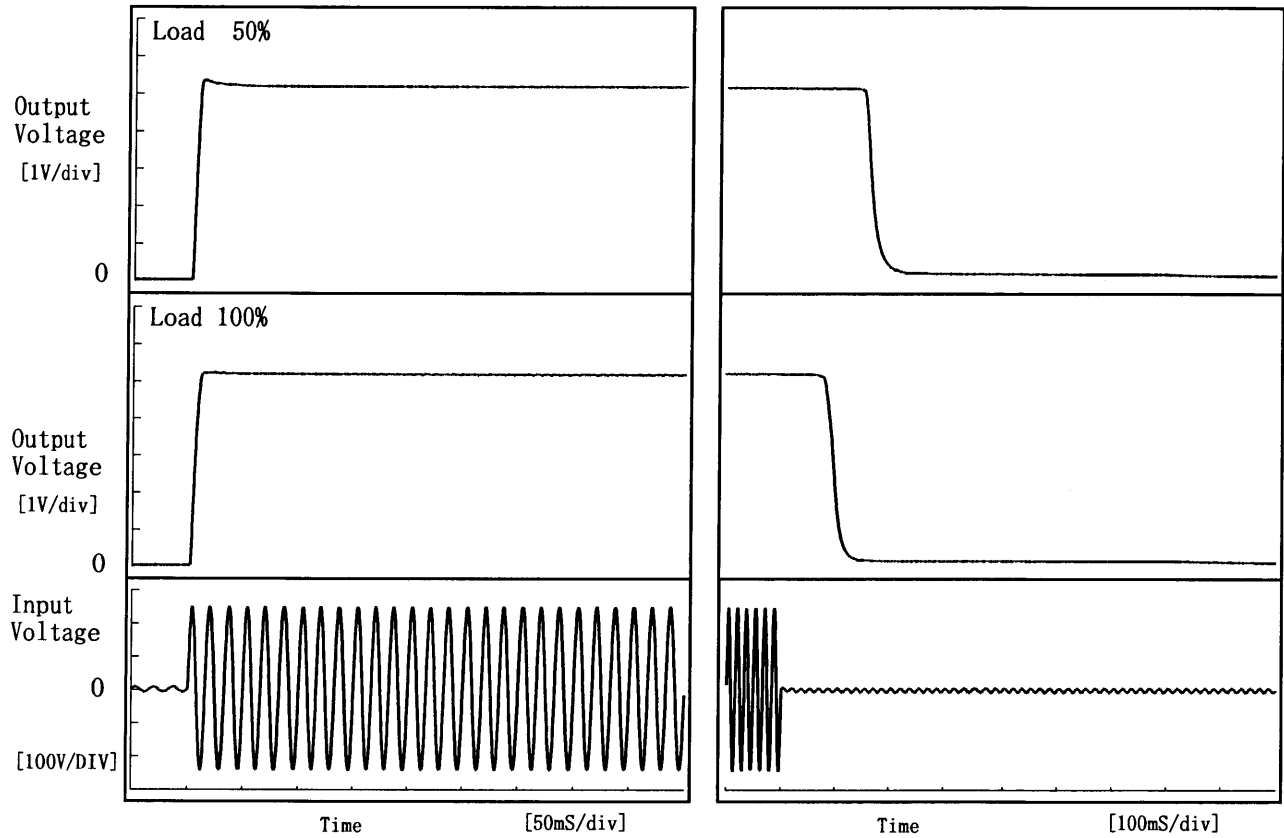

2. Values

[mS]

| Load \ Time | T d | T r | T s | T h | T f |
|-------------|-----|-----|-----|-------|------|
| 50 % | 2.3 | 6.3 | 8.5 | 157.0 | 36.5 |
| 100 % | 2.3 | 7.3 | 9.5 | 87.0 | 30.0 |

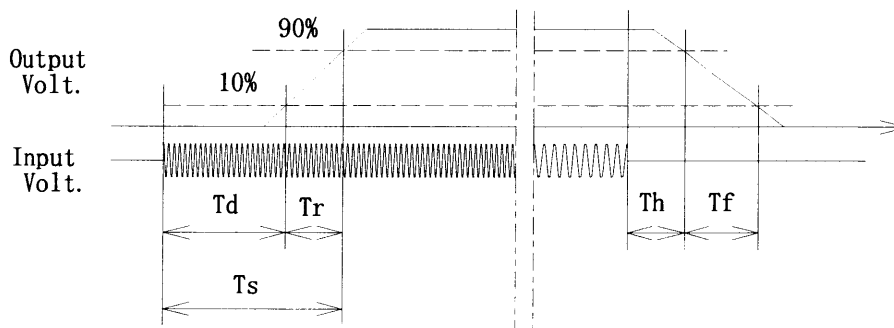



| | |
|--------|-------------------------------------|
| Model | LDA10F-5 |
| Item | Ambient Temperature Drift 周囲温度変動 |
| Object | +5.0V2A |

Testing Circuitry Figure A

1. Graph

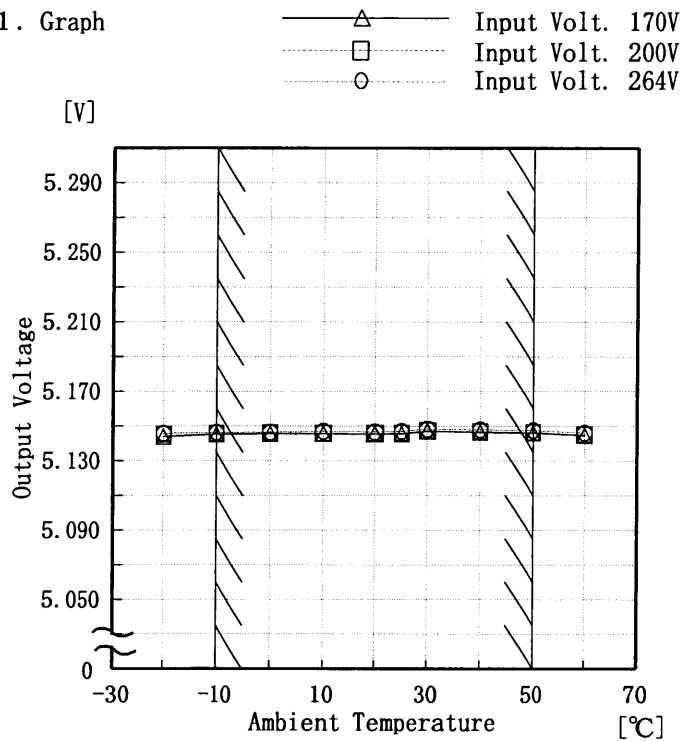

Note: Slanted line shows the range of the rated ambient temperature.

(注)斜線は定格周囲温度範囲を示す。

2. Values

| Temperature [°C] | Output Voltage [V] | | |
|------------------|--------------------|--------------------|--------------------|
| | Input Volt. 170[V] | Input Volt. 200[V] | Input Volt. 264[V] |
| -20 | 5.144 | 5.145 | 5.146 |
| -10 | 5.145 | 5.146 | 5.146 |
| 0 | 5.145 | 5.146 | 5.147 |
| 10 | 5.145 | 5.146 | 5.147 |
| 20 | 5.145 | 5.146 | 5.147 |
| 25 | 5.146 | 5.146 | 5.147 |
| 30 | 5.147 | 5.147 | 5.148 |
| 40 | 5.147 | 5.147 | 5.148 |
| 50 | 5.146 | 5.147 | 5.148 |
| 60 | 5.145 | 5.145 | 5.146 |
| - | - | - | - |



| Model | | LDA10F-5 | Testing Circuitry Figure A | | | | | | | | | | | | | | | | | | | | | | | | | | | | | | | | | | | | | | |
|--|-------------------|--|----------------------------|-------------------|--|----------|-----------|-----|----|----|-----|----|----|---|----|----|----|----|----|----|----|----|----|----|----|----|----|----|----|----|----|----|----|----|----|----|----|---|---|---|--|
| Item | | Minimum Input Voltage for Regulated Output Voltage 最低レギュレーション電圧 | | | | | | | | | | | | | | | | | | | | | | | | | | | | | | | | | | | | | | | |
| Object | | +5.0V2A | | | | | | | | | | | | | | | | | | | | | | | | | | | | | | | | | | | | | | | |
| 1. Graph | | <div style="display: flex; justify-content: space-around;"> <div> <p>-----□----- Load 50%</p> <p>-----△----- Load 100%</p> </div> </div> | 2. Values | | | | | | | | | | | | | | | | | | | | | | | | | | | | | | | | | | | | | | |
| | | <table border="1"> <thead> <tr> <th rowspan="2">Ambient Temperature [°C]</th> <th colspan="2">Input Voltage [V]</th> </tr> <tr> <th>Load 50%</th> <th>Load 100%</th> </tr> </thead> <tbody> <tr><td>-20</td><td>42</td><td>67</td></tr> <tr><td>-10</td><td>42</td><td>67</td></tr> <tr><td>0</td><td>41</td><td>68</td></tr> <tr><td>10</td><td>42</td><td>69</td></tr> <tr><td>20</td><td>42</td><td>69</td></tr> <tr><td>25</td><td>42</td><td>70</td></tr> <tr><td>30</td><td>42</td><td>70</td></tr> <tr><td>40</td><td>43</td><td>71</td></tr> <tr><td>50</td><td>43</td><td>72</td></tr> <tr><td>60</td><td>44</td><td>74</td></tr> <tr><td>—</td><td>—</td><td>—</td></tr> </tbody> </table> | Ambient Temperature [°C] | Input Voltage [V] | | Load 50% | Load 100% | -20 | 42 | 67 | -10 | 42 | 67 | 0 | 41 | 68 | 10 | 42 | 69 | 20 | 42 | 69 | 25 | 42 | 70 | 30 | 42 | 70 | 40 | 43 | 71 | 50 | 43 | 72 | 60 | 44 | 74 | — | — | — | |
| Ambient Temperature [°C] | Input Voltage [V] | | | | | | | | | | | | | | | | | | | | | | | | | | | | | | | | | | | | | | | | |
| | Load 50% | Load 100% | | | | | | | | | | | | | | | | | | | | | | | | | | | | | | | | | | | | | | | |
| -20 | 42 | 67 | | | | | | | | | | | | | | | | | | | | | | | | | | | | | | | | | | | | | | | |
| -10 | 42 | 67 | | | | | | | | | | | | | | | | | | | | | | | | | | | | | | | | | | | | | | | |
| 0 | 41 | 68 | | | | | | | | | | | | | | | | | | | | | | | | | | | | | | | | | | | | | | | |
| 10 | 42 | 69 | | | | | | | | | | | | | | | | | | | | | | | | | | | | | | | | | | | | | | | |
| 20 | 42 | 69 | | | | | | | | | | | | | | | | | | | | | | | | | | | | | | | | | | | | | | | |
| 25 | 42 | 70 | | | | | | | | | | | | | | | | | | | | | | | | | | | | | | | | | | | | | | | |
| 30 | 42 | 70 | | | | | | | | | | | | | | | | | | | | | | | | | | | | | | | | | | | | | | | |
| 40 | 43 | 71 | | | | | | | | | | | | | | | | | | | | | | | | | | | | | | | | | | | | | | | |
| 50 | 43 | 72 | | | | | | | | | | | | | | | | | | | | | | | | | | | | | | | | | | | | | | | |
| 60 | 44 | 74 | | | | | | | | | | | | | | | | | | | | | | | | | | | | | | | | | | | | | | | |
| — | — | — | | | | | | | | | | | | | | | | | | | | | | | | | | | | | | | | | | | | | | | |
| Note: Slanted line shows the range of the rated ambient temperature. | | | | | | | | | | | | | | | | | | | | | | | | | | | | | | | | | | | | | | | | | |
| (注)斜線は定格周囲温度範囲を示す。 | | | | | | | | | | | | | | | | | | | | | | | | | | | | | | | | | | | | | | | | | |

COSEL

| Model | | LDA10F-5 | Testing Circuitry Figure A | | | | | | | | | | | | | | | | | | | | | | | | | | | | | | | | | | | | | |
|--------------------|--------------------------------------|--|--|--|--------------------|--------------------------------------|---------------------------------------|-----|----|----|-----|----|----|---|----|----|----|----|----|----|----|----|----|----|----|----|----|----|----|----|----|----|----|----|----|----|----|---|---|---|
| Item | | Ripple Voltage (by Ambient Temp.) リップル電圧 (周囲温度特性) | | | | | | | | | | | | | | | | | | | | | | | | | | | | | | | | | | | | | | |
| Object | | +5.0V2A | 2. Values | | | | | | | | | | | | | | | | | | | | | | | | | | | | | | | | | | | | | |
| 1. Graph | | <div style="display: flex; justify-content: space-around;"> □ --- Load 50% — △ — Load 100% </div> <p style="text-align: center;">Input Volt. 200 V</p> | | | | | | | | | | | | | | | | | | | | | | | | | | | | | | | | | | | | | | |
| | | | <table border="1"> <thead> <tr> <th>Ambient Temp. [°C]</th> <th>Load 50% Ripple Output Volt. [mV]</th> <th>Load 100% Ripple Output Volt. [mV]</th> </tr> </thead> <tbody> <tr><td>-20</td><td>50</td><td>30</td></tr> <tr><td>-10</td><td>30</td><td>20</td></tr> <tr><td>0</td><td>20</td><td>10</td></tr> <tr><td>10</td><td>10</td><td>10</td></tr> <tr><td>20</td><td>10</td><td>10</td></tr> <tr><td>25</td><td>10</td><td>10</td></tr> <tr><td>30</td><td>10</td><td>10</td></tr> <tr><td>40</td><td>10</td><td>10</td></tr> <tr><td>50</td><td>10</td><td>10</td></tr> <tr><td>60</td><td>10</td><td>10</td></tr> <tr><td>—</td><td>—</td><td>—</td></tr> </tbody> </table> | | Ambient Temp. [°C] | Load 50% Ripple Output Volt. [mV] | Load 100% Ripple Output Volt. [mV] | -20 | 50 | 30 | -10 | 30 | 20 | 0 | 20 | 10 | 10 | 10 | 10 | 20 | 10 | 10 | 25 | 10 | 10 | 30 | 10 | 10 | 40 | 10 | 10 | 50 | 10 | 10 | 60 | 10 | 10 | — | — | — |
| Ambient Temp. [°C] | Load 50% Ripple Output Volt. [mV] | Load 100% Ripple Output Volt. [mV] | | | | | | | | | | | | | | | | | | | | | | | | | | | | | | | | | | | | | | |
| -20 | 50 | 30 | | | | | | | | | | | | | | | | | | | | | | | | | | | | | | | | | | | | | | |
| -10 | 30 | 20 | | | | | | | | | | | | | | | | | | | | | | | | | | | | | | | | | | | | | | |
| 0 | 20 | 10 | | | | | | | | | | | | | | | | | | | | | | | | | | | | | | | | | | | | | | |
| 10 | 10 | 10 | | | | | | | | | | | | | | | | | | | | | | | | | | | | | | | | | | | | | | |
| 20 | 10 | 10 | | | | | | | | | | | | | | | | | | | | | | | | | | | | | | | | | | | | | | |
| 25 | 10 | 10 | | | | | | | | | | | | | | | | | | | | | | | | | | | | | | | | | | | | | | |
| 30 | 10 | 10 | | | | | | | | | | | | | | | | | | | | | | | | | | | | | | | | | | | | | | |
| 40 | 10 | 10 | | | | | | | | | | | | | | | | | | | | | | | | | | | | | | | | | | | | | | |
| 50 | 10 | 10 | | | | | | | | | | | | | | | | | | | | | | | | | | | | | | | | | | | | | | |
| 60 | 10 | 10 | | | | | | | | | | | | | | | | | | | | | | | | | | | | | | | | | | | | | | |
| — | — | — | | | | | | | | | | | | | | | | | | | | | | | | | | | | | | | | | | | | | | |
| | | <p>Note: Slanted line shows the range of the rated ambient temperature.</p> <p>(注)斜線は定格周囲温度範囲を示す。</p> | | | | | | | | | | | | | | | | | | | | | | | | | | | | | | | | | | | | | | |



| COSEL | | | | | | | | | | | | | | | | | | | | | | | | |
|---|-------------------------|---|----------------------|--------------------|-----|-------|-----|-------|-----|-------|-----|-------|-----|-------|-----|-------|-----|-------|-----|-------|-----|-------|-----|-------|
| Model | LDA10F-5 | | | | | | | | | | | | | | | | | | | | | | | |
| Item | Time Lapse Drift 経時ドリフト | Temperature 25°C Testing Circuitry Figure A | | | | | | | | | | | | | | | | | | | | | | |
| Object | +5.0V2A | | | | | | | | | | | | | | | | | | | | | | | |
| <p>1. Graph</p> <p style="text-align: center;">Input Volt. 200V Load 100%</p> | | <p>2. Values</p> <table border="1"> <thead> <tr> <th>Time since start [H]</th> <th>Output Voltage [V]</th> </tr> </thead> <tbody> <tr><td>0.0</td><td>5.152</td></tr> <tr><td>0.5</td><td>5.149</td></tr> <tr><td>1.0</td><td>5.150</td></tr> <tr><td>2.0</td><td>5.150</td></tr> <tr><td>3.0</td><td>5.149</td></tr> <tr><td>4.0</td><td>5.150</td></tr> <tr><td>5.0</td><td>5.150</td></tr> <tr><td>6.0</td><td>5.150</td></tr> <tr><td>7.0</td><td>5.150</td></tr> <tr><td>8.0</td><td>5.149</td></tr> </tbody> </table> | Time since start [H] | Output Voltage [V] | 0.0 | 5.152 | 0.5 | 5.149 | 1.0 | 5.150 | 2.0 | 5.150 | 3.0 | 5.149 | 4.0 | 5.150 | 5.0 | 5.150 | 6.0 | 5.150 | 7.0 | 5.150 | 8.0 | 5.149 |
| Time since start [H] | Output Voltage [V] | | | | | | | | | | | | | | | | | | | | | | | |
| 0.0 | 5.152 | | | | | | | | | | | | | | | | | | | | | | | |
| 0.5 | 5.149 | | | | | | | | | | | | | | | | | | | | | | | |
| 1.0 | 5.150 | | | | | | | | | | | | | | | | | | | | | | | |
| 2.0 | 5.150 | | | | | | | | | | | | | | | | | | | | | | | |
| 3.0 | 5.149 | | | | | | | | | | | | | | | | | | | | | | | |
| 4.0 | 5.150 | | | | | | | | | | | | | | | | | | | | | | | |
| 5.0 | 5.150 | | | | | | | | | | | | | | | | | | | | | | | |
| 6.0 | 5.150 | | | | | | | | | | | | | | | | | | | | | | | |
| 7.0 | 5.150 | | | | | | | | | | | | | | | | | | | | | | | |
| 8.0 | 5.149 | | | | | | | | | | | | | | | | | | | | | | | |



| | | | |
|--------|--|-------------------------------|----------------------------|
| Model | | LDA10F-5 | Testing Circuitry Figure A |
| Item | | Output Voltage Accuracy 定電圧精度 | |
| Object | | +5.0V2A | |

Output Voltage Accuracy

This is defined as the value of the output voltage, regulation load, ambient temperature and input voltage varied at random in the range as specified below.

Temperature -10~50 °C

Input Voltage : 170~264 V

Load Current : 0~2 A

* Output Voltage Accuracy = $\pm (\text{Maximum of Output Voltage} - \text{Minimum of Output Voltage}) / 2$

* Output Voltage Accuracy (Ration) = $\frac{\text{Output Voltage Accuracy}}{\text{Rated Output Voltage}} \times 100$

定電圧精度

周囲温度、入力電圧、負荷電流を下記仕様内で、任意に変動させたときの出力電圧の変動をいう。

周囲温度 -10~50 °C

入力電圧 170~264 V

負荷電流 0~2 A

* 定電圧精度(変動値) = $\pm (\text{出力電圧の最高値} - \text{出力電圧の最低値}) / 2$

* 定電圧精度(変動率) = $\frac{\text{変動値}}{\text{定格出力電圧}} \times 100$

| Item | Temperature [°C] | Input Voltage [V] | Output Current [A] | Output Voltage [V] | Output Voltage Accuracy [mV] | Output Voltage Accuracy(Ration) [%] |
|-----------------|------------------|-------------------|--------------------|--------------------|------------------------------|-------------------------------------|
| Maximum Voltage | 50 | 170 | 0 | 5.154 | ±8 | ±0.2 |
| Minimum Voltage | -10 | 264 | 0 | 5.140 | | |

COSEL

| | | |
|--------------|-------------------|----------------------------|
| COSEL | | |
| Model | LDA10F-5 | |
| Item | Condensation 結露特性 | Testing Circuitry Figure A |
| Object | +5.0V2A | |

1. Condensation test

Testing procedure is as follows.

- ① Keeping and cooling the unit in a tank at -10°C for an hour with the input off.
- ② Taking it out of the tank and dewing itself in a room where the temperature is 25°C and the humidity is 40%RH.
- ③ Testing electrical characteristics of the unit to confirm there be no fault.

1. 結露特性試験

入力を切った状態で、恒温槽で -10°C に冷却しておき、約1時間後に恒温槽から取り出し、室温 25°C 、湿度40%RHの状態におき結露させ、その電気的特性の測定を行い、異常のないことを確認する。

2. Values

| Item | Data | Testing Conditions |
|----------------------|------|--|
| Output Voltage [V] | 5.14 | Input Volt.: 200V, Load Current:2A |
| Line Regulation [mV] | 5 | Input Volt.: 170~264V, Load Current:2A |
| Load Regulation [mV] | 12 | Input Volt.: 200V, Load Current:0~2A |



| | | | | |
|--------|--|----------------------|-------------------|----------|
| Model | | LDA10F-5 | Temperature | 25°C |
| Item | | Leakage Current 漏洩電流 | Testing Circuitry | Figure B |
| Object | | _____ | | |

1. Results

| Standards | Leakage Current [mA] | | |
|--------------|-----------------------|------------------------|------------------------|
| | Input Volt. 85 [V] | Input Volt. 100 [V] | Input Volt. 132 [V] |
| (A) DENTORI | --- | --- | --- |
| (B) IEC60950 | --- | --- | --- |

| Standards | Leakage Current [mA] | | |
|--------------|------------------------|------------------------|------------------------|
| | Input Volt. 170 [V] | Input Volt. 230 [V] | Input Volt. 264 [V] |
| (B) IEC60950 | 0.23 | 0.26 | 0.28 |

2. Condition

Leakage current value is concluded after measuring both phases of AC input and by choosing the larger one.

交流入力の両相について測定し、その大きい方を漏洩電流測定値とする。

COSEL

| | | |
|--------|--------------------------------|--|
| Model | LDA10F-5 | Temperature 25°C Testing Circuitry Figure C |
| Item | Line Noise Tolerance 入力雑音耐量 | |
| Object | +5.0V2A | |

1. Results

| Pulse Width [nS] | MODE | No protection failure should occur 保護回路の誤動作がない | DC-like Regulation of Output Voltage 出力電圧の直流的変動 |
|-----------------------|--------|---|--|
| 50 | COMMON | OK | no fluctuation |
| | NORMAL | OK | no fluctuation |
| 1000 | COMMON | OK | no fluctuation |
| | NORMAL | OK | no fluctuation |

2. Conditions

Input Voltage : 200 V
 Pulse Voltage : 2000 V
 Pulse Cycle : 10 mS
 Pulse Input Duration : 1 min. or more
 Load : 100 %



| | | | |
|--------|------------------------------|-------------------|----------|
| Model | LDA10F-5 | Temperature | 25°C |
| Item | Conducted Emission 雑音端子電圧 | Testing Circuitry | Figure D |
| Object | _____ | | |

1. Graph

Remarks

Input Volt. 230 V

Load 100 %

規格 1 : [EN 55022] Class B(平均值)

規格 2 : [EN 55022] Class B(QP)

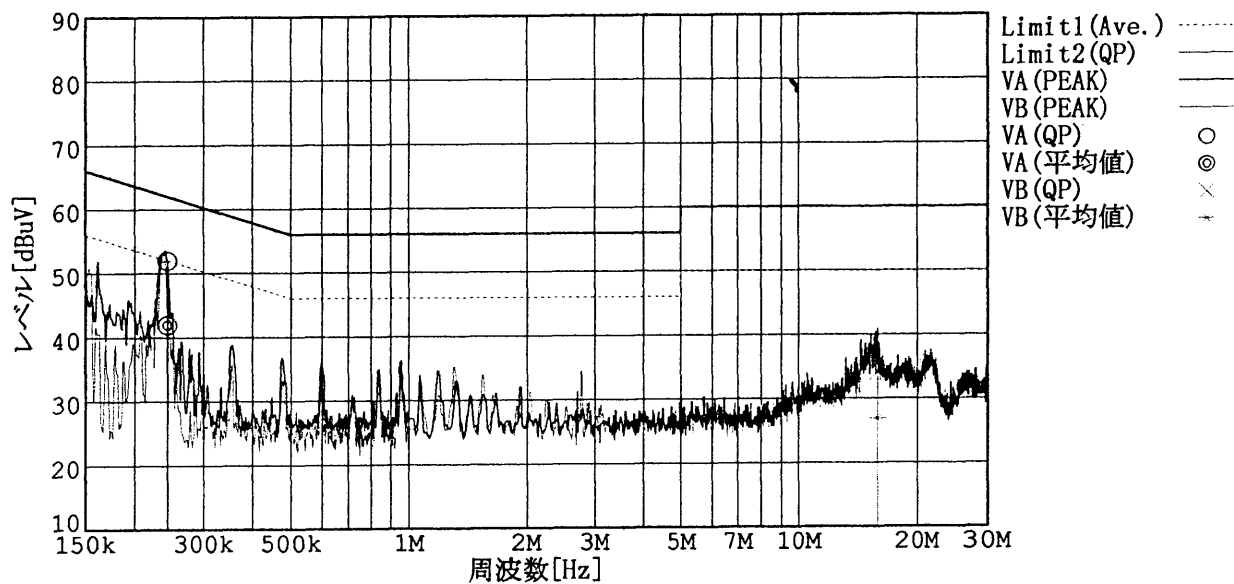

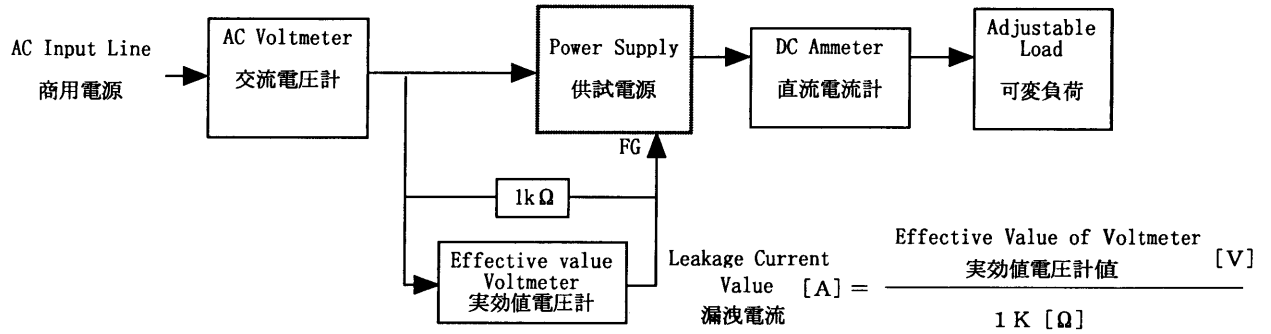
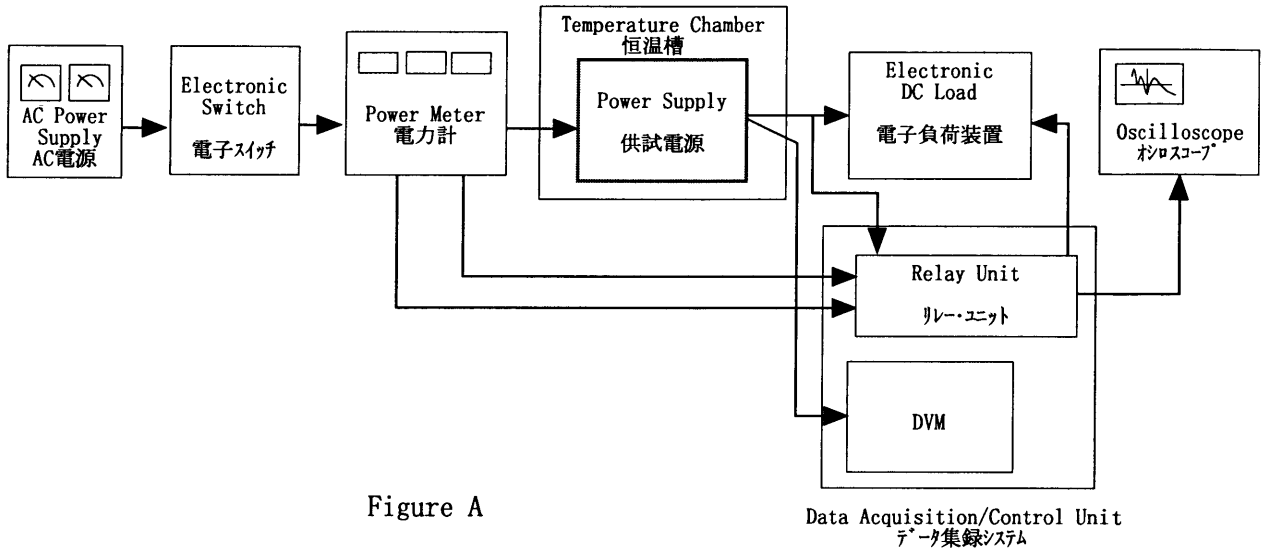

Figure B (DENTORI)

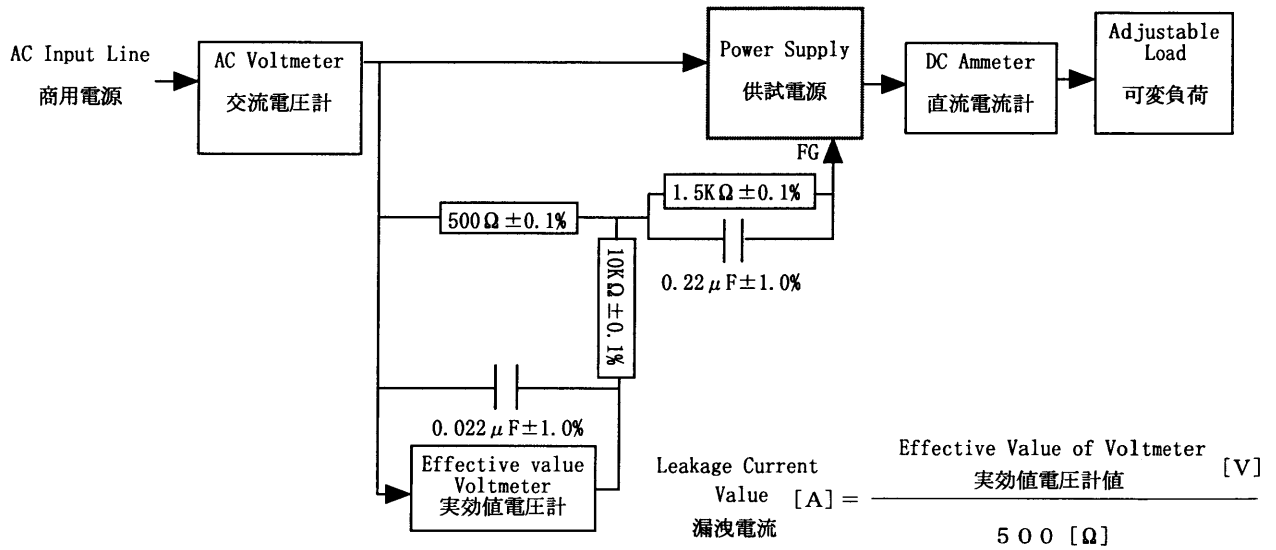

Figure B (IEC 60950)

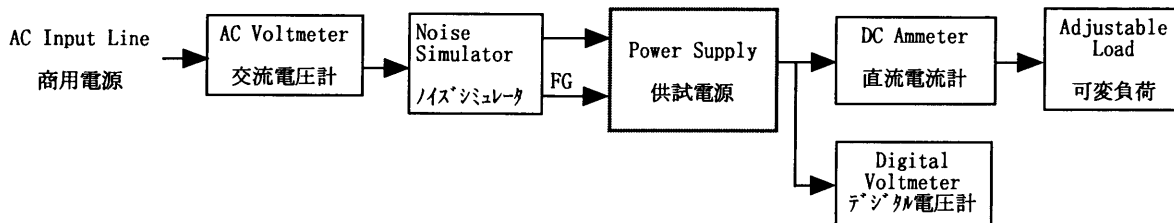

Figure C

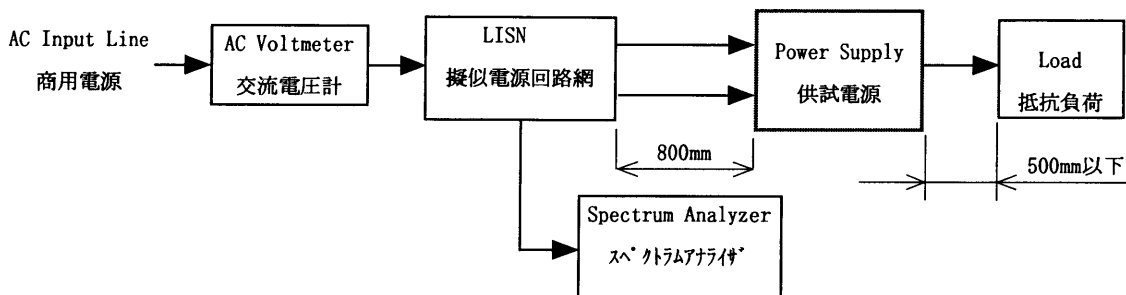

Figure D

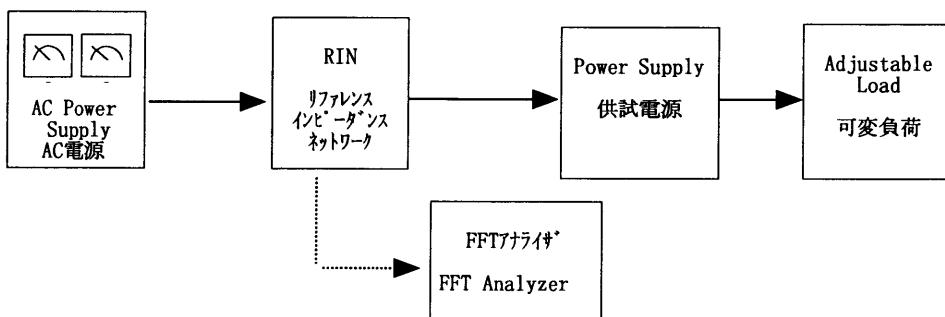

Figure E