



TEST DATA OF LDA10F-24  
(200V INPUT)

Regulated DC Power Supply

June 18, 1999

Approved by : H. Yamaguchi  
Design Manager

Prepared by : T. Ashihara  
Design Engineer

コーセル株式会社

COSEL CO., LTD.

CONTENTS

1. Line Regulation . . . . .	1
静的入力変動	
2. Input Current (by Load Current) . . . . .	2
入力電流 (負荷特性)	
3. Input Power (by Load Current) . . . . .	3
入力電力 (負荷特性)	
4. Efficiency (by Input Voltage) . . . . .	4
効率 (入力電圧特性)	
5. Efficiency (by Load Current) . . . . .	5
効率 (負荷特性)	
6. Hold-Up Time . . . . .	6
出力保持時間	
7. Instantaneous Interruption Compensation . . . . .	7
瞬時停電保障	
8. Load Regulation . . . . .	8
静的負荷変動	
9. Ripple Voltage (by Load Current) . . . . .	9
リップル電圧 (負荷特性)	
10. Ripple-Noise . . . . .	10
リップルノイズ	
11. Overcurrent Protection . . . . .	11
過電流保護	
12. Inrush Current . . . . .	12
突入電流	
13. Dynamic Load Responce . . . . .	13
動的負荷変動	
14. Rise and Fall Time . . . . .	14
立上り、立下がり時間	
15. Ambient Temperature Drift . . . . .	15
周囲温度変動	
16. Minimum Input Voltage for Regulated Output Voltage .	16
最低レギュレーション電圧	
17. Ripple Voltage (by Ambient Temperature) . . . . .	17
リップル電圧 (周囲温度特性)	
18. Time Lapse Drift . . . . .	18
経時ドリフト	
19. Output Voltage Accuracy . . . . .	19
定電圧精度	
20. Condensation . . . . .	20
結露特性	
21. Leakage Current . . . . .	21
漏洩電流	
22. Line Noise Tolerance . . . . .	22
入力雑音耐量	
23. Conducted Emission . . . . .	23
雑音端子電圧	
24. Figure of Testing Circuitry . . . . .	24
測定回路図	

(Final Page 25 )



Model	LDA10F-24
Item	Line Regulation 静的入力変動
Object	+24.0V0.5A

Temperature 25°C  
Testing Circuitry Figure A

1. Graph

□ Load 50%  
△ Load 100%

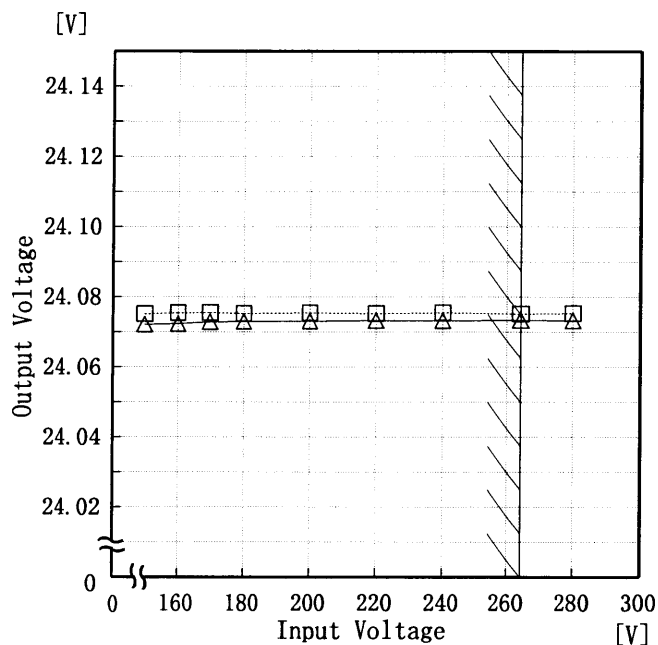

Note: Slanted line shows the range of the rated input voltage.

(注) 斜線は定格入力電圧範囲を示す。

2. Values

Input Voltage [V]	Output Voltage [V]	
	Load 50%	Load 100%
150	24.075	24.072
160	24.075	24.072
170	24.076	24.073
180	24.075	24.073
200	24.075	24.073
220	24.075	24.073
240	24.076	24.073
264	24.075	24.073
280	24.075	24.073



Model	LDA10F-24
Item	Input Current (by Load Current) 入力電流 (負荷特性)
Output	—————

Temperature 25°C  
Testing Circuitry Figure A

1. Graph

—△— Input Volt. 170V  
 - - -□- - - Input Volt. 200V  
 - - -○- - - Input Volt. 264V

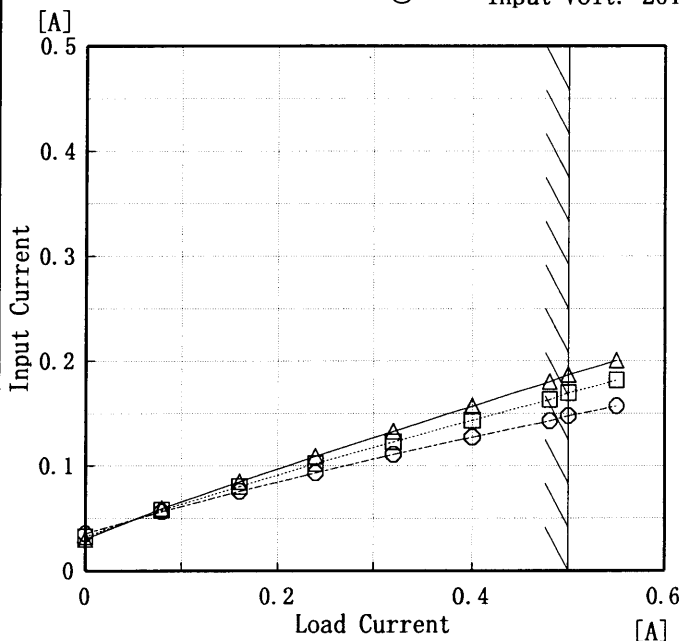

Note: Slanted line shows the range of the rated load current

(注) 斜線は定格負荷電流範囲を示す。

2. Values

Load Current [A]	Input Current [A]		
	Input Volt. 170[V]	Input Volt. 200[V]	Input Volt. 264[V]
0.00	0.030	0.032	0.036
0.08	0.060	0.058	0.056
0.16	0.085	0.080	0.076
0.24	0.109	0.102	0.094
0.32	0.133	0.123	0.111
0.40	0.157	0.144	0.128
0.48	0.181	0.163	0.143
0.50	0.187	0.170	0.148
0.55	0.201	0.182	0.157
—	—	—	—
—	—	—	—
—	—	—	—



Model	LDA10F-24
Item	Input Power (by Load Current) 入力電力 (負荷特性)
Output	—————

Temperature 25°C  
Testing Circuitry Figure A

1. Graph

Input Volt. 170V  

 Input Volt. 200V  

 Input Volt. 264V

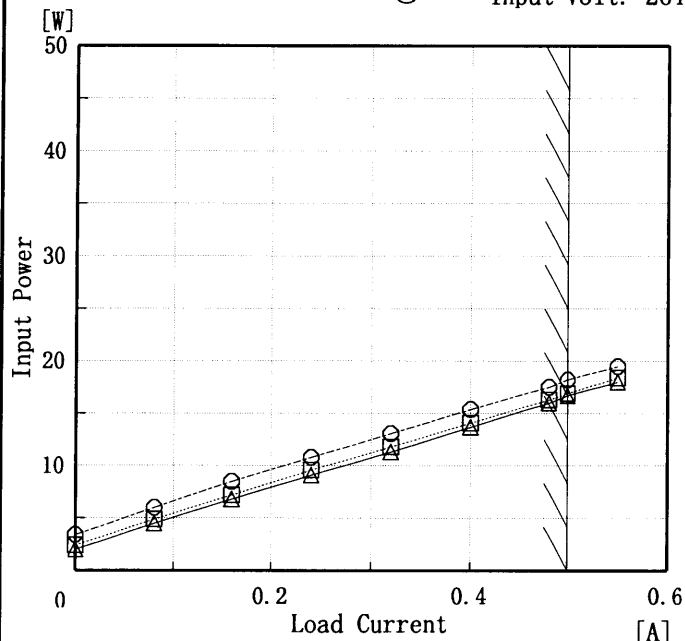

2. Values

Load Current [A]	Input Power [W]		
	Input Volt. 170[V]	Input Volt. 200[V]	Input Volt. 264[V]
0.00	2.00	2.40	3.40
0.08	4.50	4.90	6.00
0.16	6.80	7.20	8.50
0.24	9.10	9.60	10.80
0.32	11.30	11.80	13.10
0.40	13.70	14.10	15.40
0.48	16.00	16.30	17.50
0.50	16.70	16.90	18.20
0.55	18.00	18.40	19.50
—	—	—	—
—	—	—	—
—	—	—	—

Note: Slanted line shows the range of the rated load current

(注) 斜線は定格負荷電流範囲を示す。



Model		LDA10F-24		Temperature		25°C																																	
Item		Efficiency 効率		Testing Circuitry		Figure A																																	
Object																																							
<p>1. Graph</p> <p>□ Load 50%</p> <p>—△— Load 100%</p> <p>Efficiency [%]</p> <p>Input Voltage [V]</p> <p>Note: Slanted line shows the range of the rated input voltage.</p> <p>(注)斜線は定格入力電圧範囲を示す。</p>				<p>2. Values</p> <table border="1"> <thead> <tr> <th rowspan="2">Input Voltage [V]</th> <th colspan="2">Efficiency [%]</th> </tr> <tr> <th>Load 50%</th> <th>Load 100%</th> </tr> </thead> <tbody> <tr><td>150</td><td>71.1</td><td>77.3</td></tr> <tr><td>160</td><td>69.0</td><td>76.7</td></tr> <tr><td>170</td><td>68.0</td><td>76.0</td></tr> <tr><td>180</td><td>67.1</td><td>75.3</td></tr> <tr><td>200</td><td>64.2</td><td>74.3</td></tr> <tr><td>220</td><td>62.0</td><td>72.8</td></tr> <tr><td>240</td><td>59.3</td><td>71.1</td></tr> <tr><td>264</td><td>57.0</td><td>69.3</td></tr> <tr><td>280</td><td>55.2</td><td>67.8</td></tr> </tbody> </table>				Input Voltage [V]	Efficiency [%]		Load 50%	Load 100%	150	71.1	77.3	160	69.0	76.7	170	68.0	76.0	180	67.1	75.3	200	64.2	74.3	220	62.0	72.8	240	59.3	71.1	264	57.0	69.3	280	55.2	67.8
Input Voltage [V]	Efficiency [%]																																						
	Load 50%	Load 100%																																					
150	71.1	77.3																																					
160	69.0	76.7																																					
170	68.0	76.0																																					
180	67.1	75.3																																					
200	64.2	74.3																																					
220	62.0	72.8																																					
240	59.3	71.1																																					
264	57.0	69.3																																					
280	55.2	67.8																																					



Model	LDA10F-24
Item	Efficiency (by Load Current) 効率 (負荷電流特性)
Output	—————

Temperature 25°C  
Testing Circuitry Figure A

1. Graph

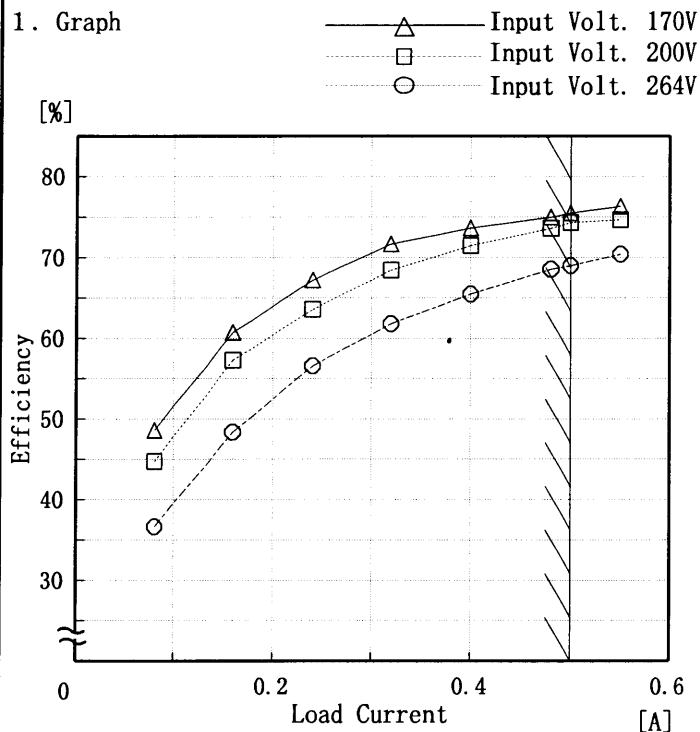

2. Values

Load Current [A]	Efficiency [%]		
	Input Volt. 170[V]	Input Volt. 200[V]	Input Volt. 264[V]
0.08	48.6	44.8	36.7
0.16	60.7	57.3	48.4
0.24	67.2	63.6	56.6
0.32	71.7	68.4	61.8
0.40	73.6	71.5	65.5
0.48	75.0	73.6	68.6
0.50	75.5	74.3	69.0
0.55	76.4	74.7	70.4
—	—	—	—
—	—	—	—
—	—	—	—
—	—	—	—

Note: Slanted line shows the range of the rated load current

(注) 斜線は定格負荷電流範囲を示す。



Model		LDA10F-24		Temperature	25°C																																
Item		Hold-Up Time 出力保持時間		Testing Circuitry	Figure A																																
Object		+24.0V0.5A																																			
1. Graph			□ Load 50% △ Load 100%	2. Values																																	
			<table border="1"> <thead> <tr> <th rowspan="2">Input Voltage [V]</th> <th colspan="2">Hold-Up Time [mS]</th> </tr> <tr> <th>Load 50%</th> <th>Load 100%</th> </tr> </thead> <tbody> <tr><td>150</td><td>126</td><td>60</td></tr> <tr><td>160</td><td>143</td><td>69</td></tr> <tr><td>170</td><td>162</td><td>79</td></tr> <tr><td>180</td><td>181</td><td>89</td></tr> <tr><td>200</td><td>222</td><td>112</td></tr> <tr><td>220</td><td>266</td><td>138</td></tr> <tr><td>240</td><td>314</td><td>165</td></tr> <tr><td>264</td><td>376</td><td>201</td></tr> <tr><td>280</td><td>419</td><td>226</td></tr> </tbody> </table>			Input Voltage [V]	Hold-Up Time [mS]		Load 50%	Load 100%	150	126	60	160	143	69	170	162	79	180	181	89	200	222	112	220	266	138	240	314	165	264	376	201	280	419	226
Input Voltage [V]	Hold-Up Time [mS]																																				
	Load 50%	Load 100%																																			
150	126	60																																			
160	143	69																																			
170	162	79																																			
180	181	89																																			
200	222	112																																			
220	266	138																																			
240	314	165																																			
264	376	201																																			
280	419	226																																			
<p>This duration covers from Shut-off of input voltage to the moment when output voltage descends to the rated range of voltage accuracy.</p> <p>Note: Slanted line shows the range of the rated input voltage.</p> <p>出力保持時間とは、入力電圧断から出力電圧が、定電圧精度の規格範囲を保持しているところまでの時間。</p> <p>(注)斜線は定格入力電圧範囲を示す。</p>																																					





<p>Model LDA10F-24</p> <p>Item Instantaneous Interruption Compensation 瞬時停電保障</p> <p>Object +24.0V0.5A</p>		<p>Temperature 25°C</p> <p>Testing Circuitry Figure A</p>																																																			
<p>1. Graph</p> <p>—△— Input Volt. 170 V - - -□- - - Input Volt. 200 V - - -○- - - Input Volt. 264 V</p> <p>This duration covers from Shut-off of input voltage to the moment when output voltage descends to the rated range of voltage accuracy. Note: Slanted line shows the range of the rated load current.</p> <p>瞬時停電保障時間とは、出力電圧が定電圧精度の規格範囲を保持している瞬時停電時間をいう。 (注)斜線は定格負荷電流範囲を示す。</p>		<p>2. Values</p> <table border="1"> <thead> <tr> <th rowspan="2">Load Current [A]</th> <th colspan="3">Time [mS]</th> </tr> <tr> <th>Input Volt. 170[V]</th> <th>Input Volt. 200[V]</th> <th>Input Volt. 264[V]</th> </tr> </thead> <tbody> <tr><td>0.00</td><td>—</td><td>—</td><td>—</td></tr> <tr><td>0.08</td><td>399</td><td>533</td><td>855</td></tr> <tr><td>0.16</td><td>230</td><td>314</td><td>524</td></tr> <tr><td>0.24</td><td>157</td><td>218</td><td>374</td></tr> <tr><td>0.32</td><td>120</td><td>170</td><td>292</td></tr> <tr><td>0.40</td><td>98</td><td>140</td><td>248</td></tr> <tr><td>0.48</td><td>81</td><td>115</td><td>211</td></tr> <tr><td>0.50</td><td>81</td><td>115</td><td>211</td></tr> <tr><td>0.55</td><td>65</td><td>95</td><td>180</td></tr> <tr><td>—</td><td>—</td><td>—</td><td>—</td></tr> <tr><td>—</td><td>—</td><td>—</td><td>—</td></tr> </tbody> </table>	Load Current [A]	Time [mS]			Input Volt. 170[V]	Input Volt. 200[V]	Input Volt. 264[V]	0.00	—	—	—	0.08	399	533	855	0.16	230	314	524	0.24	157	218	374	0.32	120	170	292	0.40	98	140	248	0.48	81	115	211	0.50	81	115	211	0.55	65	95	180	—	—	—	—	—	—	—	—
Load Current [A]	Time [mS]																																																				
	Input Volt. 170[V]	Input Volt. 200[V]	Input Volt. 264[V]																																																		
0.00	—	—	—																																																		
0.08	399	533	855																																																		
0.16	230	314	524																																																		
0.24	157	218	374																																																		
0.32	120	170	292																																																		
0.40	98	140	248																																																		
0.48	81	115	211																																																		
0.50	81	115	211																																																		
0.55	65	95	180																																																		
—	—	—	—																																																		
—	—	—	—																																																		



Model		LDA10F-24		Temperature		25°C																																																
Item		Load Regulation 静的負荷変動		Testing Circuitry		Figure A																																																
Object		+24.0V0.5A																																																				
<p>1. Graph</p> <p> <span style="display: inline-block; width: 1em; border-bottom: 1px solid black; margin-right: 0.5em;"></span> <span style="display: inline-block; width: 0.5em; height: 0.5em; border: 1px solid black; margin-right: 0.5em;"></span> <span style="display: inline-block; width: 0.5em; height: 0.5em; border: 1px solid black; border-radius: 50%; margin-right: 0.5em;"></span> </p> <p> <span style="display: inline-block; width: 1em; border-bottom: 1px solid black; margin-right: 0.5em;"></span> Input Volt. 170 V  <span style="display: inline-block; width: 0.5em; height: 0.5em; border: 1px solid black; margin-right: 0.5em;"></span> Input Volt. 200 V  <span style="display: inline-block; width: 0.5em; height: 0.5em; border: 1px solid black; border-radius: 50%; margin-right: 0.5em;"></span> Input Volt. 264 V                 </p> <p>                     Note: Slanted line shows the range of the rated load current.                      (注)斜線は定格負荷電流範囲を示す。                 </p>				<p>2. Values</p> <table border="1"> <thead> <tr> <th rowspan="2">Load Current [A]</th> <th colspan="3">Output Voltage [V]</th> </tr> <tr> <th>Input Volt. 170[V]</th> <th>Input Volt. 200[V]</th> <th>Input Volt. 264[V]</th> </tr> </thead> <tbody> <tr><td>0.00</td><td>24.083</td><td>24.085</td><td>24.085</td></tr> <tr><td>0.08</td><td>24.080</td><td>24.081</td><td>24.082</td></tr> <tr><td>0.16</td><td>24.079</td><td>24.080</td><td>24.081</td></tr> <tr><td>0.24</td><td>24.079</td><td>24.079</td><td>24.079</td></tr> <tr><td>0.32</td><td>24.080</td><td>24.080</td><td>24.079</td></tr> <tr><td>0.40</td><td>24.076</td><td>24.076</td><td>24.076</td></tr> <tr><td>0.48</td><td>24.074</td><td>24.075</td><td>24.075</td></tr> <tr><td>0.50</td><td>24.074</td><td>24.074</td><td>24.075</td></tr> <tr><td>0.55</td><td>24.073</td><td>24.072</td><td>24.072</td></tr> <tr><td>—</td><td>—</td><td>—</td><td>—</td></tr> </tbody> </table>				Load Current [A]	Output Voltage [V]			Input Volt. 170[V]	Input Volt. 200[V]	Input Volt. 264[V]	0.00	24.083	24.085	24.085	0.08	24.080	24.081	24.082	0.16	24.079	24.080	24.081	0.24	24.079	24.079	24.079	0.32	24.080	24.080	24.079	0.40	24.076	24.076	24.076	0.48	24.074	24.075	24.075	0.50	24.074	24.074	24.075	0.55	24.073	24.072	24.072	—	—	—	—
Load Current [A]	Output Voltage [V]																																																					
	Input Volt. 170[V]	Input Volt. 200[V]	Input Volt. 264[V]																																																			
0.00	24.083	24.085	24.085																																																			
0.08	24.080	24.081	24.082																																																			
0.16	24.079	24.080	24.081																																																			
0.24	24.079	24.079	24.079																																																			
0.32	24.080	24.080	24.079																																																			
0.40	24.076	24.076	24.076																																																			
0.48	24.074	24.075	24.075																																																			
0.50	24.074	24.074	24.075																																																			
0.55	24.073	24.072	24.072																																																			
—	—	—	—																																																			



<b>Model</b>		LDA10F-24																																								
<b>Item</b>		Ripple Voltage (by Load Current) リップル電圧(負荷電流特性)	Temperature	25°C																																						
<b>Object</b>		+24.0V0.5A	Testing Circuitry	Figure A																																						
<p>1. Graph</p> <p>[mV]</p> <p>-----□----- Input Volt. 170V</p> <p>-----△----- Input Volt. 264V</p>		<p>2. Values</p> <table border="1"> <thead> <tr> <th rowspan="2">Load Current [A]</th> <th>Input Volt. 170 [V]</th> <th>Input Volt. 264 [V]</th> </tr> <tr> <th>Ripple Output Volt. [mV]</th> <th>Ripple Output Volt. [mV]</th> </tr> </thead> <tbody> <tr><td>0.00</td><td>10</td><td>10</td></tr> <tr><td>0.10</td><td>10</td><td>10</td></tr> <tr><td>0.20</td><td>10</td><td>10</td></tr> <tr><td>0.25</td><td>10</td><td>10</td></tr> <tr><td>0.30</td><td>10</td><td>10</td></tr> <tr><td>0.40</td><td>10</td><td>10</td></tr> <tr><td>0.50</td><td>10</td><td>10</td></tr> <tr><td>0.55</td><td>10</td><td>10</td></tr> <tr><td>—</td><td>—</td><td>—</td></tr> <tr><td>—</td><td>—</td><td>—</td></tr> <tr><td>—</td><td>—</td><td>—</td></tr> </tbody> </table>			Load Current [A]	Input Volt. 170 [V]	Input Volt. 264 [V]	Ripple Output Volt. [mV]	Ripple Output Volt. [mV]	0.00	10	10	0.10	10	10	0.20	10	10	0.25	10	10	0.30	10	10	0.40	10	10	0.50	10	10	0.55	10	10	—	—	—	—	—	—	—	—	—
Load Current [A]	Input Volt. 170 [V]	Input Volt. 264 [V]																																								
	Ripple Output Volt. [mV]	Ripple Output Volt. [mV]																																								
0.00	10	10																																								
0.10	10	10																																								
0.20	10	10																																								
0.25	10	10																																								
0.30	10	10																																								
0.40	10	10																																								
0.50	10	10																																								
0.55	10	10																																								
—	—	—																																								
—	—	—																																								
—	—	—																																								
<p>Ripple Voltage is shown as p-p in the figure below.</p> <p>Note: Slanted line shows the range of the rated load current.</p> <p>リップル電圧は、下図 p-p 値で示される。 (注)斜線は定格負荷電流範囲を示す。</p> <p>T1: Due to AC Input Line 入力商用周期 T2: Due to Switching スイッチング周期</p> <p>Fig. Complex Ripple Wave Form 図 リップル波形詳細図</p>																																										



<p>Model LDA10F-24</p>		<p>Temperature 25°C</p>																																							
<p>Item Ripple-Noise リップルノイズ</p>		<p>Testing Circuitry Figure A</p>																																							
<p>Object +24.0V0.5A</p>																																									
<p>1. Graph</p> <p>[mV]</p> <p>□ --- Input Volt. 170V</p> <p>△ --- Input Volt. 264V</p> <p>Ripple-Noise</p> <p>Load Current [A]</p>		<p>2. Values</p> <table border="1"> <thead> <tr> <th rowspan="2">Load current [A]</th> <th>Input Volt. 170 [V]</th> <th>Input Volt. 264 [V]</th> </tr> <tr> <th>Ripple-Noise [mV]</th> <th>Ripple-Noise [mV]</th> </tr> </thead> <tbody> <tr><td>0.00</td><td>10</td><td>10</td></tr> <tr><td>0.10</td><td>15</td><td>15</td></tr> <tr><td>0.20</td><td>15</td><td>15</td></tr> <tr><td>0.25</td><td>15</td><td>15</td></tr> <tr><td>0.30</td><td>15</td><td>15</td></tr> <tr><td>0.40</td><td>15</td><td>15</td></tr> <tr><td>0.50</td><td>20</td><td>15</td></tr> <tr><td>0.55</td><td>20</td><td>15</td></tr> <tr><td>—</td><td>—</td><td>—</td></tr> <tr><td>—</td><td>—</td><td>—</td></tr> <tr><td>—</td><td>—</td><td>—</td></tr> </tbody> </table>		Load current [A]	Input Volt. 170 [V]	Input Volt. 264 [V]	Ripple-Noise [mV]	Ripple-Noise [mV]	0.00	10	10	0.10	15	15	0.20	15	15	0.25	15	15	0.30	15	15	0.40	15	15	0.50	20	15	0.55	20	15	—	—	—	—	—	—	—	—	—
Load current [A]	Input Volt. 170 [V]	Input Volt. 264 [V]																																							
	Ripple-Noise [mV]	Ripple-Noise [mV]																																							
0.00	10	10																																							
0.10	15	15																																							
0.20	15	15																																							
0.25	15	15																																							
0.30	15	15																																							
0.40	15	15																																							
0.50	20	15																																							
0.55	20	15																																							
—	—	—																																							
—	—	—																																							
—	—	—																																							
<p>Ripple-Noise is shown as p-p in the figure below.</p> <p>Note: Slanted line shows the range of the rated load current.</p> <p>リップルノイズは、下図 p-p 値で示される。</p> <p>(注) 斜線は定格負荷電流範囲を示す。</p>																																									
<p>T1: Due to AC Input Line 入力商用周期</p> <p>T2: Due to Switching スイッチング周期</p> <p>Ripple-Noise [mVp-p]</p>																																									
<p>Fig. Complex Ripple Wave Form</p> <p>図 リップル波形詳細図</p>																																									

# COSEL

<p>Model LDA10F-24</p> <p>Item Overcurrent Protection 過電流保護</p> <p>Object +24.0V0.5A</p>		<p>Temperature 25°C</p> <p>Testing Circuitry Figure A</p>																																																						
<p>1. Graph</p> <p>[V]</p> <p>Output Voltage</p> <p>40.0</p> <p>30.0</p> <p>20.0</p> <p>10.0</p> <p>0.0</p> <p>0 0.2 0.4 0.6 0.8 1</p> <p>Load Current [A]</p> <p>                     ——— Input Volt. 170 V                      ——— Input Volt. 200 V                      ——— Input Volt. 264 V                 </p>	<p>2. Values</p> <table border="1"> <thead> <tr> <th rowspan="2">Output Voltage [V]</th> <th colspan="3">Load Current [A]</th> </tr> <tr> <th>Input Volt. 170[V]</th> <th>Input Volt. 200[V]</th> <th>Input Volt. 264[V]</th> </tr> </thead> <tbody> <tr><td>24.00</td><td>0.66</td><td>0.66</td><td>0.67</td></tr> <tr><td>22.80</td><td>0.67</td><td>0.67</td><td>0.69</td></tr> <tr><td>21.60</td><td>0.68</td><td>0.68</td><td>0.70</td></tr> <tr><td>19.20</td><td>0.71</td><td>0.71</td><td>0.73</td></tr> <tr><td>16.80</td><td>0.74</td><td>0.74</td><td>0.76</td></tr> <tr><td>14.40</td><td>0.76</td><td>0.76</td><td>0.78</td></tr> <tr><td>12.00</td><td>0.78</td><td>0.77</td><td>0.80</td></tr> <tr><td>9.60</td><td>0.79</td><td>0.78</td><td>0.81</td></tr> <tr><td>7.20</td><td>0.78</td><td>0.78</td><td>0.81</td></tr> <tr><td>4.80</td><td>0.75</td><td>0.75</td><td>0.79</td></tr> <tr><td>2.40</td><td>0.67</td><td>0.68</td><td>0.74</td></tr> <tr><td>0.00</td><td>0.50</td><td>0.51</td><td>0.59</td></tr> </tbody> </table>	Output Voltage [V]	Load Current [A]			Input Volt. 170[V]	Input Volt. 200[V]	Input Volt. 264[V]	24.00	0.66	0.66	0.67	22.80	0.67	0.67	0.69	21.60	0.68	0.68	0.70	19.20	0.71	0.71	0.73	16.80	0.74	0.74	0.76	14.40	0.76	0.76	0.78	12.00	0.78	0.77	0.80	9.60	0.79	0.78	0.81	7.20	0.78	0.78	0.81	4.80	0.75	0.75	0.79	2.40	0.67	0.68	0.74	0.00	0.50	0.51	0.59
Output Voltage [V]	Load Current [A]																																																							
	Input Volt. 170[V]	Input Volt. 200[V]	Input Volt. 264[V]																																																					
24.00	0.66	0.66	0.67																																																					
22.80	0.67	0.67	0.69																																																					
21.60	0.68	0.68	0.70																																																					
19.20	0.71	0.71	0.73																																																					
16.80	0.74	0.74	0.76																																																					
14.40	0.76	0.76	0.78																																																					
12.00	0.78	0.77	0.80																																																					
9.60	0.79	0.78	0.81																																																					
7.20	0.78	0.78	0.81																																																					
4.80	0.75	0.75	0.79																																																					
2.40	0.67	0.68	0.74																																																					
0.00	0.50	0.51	0.59																																																					
<p>Note: Slanted line shows the range of the rated load current.</p> <p>(注)斜線は定格負荷電流範囲を示す。</p>																																																								

# COSEL

Model	LDA10F-24	Temperature	25°C
Item	Inrush Current 突入電流	Testing Circuitry	Figure A
Object	_____		

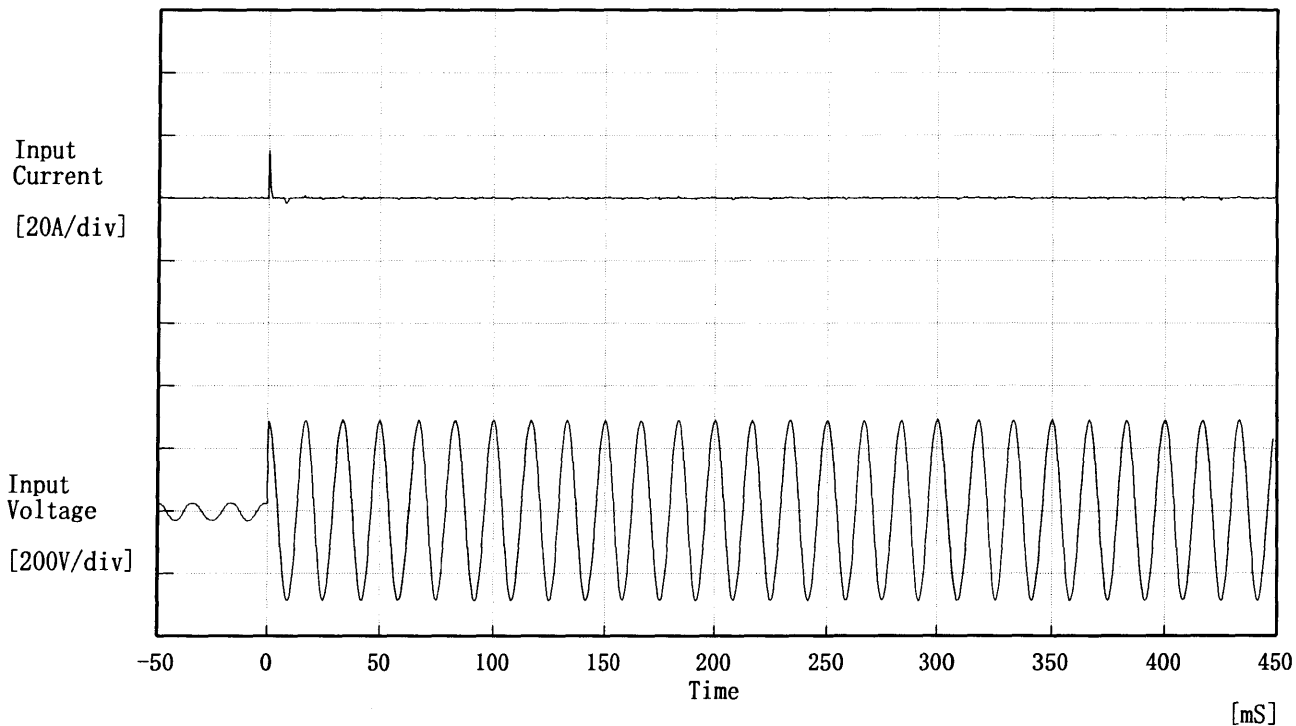

Input Voltage 200 V  
 Frequency 60 Hz  
 Load 100 %  
 Inrush Current  
 ① 15.19 [A]  
 ② 0.81 [A]

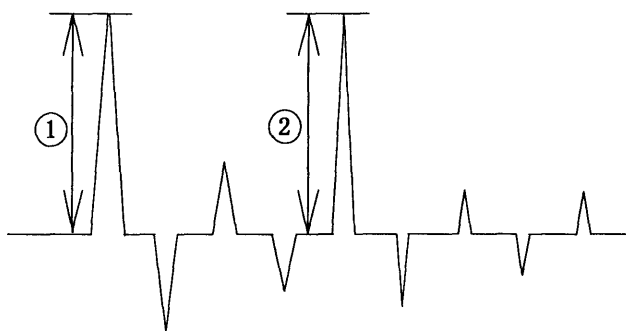

# COSEL

Model	LDA10F-24	Temperature	25°C
Item	Dynamic Load Responce 動的負荷変動	Testing Circuitry	Figure A
Object	+24.0V0.5A		

Input Volt. 200 V  
Cycle 1000 mS

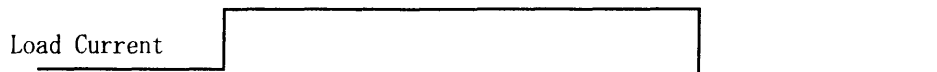

Load 0% ↔  
Load 100 %

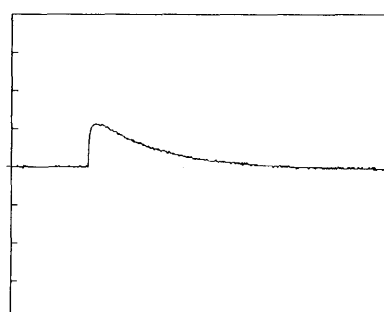
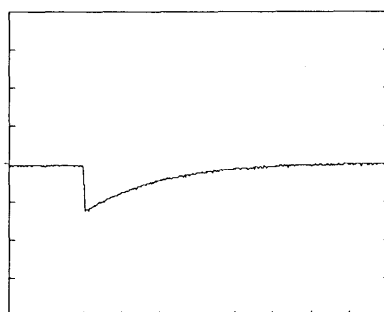

Load 0% ↔  
Load 50 %

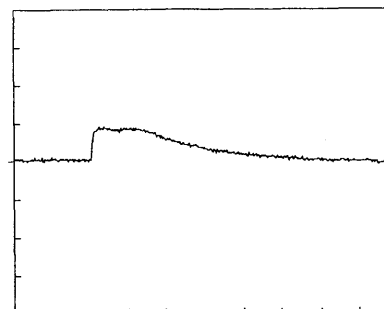
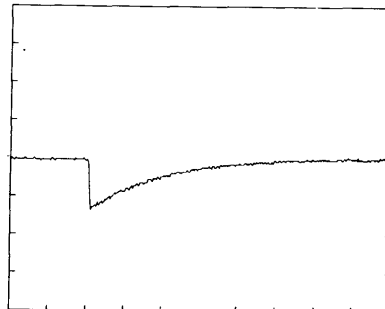

200 mV/div

10 mS/div

# COSEL

Model	LDA10F-24	Temperature	25°C
Item	Rise and Fall Time 立上り、立下り時間	Testing Circuitry	Figure A
Object	+24.0V0.5A		

1. Graph

Input Volt. 170 V

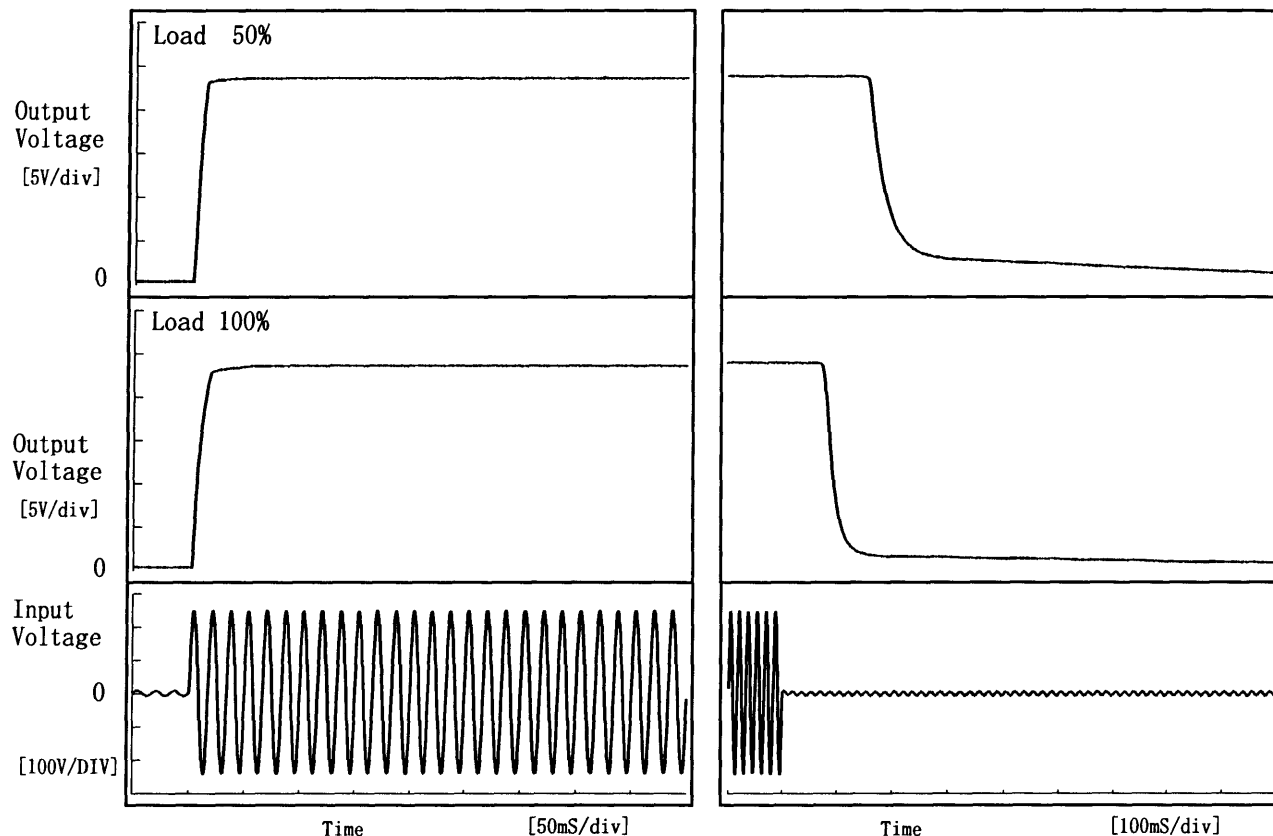

2. Values

[mS]

Load \ Time	T <sub>d</sub>	T <sub>r</sub>	T <sub>s</sub>	T <sub>h</sub>	T <sub>f</sub>
50 %	2.8	10.3	13.0	161.5	300.0
100 %	2.8	14.3	17.0	80.5	52.5

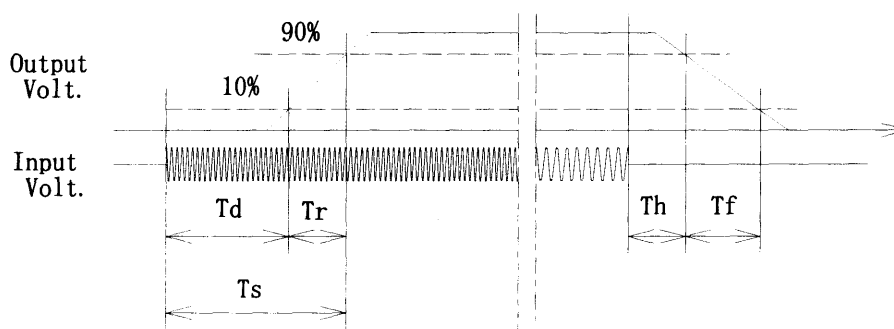





Model	LDA10F-24
Item	Ambient Temperature Drift 周囲温度変動
Object	+24.0V0.5A

Testing Circuitry Figure A

1. Graph

—△— Input Volt. 170V  
 - - -□- - - Input Volt. 200V  
 - - -○- - - Input Volt. 264V

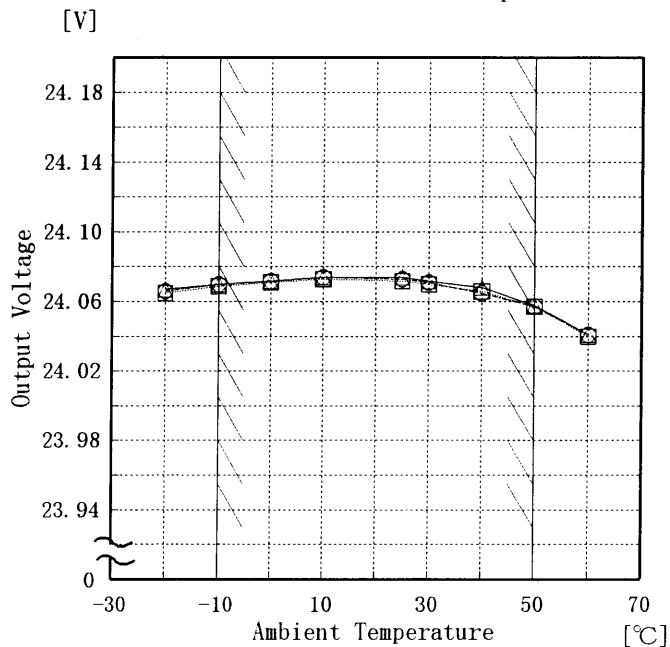

Note: Slanted line shows the range of the rated ambient temperature.

(注)斜線は定格周囲温度範囲を示す。

2. Values

Temperature [°C]	Output Voltage [V]		
	Input Volt. 170[V]	Input Volt. 200[V]	Input Volt. 264[V]
-20	24.067	24.065	24.066
-10	24.070	24.069	24.070
0	24.072	24.071	24.072
10	24.074	24.073	24.074
25	24.074	24.072	24.073
30	24.072	24.070	24.071
40	24.068	24.066	24.065
50	24.058	24.057	24.057
60	24.041	24.040	24.041
-	-	-	-
-	-	-	-



Model	LDA10F-24
Item	Minimum Input Voltage for Regulated Output Voltage 最低レギュレーション電圧
Object	+24.0V0.5A

Testing Circuitry Figure A

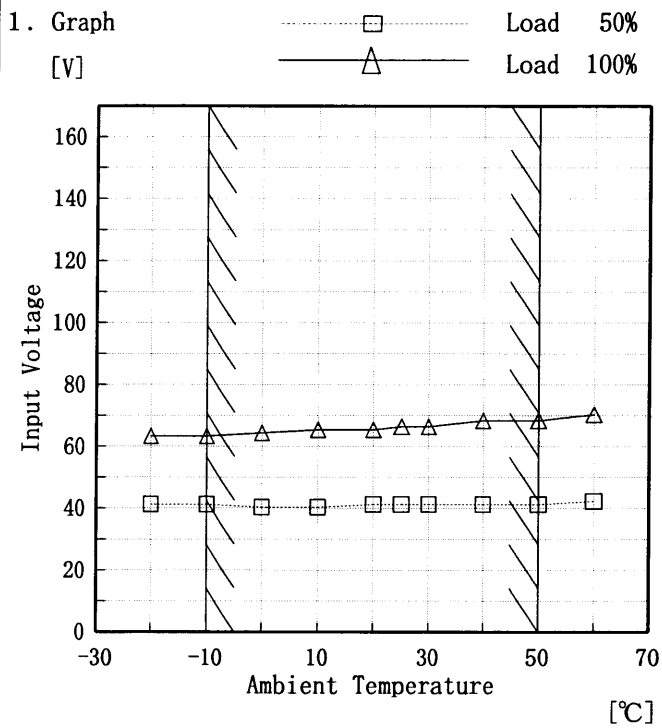

2. Values

Ambient Temperature [°C]	Input Voltage [V]	
	Load 50%	Load 100%
-20	41	63
-10	41	63
0	40	64
10	40	65
20	41	65
25	41	66
30	41	66
40	41	68
50	41	68
60	42	70
—	—	—

Note: Slanted line shows the range of the rated ambient temperature.

(注) 斜線は定格周囲温度範囲を示す。



Model		LDA10F-24	Testing Circuitry Figure A																																				
Item		Ripple Voltage (by Ambient Temp.) リップル電圧 (周囲温度特性)																																					
Object		+24.0V0.5A																																					
1. Graph		<div style="display: flex; justify-content: space-around;"> <span>□ Load 50%</span> <span>△ Load 100%</span> </div> <p style="text-align: center;">Input Volt. 200 V</p> <p>Note: Slanted line shows the range of the rated ambient temperature.</p> <p>(注)斜線は定格周囲温度範囲を示す。</p>	2. Values																																				
		<table border="1"> <thead> <tr> <th>Ambient Temp. [°C]</th> <th>Load 50% Ripple Output Volt. [mV]</th> <th>Load 100% Ripple Output Volt. [mV]</th> </tr> </thead> <tbody> <tr><td>-20</td><td>25</td><td>50</td></tr> <tr><td>-10</td><td>15</td><td>20</td></tr> <tr><td>0</td><td>15</td><td>20</td></tr> <tr><td>10</td><td>15</td><td>20</td></tr> <tr><td>20</td><td>10</td><td>15</td></tr> <tr><td>25</td><td>10</td><td>15</td></tr> <tr><td>30</td><td>10</td><td>10</td></tr> <tr><td>40</td><td>10</td><td>10</td></tr> <tr><td>50</td><td>10</td><td>10</td></tr> <tr><td>60</td><td>10</td><td>10</td></tr> <tr><td>—</td><td>—</td><td>—</td></tr> </tbody> </table>	Ambient Temp. [°C]	Load 50% Ripple Output Volt. [mV]	Load 100% Ripple Output Volt. [mV]	-20	25	50	-10	15	20	0	15	20	10	15	20	20	10	15	25	10	15	30	10	10	40	10	10	50	10	10	60	10	10	—	—	—	
Ambient Temp. [°C]	Load 50% Ripple Output Volt. [mV]	Load 100% Ripple Output Volt. [mV]																																					
-20	25	50																																					
-10	15	20																																					
0	15	20																																					
10	15	20																																					
20	10	15																																					
25	10	15																																					
30	10	10																																					
40	10	10																																					
50	10	10																																					
60	10	10																																					
—	—	—																																					



<b>COSEL</b>																									
Model	LDA10F-24	Temperature	25°C																						
Item	Time Lapse Drift 経時ドリフト	Testing Circuitry	Figure A																						
Object	+24.0V0.5A																								
<p>1. Graph</p> <p>[V]</p> <p>Output Voltage</p> <p>Time [H]</p> <p>Input Volt. 200V Load 100%</p>		<p>2. Values</p> <table border="1"> <thead> <tr> <th>Time since start [H]</th> <th>Output Voltage [V]</th> </tr> </thead> <tbody> <tr><td>0.0</td><td>24.075</td></tr> <tr><td>0.5</td><td>24.064</td></tr> <tr><td>1.0</td><td>24.067</td></tr> <tr><td>2.0</td><td>24.067</td></tr> <tr><td>3.0</td><td>24.065</td></tr> <tr><td>4.0</td><td>24.067</td></tr> <tr><td>5.0</td><td>24.067</td></tr> <tr><td>6.0</td><td>24.067</td></tr> <tr><td>7.0</td><td>24.067</td></tr> <tr><td>8.0</td><td>24.066</td></tr> </tbody> </table>		Time since start [H]	Output Voltage [V]	0.0	24.075	0.5	24.064	1.0	24.067	2.0	24.067	3.0	24.065	4.0	24.067	5.0	24.067	6.0	24.067	7.0	24.067	8.0	24.066
Time since start [H]	Output Voltage [V]																								
0.0	24.075																								
0.5	24.064																								
1.0	24.067																								
2.0	24.067																								
3.0	24.065																								
4.0	24.067																								
5.0	24.067																								
6.0	24.067																								
7.0	24.067																								
8.0	24.066																								



<b>COSEL</b>		
Model	LDA10F-24	
Item	Output Voltage Accuracy 定電圧精度	Testing Circuitry Figure A
Object	+24.0V0.5A	

**Output Voltage Accuracy**

This is defined as the value of the output voltage, regulation load, ambient temperature and input voltage varied at random in the range as specified below.

Temperature -10~50 °C

Input Voltage : 170~264 V

Load Current : 0~0.5 A

\* Output Voltage Accuracy =  $\pm (\text{Maximum of Output Voltage} - \text{Minimum of Output Voltage}) / 2$

\* Output Voltage Accuracy (Ration) =  $\frac{\text{Output Voltage Accuracy}}{\text{Rated Output Voltage}} \times 100$

**定電圧精度**

周囲温度、入力電圧、負荷電流を下記仕様内で、任意に変動させたときの出力電圧の変動をいう。

周囲温度 -10~50 °C

入力電圧 170~264 V

負荷電流 0~0.5 A

\* 定電圧精度(変動値) =  $\pm (\text{出力電圧の最高値} - \text{出力電圧の最低値}) / 2$

\* 定電圧精度(変動率) =  $\frac{\text{変動値}}{\text{定格出力電圧}} \times 100$

Item	Temperature [°C]	Input Voltage [V]	Output Current [A]	Output Voltage [V]	Output Voltage Accuracy [mV]	Output Voltage Accuracy (Ration) [%]
Maximum Voltage	25	200	0.0	24.084	±20	±0.1
Minimum Voltage	50	200	0.5	24.045		

# COSEL

<b>COSEL</b>		
Model	LDA10F-24	
Item	Condensation 結露特性	Testing Circuitry Figure A
Object	+24.0V 0.5A	

1. Condensation test

Testing procedure is as follows.

- ① Keeping and cooling the unit in a tank at -10°C for an hour with the input off.
- ② Taking it out of the tank and dewing itself in a room where the temperature is 25°C and the humidity is 40%RH.
- ③ Testing electrical characteristics of the unit to confirm there be no fault.

1. 結露特性試験

入力を切った状態で、恒温槽で-10℃に冷却しておき、約1時間後に恒温槽から取り出し、室温25℃、湿度40%RHの状態におき結露させ、その電気的特性の測定を行い、異常のないことを確認する。

2. Values

Item	Data	Testing Conditions
Output Voltage [V]	24.08	Input Volt. : 200V, Load Current:0.5A
Line Regulation [mV]	3	Input Volt. : 170~264V, Load Current:0.5A
Load Regulation [mV]	12	Input Volt. : 200V, Load Current:0~0.5A



Model		LDA10F-24	Temperature	25°C
Item		Leakage Current 漏洩電流	Testing Circuitry	Figure B
Object		_____		

1. Results

Standards	Leakage Current [mA]		
	Input Volt. 85 [V]	Input Volt. 100 [V]	Input Volt. 132 [V]
(A) DENTORI	---	---	---
(B) IEC60950	---	---	---

Standards	Leakage Current [mA]		
	Input Volt. 170 [V]	Input Volt. 230 [V]	Input Volt. 264 [V]
(B) IEC60950	0.23	0.25	0.28

2. Condition

Leakage current value is concluded after measuring both phases of AC input and by choosing the larger one.

交流入力 of 両相について測定し、その大きい方を漏洩電流測定値とする。

# COSEL

Model	LDA10F-24	Temperature 25°C Testing Circuitry Figure C
Item	Line Noise Tolerance 入力雑音耐量	
Object	+24.0V0.5A	

1. Results

Pulse Width [ nS ]	MODE	No protection failure should occur 保護回路の誤動作がない	DC-like Regulation of Output Voltage 出力電圧の直流的変動
50	COMMON	OK	no fluctuation
	NORMAL	OK	no fluctuation
1000	COMMON	OK	no fluctuation
	NORMAL	OK	no fluctuation

2. Conditions

Input Voltage : 200 V  
 Pulse Voltage : 2000 V  
 Pulse Cycle : 10 mS  
 Pulse Input Duration : 1 min. or more  
 Load : 100 %





Model	LDA10F-24	Temperature	25°C
Item	Conducted Emission 雑音端子電圧	Testing Circuitry	Figure D
Object	_____		

1. Graph

Remarks

Input Volt. 230 V

Load 100 %

規格 1 : [EN 55022] Class B (平均値)

規格 2 : [EN 55022] Class B (QP)

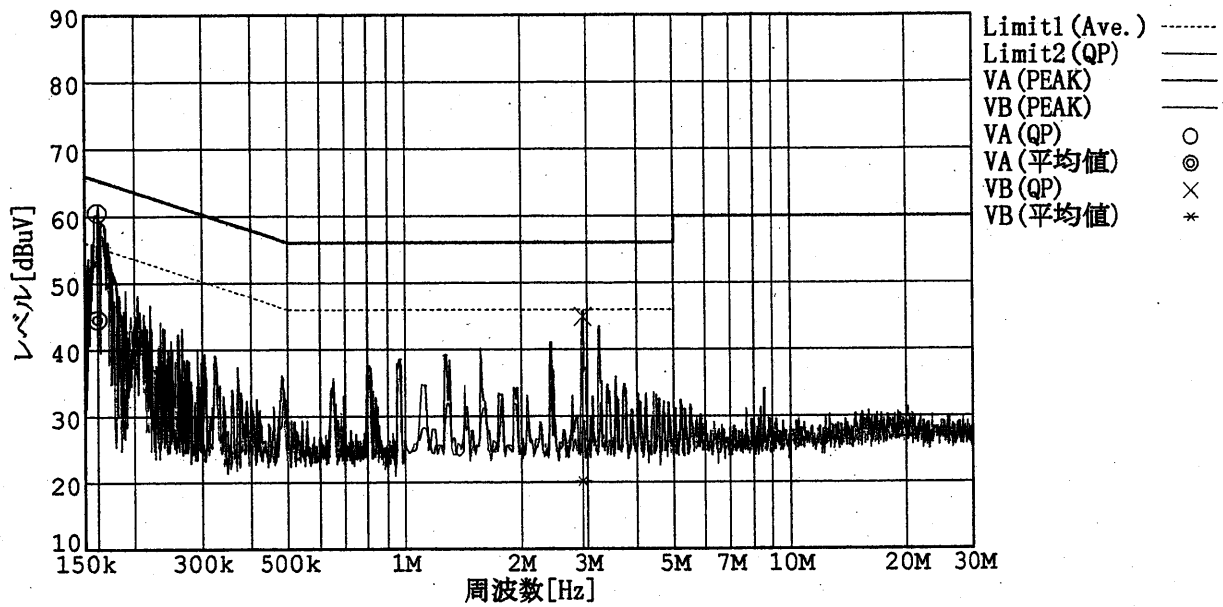

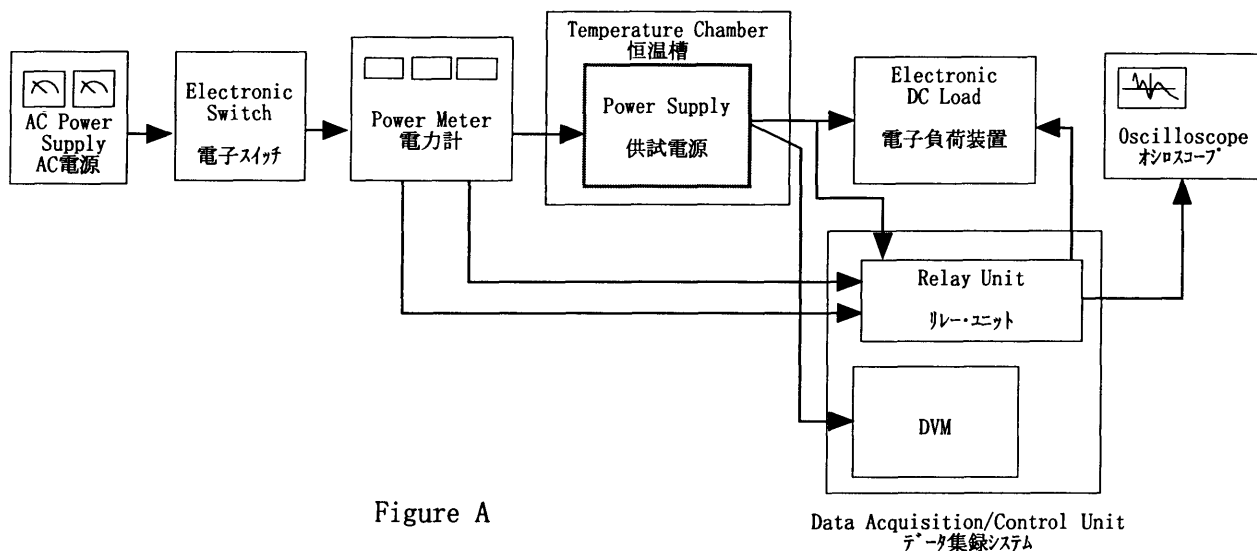

Figure A

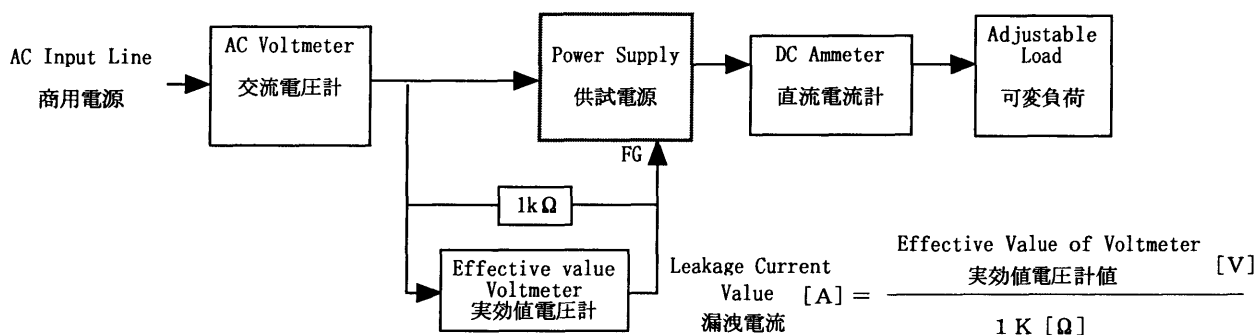

Figure B (DENTORI)

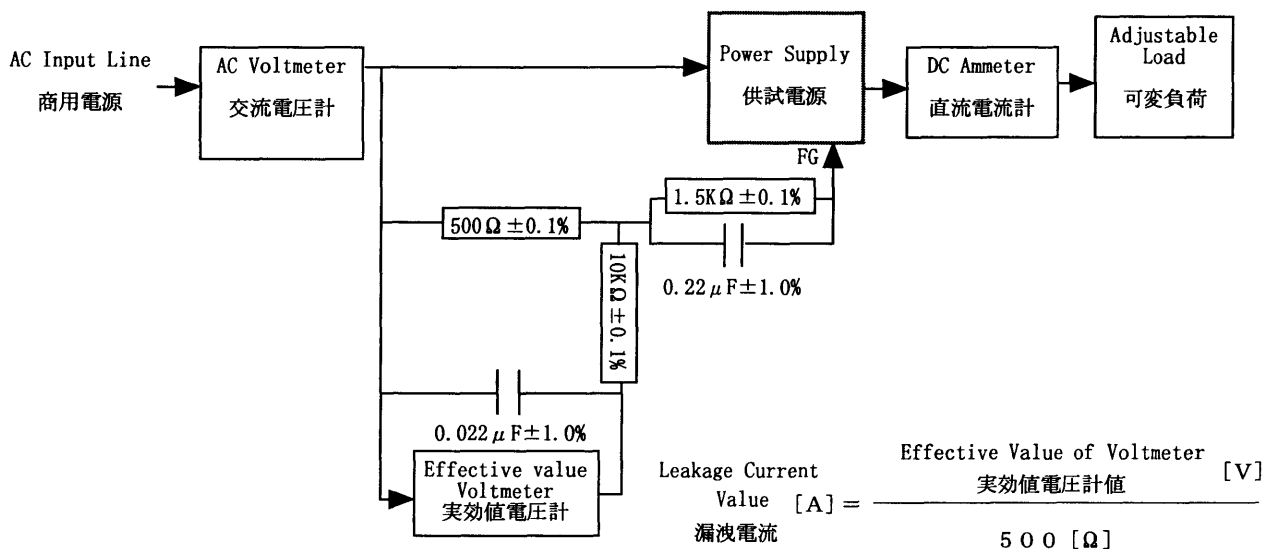

Figure B (IEC 60950)

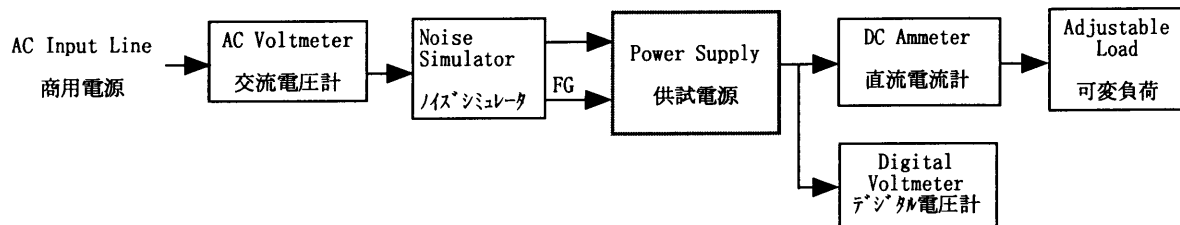

Figure C

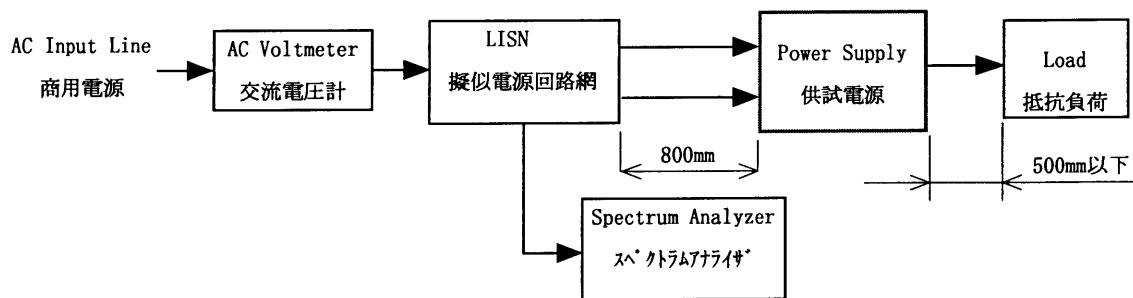

Figure D

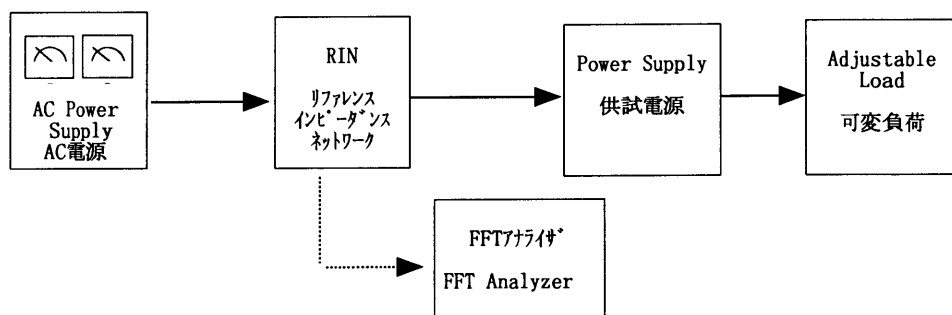

Figure E