



TEST DATA OF LCA15S-5 (100V INPUT)

Regulated DC Power Supply

Date : June 17. 1999

Approved by : *H. Yamaguchi*
Design Manager

Prepared by : *S. Taniguchi*
Design Engineer

コーセル株式会社

COSEL CO., LTD.

CONTENTS

1. Line Regulation	1
<small>静的入力変動</small>	
2. Input Current (by Load Current)	2
<small>入力電流 (負荷特性)</small>	
3. Input Power (by Load Current)	3
<small>入力電力 (負荷特性)</small>	
4. Efficiency (by Input Voltage)	4
<small>効率 (入力電圧特性)</small>	
5. Efficiency (by Load Current)	5
<small>効率 (負荷特性)</small>	
6. Hold-Up Time	6
<small>出力保持時間</small>	
7. Instantaneous Interruption Compensation	7
<small>瞬時停電保障</small>	
8. Load Regulation	8
<small>静的負荷変動</small>	
9. Ripple Voltage (by Load Current)	9
<small>リップル電圧 (負荷特性)</small>	
10. Ripple-Noise	10
<small>リップルノイズ</small>	
11. Overcurrent Protection	11
<small>過電流保護</small>	
12. Inrush Current	12
<small>突入電流</small>	
13. Dynamic Load Responce	13
<small>動的負荷変動</small>	
14. Rise and Fall Time	14
<small>立上り、立下がり時間</small>	
15. Ambient Temperature Drift	15
<small>周囲温度変動</small>	
16. Minimum Input Voltage for Regulated Output Voltage .	16
<small>最低レギュレーション電圧</small>	
17. Ripple Voltage (by Ambient Temperature)	17
<small>リップル電圧 (周囲温度特性)</small>	
18. Time Lapse Drift	18
<small>経時ドリフト</small>	
19. Output Voltage Accuracy	19
<small>定電圧精度</small>	
20. Condensation	20
<small>結露特性</small>	
21. Leakage Current	21
<small>漏洩電流</small>	
22. Line Noise Tolerance	22
<small>入力雑音耐量</small>	
23. Conducted Emission	23
<small>雑音端子電圧</small>	
24. Figure of Testing Circuitry	24
<small>測定回路図</small>	

(Final Page 25)



Model	LCA15S-5
Item	Line Regulation 静的入力変動
Object	+5.0V3A

Temperature 25°C
Testing Circuitry Figure A

1. Graph
 □ Load 50%
 △ Load 100%

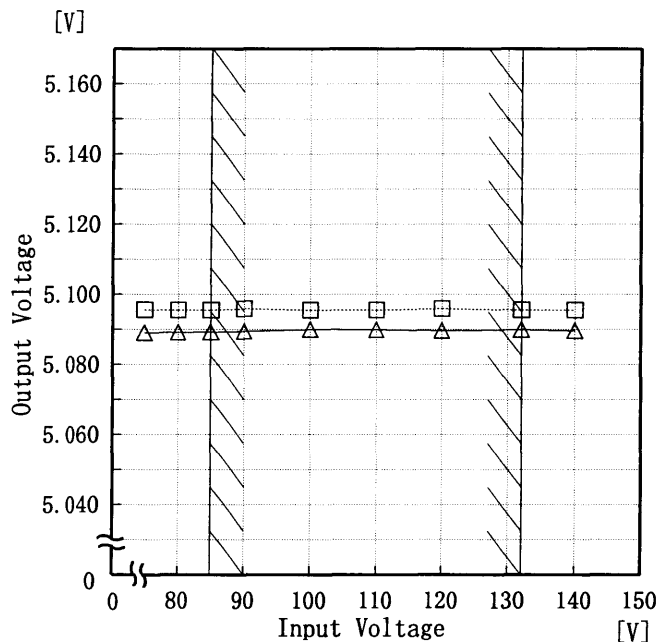

Note: Slanted line shows the range of the rated input voltage.

(注)斜線は定格入力電圧範囲を示す。

2. Values

Input Voltage [V]	Output Voltage [V]	
	Load 50%	Load 100%
75	5.096	5.089
80	5.096	5.089
85	5.096	5.089
90	5.096	5.089
100	5.096	5.090
110	5.096	5.090
120	5.096	5.090
132	5.096	5.090
140	5.096	5.090



Model		LCA15S-5		Temperature		25°C																																																								
Item		Input Current (by Load Current) 入力電流 (負荷特性)		Testing Circuitry		Figure A																																																								
Output		_____																																																												
1. Graph				2. Values																																																										
<p> \triangle — Input Volt. 85V \square — Input Volt. 100V \circ — Input Volt. 132V </p>																																																														
				<table border="1"> <thead> <tr> <th rowspan="2">Load Current [A]</th> <th colspan="3">Input Current [A]</th> </tr> <tr> <th>Input Volt. 85[V]</th> <th>Input Volt. 100[V]</th> <th>Input Volt. 132[V]</th> </tr> </thead> <tbody> <tr><td>0.0</td><td>0.032</td><td>0.029</td><td>0.026</td></tr> <tr><td>0.6</td><td>0.110</td><td>0.104</td><td>0.097</td></tr> <tr><td>1.2</td><td>0.178</td><td>0.162</td><td>0.144</td></tr> <tr><td>1.8</td><td>0.248</td><td>0.222</td><td>0.190</td></tr> <tr><td>2.4</td><td>0.321</td><td>0.284</td><td>0.237</td></tr> <tr><td>3.0</td><td>0.395</td><td>0.347</td><td>0.285</td></tr> <tr><td>3.3</td><td>0.433</td><td>0.380</td><td>0.310</td></tr> <tr><td>—</td><td>—</td><td>—</td><td>—</td></tr> <tr><td>—</td><td>—</td><td>—</td><td>—</td></tr> <tr><td>—</td><td>—</td><td>—</td><td>—</td></tr> <tr><td>—</td><td>—</td><td>—</td><td>—</td></tr> <tr><td>—</td><td>—</td><td>—</td><td>—</td></tr> </tbody> </table>				Load Current [A]	Input Current [A]			Input Volt. 85[V]	Input Volt. 100[V]	Input Volt. 132[V]	0.0	0.032	0.029	0.026	0.6	0.110	0.104	0.097	1.2	0.178	0.162	0.144	1.8	0.248	0.222	0.190	2.4	0.321	0.284	0.237	3.0	0.395	0.347	0.285	3.3	0.433	0.380	0.310	—	—	—	—	—	—	—	—	—	—	—	—	—	—	—	—	—	—	—	—
Load Current [A]	Input Current [A]																																																													
	Input Volt. 85[V]	Input Volt. 100[V]	Input Volt. 132[V]																																																											
0.0	0.032	0.029	0.026																																																											
0.6	0.110	0.104	0.097																																																											
1.2	0.178	0.162	0.144																																																											
1.8	0.248	0.222	0.190																																																											
2.4	0.321	0.284	0.237																																																											
3.0	0.395	0.347	0.285																																																											
3.3	0.433	0.380	0.310																																																											
—	—	—	—																																																											
—	—	—	—																																																											
—	—	—	—																																																											
—	—	—	—																																																											
—	—	—	—																																																											
<p>Note: Slanted line shows the range of the rated load current</p> <p>(注) 斜線は定格負荷電流範囲を示す。</p>																																																														



Model		LCA15S-5		Temperature		25°C																																																								
Item		Input Power (by Load Current) 入力電力 (負荷特性)		Testing Circuitry		Figure A																																																								
Output		_____																																																												
1. Graph				2. Values																																																										
<p> △ Input Volt. 85V □ Input Volt. 100V ○ Input Volt. 132V </p>				<table border="1"> <thead> <tr> <th rowspan="2">Load Current [A]</th> <th colspan="3">Input Power [W]</th> </tr> <tr> <th>Input Volt. 85[V]</th> <th>Input Volt. 100[V]</th> <th>Input Volt. 132[V]</th> </tr> </thead> <tbody> <tr><td>0.0</td><td>1.13</td><td>1.15</td><td>1.24</td></tr> <tr><td>0.6</td><td>4.93</td><td>5.28</td><td>6.11</td></tr> <tr><td>1.2</td><td>8.65</td><td>8.90</td><td>9.70</td></tr> <tr><td>1.8</td><td>12.64</td><td>12.73</td><td>13.30</td></tr> <tr><td>2.4</td><td>16.83</td><td>16.77</td><td>17.08</td></tr> <tr><td>3.0</td><td>21.21</td><td>20.97</td><td>21.02</td></tr> <tr><td>3.3</td><td>23.54</td><td>23.19</td><td>23.11</td></tr> <tr><td>—</td><td>—</td><td>—</td><td>—</td></tr> <tr><td>—</td><td>—</td><td>—</td><td>—</td></tr> <tr><td>—</td><td>—</td><td>—</td><td>—</td></tr> <tr><td>—</td><td>—</td><td>—</td><td>—</td></tr> <tr><td>—</td><td>—</td><td>—</td><td>—</td></tr> </tbody> </table>				Load Current [A]	Input Power [W]			Input Volt. 85[V]	Input Volt. 100[V]	Input Volt. 132[V]	0.0	1.13	1.15	1.24	0.6	4.93	5.28	6.11	1.2	8.65	8.90	9.70	1.8	12.64	12.73	13.30	2.4	16.83	16.77	17.08	3.0	21.21	20.97	21.02	3.3	23.54	23.19	23.11	—	—	—	—	—	—	—	—	—	—	—	—	—	—	—	—	—	—	—	—
Load Current [A]	Input Power [W]																																																													
	Input Volt. 85[V]	Input Volt. 100[V]	Input Volt. 132[V]																																																											
0.0	1.13	1.15	1.24																																																											
0.6	4.93	5.28	6.11																																																											
1.2	8.65	8.90	9.70																																																											
1.8	12.64	12.73	13.30																																																											
2.4	16.83	16.77	17.08																																																											
3.0	21.21	20.97	21.02																																																											
3.3	23.54	23.19	23.11																																																											
—	—	—	—																																																											
—	—	—	—																																																											
—	—	—	—																																																											
—	—	—	—																																																											
—	—	—	—																																																											
<p>Note: Slanted line shows the range of the rated load current</p> <p>(注) 斜線は定格負荷電流範囲を示す。</p>																																																														



Model	LCA15S-5
Item	Efficiency 効率
Object	_____

Temperature 25°C
Testing Circuitry Figure A

1. Graph

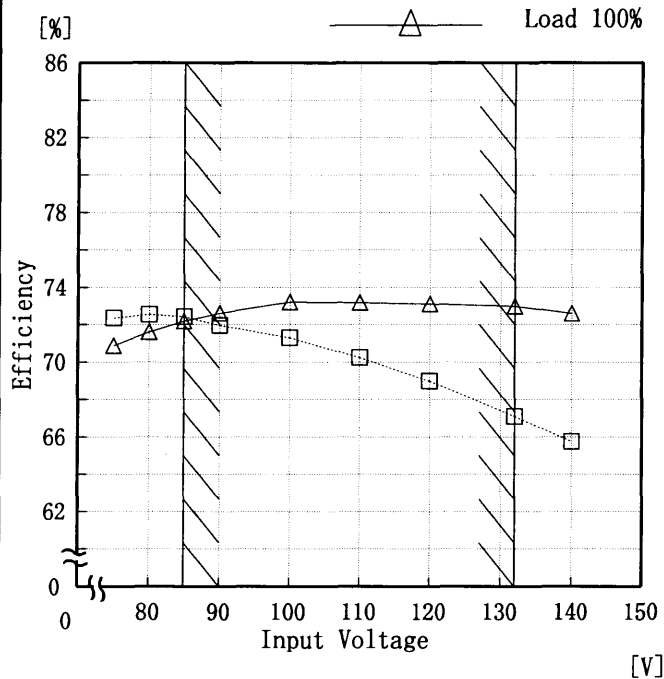

2. Values

Input Voltage [V]	Efficiency [%]	
	Load 50%	Load 100%
75	72.4	70.9
80	72.6	71.6
85	72.4	72.2
90	72.0	72.6
100	71.3	73.2
110	70.2	73.2
120	69.0	73.1
132	67.1	73.0
140	65.8	72.6

Note: Slanted line shows the range of the rated input voltage.

(注) 斜線は定格入力電圧範囲を示す。



Model	LCA15S-5
Item	Efficiency (by Load Current) 効率 (負荷電流特性)
Output	_____

Temperature 25°C
Testing Circuitry Figure A

1. Graph

- △— Input Volt. 85V
- Input Volt. 100V
- Input Volt. 132V

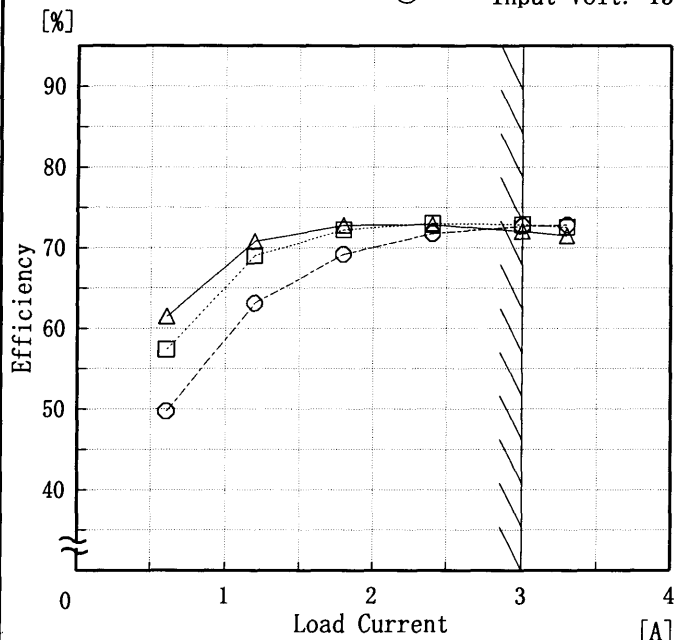

Note: Slanted line shows the range of the rated load current

(注) 斜線は定格負荷電流範囲を示す。

2. Values

Load Current [A]	Efficiency [%]		
	Input Volt. 85[V]	Input Volt. 100[V]	Input Volt. 132[V]
0.6	61.5	57.4	49.7
1.2	70.8	69.0	63.1
1.8	72.8	72.3	69.2
2.4	72.9	73.0	71.8
3.0	72.0	72.9	72.7
3.3	71.5	72.6	72.8
—	—	—	—
—	—	—	—
—	—	—	—
—	—	—	—
—	—	—	—
—	—	—	—
—	—	—	—



Model	LCA15S-5
Item	Hold-Up Time 出力保持時間
Object	+5.0V3A

Temperature 25°C
Testing Circuitry Figure A

1. Graph □ Load 50%
△ Load 100%

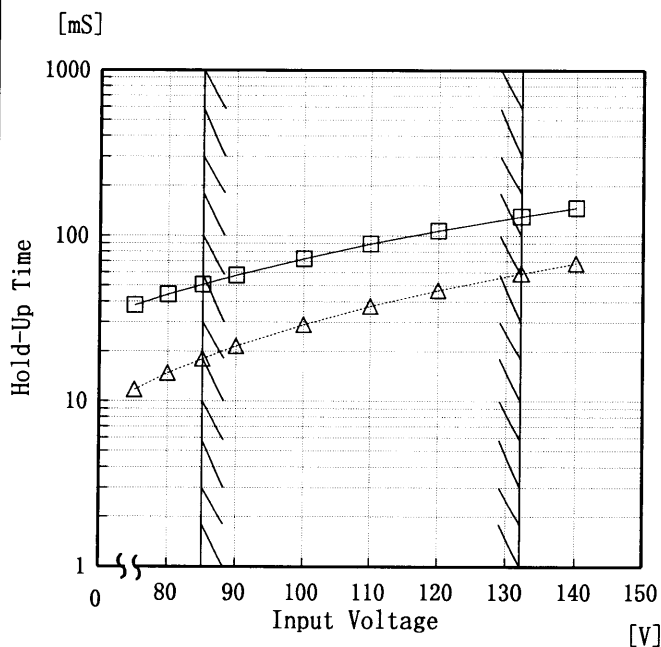

2. Values

Input Voltage [V]	Hold-Up Time [mS]	
	Load 50%	Load 100%
75	38	12
80	44	15
85	51	18
90	58	22
100	73	29
110	89	38
120	107	47
132	131	59
140	148	68

This duration covers from Shut-off of input voltage to the moment when output voltage descends to the rated range of voltage accuracy.

Note: Slanted line shows the range of the rated input voltage.

出力保持時間とは、入力電圧断から出力電圧が、定電圧精度の規格範囲を保持しているところまでの時間。

(注) 斜線は定格入力電圧範囲を示す。



Model		LCA15S-5		Temperature		25°C																																																				
Item		Instantaneous Interruption Compensation 瞬時停電保障		Testing Circuitry		Figure A																																																				
Object		+5.0V3A																																																								
1. Graph				2. Values																																																						
<p> \triangle Input Volt. 85 V \square Input Volt. 100 V \circ Input Volt. 132 V </p>				<table border="1"> <thead> <tr> <th rowspan="2">Load Current [A]</th> <th colspan="3">Time [mS]</th> </tr> <tr> <th>Input Volt. 85[V]</th> <th>Input Volt. 100[V]</th> <th>Input Volt. 132[V]</th> </tr> </thead> <tbody> <tr><td>0.0</td><td>—</td><td>—</td><td>—</td></tr> <tr><td>0.6</td><td>123</td><td>169</td><td>285</td></tr> <tr><td>1.2</td><td>62</td><td>89</td><td>160</td></tr> <tr><td>1.8</td><td>35</td><td>53</td><td>102</td></tr> <tr><td>2.4</td><td>22</td><td>31</td><td>73</td></tr> <tr><td>3.0</td><td>12</td><td>22</td><td>51</td></tr> <tr><td>3.3</td><td>5</td><td>14</td><td>43</td></tr> <tr><td>—</td><td>—</td><td>—</td><td>—</td></tr> <tr><td>—</td><td>—</td><td>—</td><td>—</td></tr> <tr><td>—</td><td>—</td><td>—</td><td>—</td></tr> <tr><td>—</td><td>—</td><td>—</td><td>—</td></tr> </tbody> </table>				Load Current [A]	Time [mS]			Input Volt. 85[V]	Input Volt. 100[V]	Input Volt. 132[V]	0.0	—	—	—	0.6	123	169	285	1.2	62	89	160	1.8	35	53	102	2.4	22	31	73	3.0	12	22	51	3.3	5	14	43	—	—	—	—	—	—	—	—	—	—	—	—	—	—	—	—
Load Current [A]	Time [mS]																																																									
	Input Volt. 85[V]	Input Volt. 100[V]	Input Volt. 132[V]																																																							
0.0	—	—	—																																																							
0.6	123	169	285																																																							
1.2	62	89	160																																																							
1.8	35	53	102																																																							
2.4	22	31	73																																																							
3.0	12	22	51																																																							
3.3	5	14	43																																																							
—	—	—	—																																																							
—	—	—	—																																																							
—	—	—	—																																																							
—	—	—	—																																																							
<p>This duration covers from Shut-off of input voltage to the moment when output voltage descends to the rated range of voltage accuracy. Note: Slanted line shows the range of the rated load current.</p>																																																										
<p>瞬時停電保障時間とは、出力電圧が定電圧精度の規格範囲を保持している瞬時停電時間をいう。 (注) 斜線は定格負荷電流範囲を示す。</p>																																																										



Model	LCA15S-5
Item	Load Regulation 静的負荷変動
Object	+5.0V3A

Temperature 25°C
Testing Circuitry Figure A

1. Graph

—△— Input Volt. 85 V
 - - -□- - - Input Volt. 100 V
 - - -○- - - Input Volt. 132 V

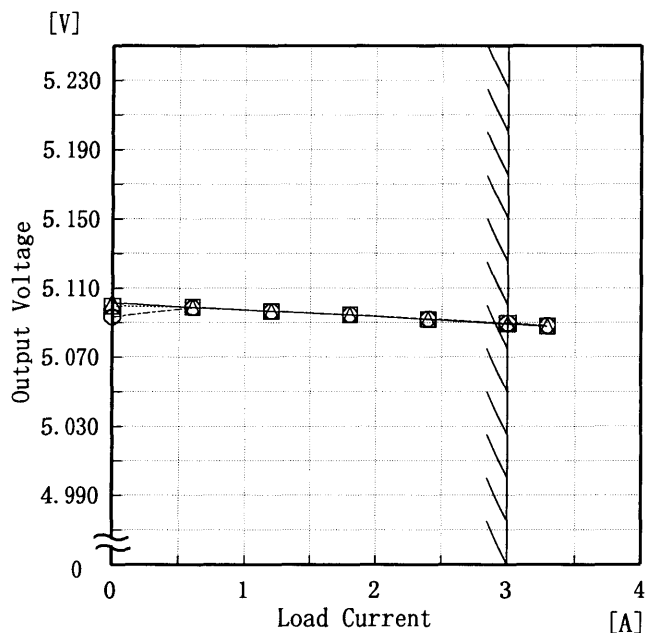

Note: Slanted line shows the range of the rated load current.

(注)斜線は定格負荷電流範囲を示す。

2. Values

Load Current [A]	Output Voltage [V]		
	Input Volt. 85[V]	Input Volt. 100[V]	Input Volt. 132[V]
0.0	5.101	5.100	5.093
0.6	5.099	5.099	5.099
1.2	5.097	5.097	5.097
1.8	5.094	5.095	5.095
2.4	5.092	5.092	5.092
3.0	5.089	5.090	5.090
3.3	5.088	5.088	5.088
—	—	—	—
—	—	—	—
—	—	—	—



Model		LCA15S-5																																							
Item		Ripple Voltage (by Load Current) リップル電圧(負荷電流特性)																																							
Object		+5.0V3A																																							
1. Graph		2. Values																																							
<p>-----□----- Input Volt. 85V -----△----- Input Volt. 132V</p>		<table border="1"> <thead> <tr> <th rowspan="2">Load Current [A]</th> <th>Input Volt. 85 [V]</th> <th>Input Volt. 132 [V]</th> </tr> <tr> <th>Ripple Output Volt. [mV]</th> <th>Ripple Output Volt. [mV]</th> </tr> </thead> <tbody> <tr><td>0.00</td><td>10</td><td>5</td></tr> <tr><td>0.40</td><td>10</td><td>5</td></tr> <tr><td>0.80</td><td>10</td><td>10</td></tr> <tr><td>1.20</td><td>10</td><td>10</td></tr> <tr><td>1.60</td><td>15</td><td>10</td></tr> <tr><td>2.00</td><td>15</td><td>15</td></tr> <tr><td>2.40</td><td>15</td><td>15</td></tr> <tr><td>2.80</td><td>25</td><td>15</td></tr> <tr><td>3.00</td><td>30</td><td>20</td></tr> <tr><td>3.30</td><td>40</td><td>25</td></tr> <tr><td>—</td><td>—</td><td>—</td></tr> </tbody> </table>		Load Current [A]	Input Volt. 85 [V]	Input Volt. 132 [V]	Ripple Output Volt. [mV]	Ripple Output Volt. [mV]	0.00	10	5	0.40	10	5	0.80	10	10	1.20	10	10	1.60	15	10	2.00	15	15	2.40	15	15	2.80	25	15	3.00	30	20	3.30	40	25	—	—	—
Load Current [A]	Input Volt. 85 [V]	Input Volt. 132 [V]																																							
	Ripple Output Volt. [mV]	Ripple Output Volt. [mV]																																							
0.00	10	5																																							
0.40	10	5																																							
0.80	10	10																																							
1.20	10	10																																							
1.60	15	10																																							
2.00	15	15																																							
2.40	15	15																																							
2.80	25	15																																							
3.00	30	20																																							
3.30	40	25																																							
—	—	—																																							
<p>Ripple Voltage is shown as p-p in the figure below.</p> <p>Note: Slanted line shows the range of the rated load current.</p> <p>リップル電圧は、下図 p-p 値で示される。 (注)斜線は定格負荷電流範囲を示す。</p> <p>T1: Due to AC Input Line 入力商用周期 T2: Due to Switching スイッチング周期</p>																																									
<p>Fig. Complex Ripple Wave Form 図 リップル波形詳細図</p>																																									



Model		LCA15S-5		Temperature	25°C																																						
Item		Ripple-Noise リップルノイズ		Testing Circuitry	Figure A																																						
Object		+5.0V3A																																									
1. Graph			-----□----- Input Volt. 85V	2. Values																																							
[mV]			-----△----- Input Volt. 132V																																								
			<table border="1"> <thead> <tr> <th rowspan="2">Load current [A]</th> <th>Input Volt. 85 [V]</th> <th>Input Volt. 132 [V]</th> </tr> <tr> <th>Ripple-Noise [mV]</th> <th>Ripple-Noise [mV]</th> </tr> </thead> <tbody> <tr><td>0.00</td><td>15</td><td>10</td></tr> <tr><td>0.40</td><td>15</td><td>10</td></tr> <tr><td>0.80</td><td>15</td><td>15</td></tr> <tr><td>1.20</td><td>15</td><td>15</td></tr> <tr><td>1.60</td><td>20</td><td>15</td></tr> <tr><td>2.00</td><td>20</td><td>15</td></tr> <tr><td>2.40</td><td>20</td><td>15</td></tr> <tr><td>2.80</td><td>30</td><td>15</td></tr> <tr><td>3.00</td><td>40</td><td>25</td></tr> <tr><td>3.30</td><td>50</td><td>30</td></tr> <tr><td>—</td><td>—</td><td>—</td></tr> </tbody> </table>			Load current [A]	Input Volt. 85 [V]	Input Volt. 132 [V]	Ripple-Noise [mV]	Ripple-Noise [mV]	0.00	15	10	0.40	15	10	0.80	15	15	1.20	15	15	1.60	20	15	2.00	20	15	2.40	20	15	2.80	30	15	3.00	40	25	3.30	50	30	—	—	—
Load current [A]	Input Volt. 85 [V]	Input Volt. 132 [V]																																									
	Ripple-Noise [mV]	Ripple-Noise [mV]																																									
0.00	15	10																																									
0.40	15	10																																									
0.80	15	15																																									
1.20	15	15																																									
1.60	20	15																																									
2.00	20	15																																									
2.40	20	15																																									
2.80	30	15																																									
3.00	40	25																																									
3.30	50	30																																									
—	—	—																																									
<p>Ripple-Noise is shown as p-p in the figure below. Note: Slanted line shows the range of the rated load current.</p> <p>リップルノイズは、下図 p-p 値で示される。 (注)斜線は定格負荷電流範囲を示す。</p>																																											
<p>T1: Due to AC Input Line 入力商用周期 T2: Due to Switching スイッチング周期</p>																																											
<p>Fig. Complex Ripple Wave Form 図 リップル波形詳細図</p>																																											

COSEL

Model		LCA15S-5	Temperature		25°C																																																							
Item		Overcurrent Protection 過電流保護	Testing Circuitry		Figure A																																																							
Object		+5.0V3A																																																										
1. Graph			2. Values																																																									
<p>Legend: ——— Input Volt. 85 V ——— Input Volt. 100 V ——— Input Volt. 132 V</p>			<table border="1"> <thead> <tr> <th rowspan="2">Output Voltage [V]</th> <th colspan="3">Load Current [A]</th> </tr> <tr> <th>Input Volt. 85[V]</th> <th>Input Volt. 100[V]</th> <th>Input Volt. 132[V]</th> </tr> </thead> <tbody> <tr><td>5.00</td><td>3.81</td><td>4.18</td><td>4.09</td></tr> <tr><td>4.75</td><td>3.83</td><td>4.16</td><td>4.07</td></tr> <tr><td>4.50</td><td>3.84</td><td>4.15</td><td>4.04</td></tr> <tr><td>4.00</td><td>3.83</td><td>4.10</td><td>3.98</td></tr> <tr><td>3.50</td><td>3.80</td><td>4.03</td><td>3.90</td></tr> <tr><td>3.00</td><td>3.72</td><td>3.92</td><td>3.79</td></tr> <tr><td>2.50</td><td>3.62</td><td>3.79</td><td>3.68</td></tr> <tr><td>2.00</td><td>3.48</td><td>3.62</td><td>3.50</td></tr> <tr><td>1.50</td><td>3.26</td><td>3.37</td><td>3.28</td></tr> <tr><td>1.00</td><td>2.98</td><td>3.08</td><td>3.04</td></tr> <tr><td>0.50</td><td>2.59</td><td>2.65</td><td>2.69</td></tr> <tr><td>0.00</td><td>2.20</td><td>2.25</td><td>2.32</td></tr> </tbody> </table>			Output Voltage [V]	Load Current [A]			Input Volt. 85[V]	Input Volt. 100[V]	Input Volt. 132[V]	5.00	3.81	4.18	4.09	4.75	3.83	4.16	4.07	4.50	3.84	4.15	4.04	4.00	3.83	4.10	3.98	3.50	3.80	4.03	3.90	3.00	3.72	3.92	3.79	2.50	3.62	3.79	3.68	2.00	3.48	3.62	3.50	1.50	3.26	3.37	3.28	1.00	2.98	3.08	3.04	0.50	2.59	2.65	2.69	0.00	2.20	2.25	2.32
Output Voltage [V]	Load Current [A]																																																											
	Input Volt. 85[V]	Input Volt. 100[V]	Input Volt. 132[V]																																																									
5.00	3.81	4.18	4.09																																																									
4.75	3.83	4.16	4.07																																																									
4.50	3.84	4.15	4.04																																																									
4.00	3.83	4.10	3.98																																																									
3.50	3.80	4.03	3.90																																																									
3.00	3.72	3.92	3.79																																																									
2.50	3.62	3.79	3.68																																																									
2.00	3.48	3.62	3.50																																																									
1.50	3.26	3.37	3.28																																																									
1.00	2.98	3.08	3.04																																																									
0.50	2.59	2.65	2.69																																																									
0.00	2.20	2.25	2.32																																																									
<p>Note: Slanted line shows the range of the rated load current.</p> <p>(注)斜線は定格負荷電流範囲を示す。</p>																																																												



Model	LCA15S-5	Temperature	25°C
Item	Inrush Current 突入電流	Testing Circuitry	Figure A
Object	_____		

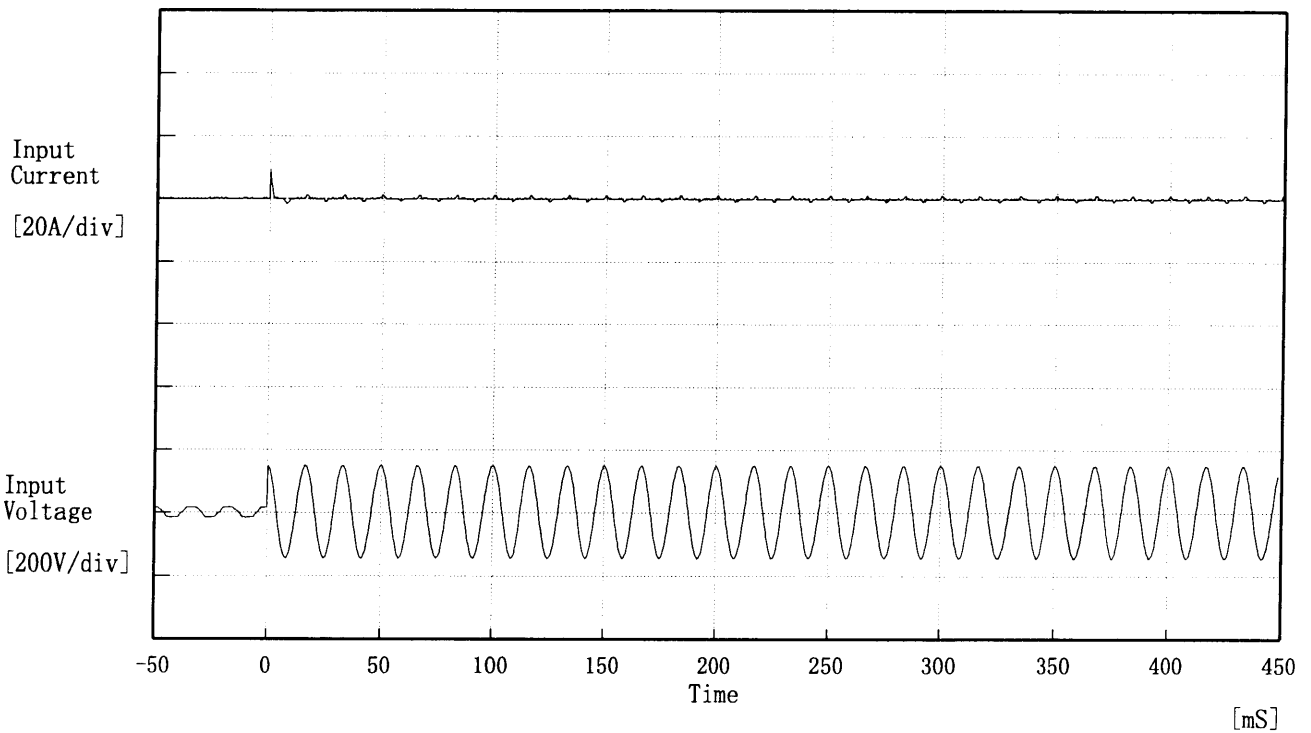

Input Voltage 100 V
 Frequency 60 Hz
 Load 100 %
 Inrush Current
 ① 9.18 [A]
 ② 1.18 [A]

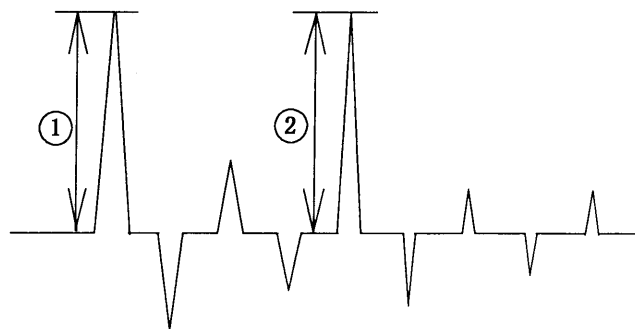

COSEL

Model	LCA15S-5	Temperature	25°C
Item	Dynamic Load Responce 動的負荷変動	Testing Circuitry	Figure A
Object	+5.0V3A		

Input Volt. 100 V
Cycle 1000 mS

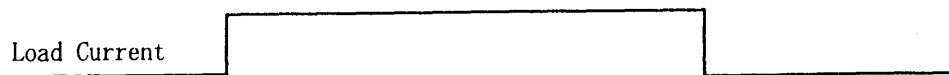

Load 0% ←→
Load 100 %

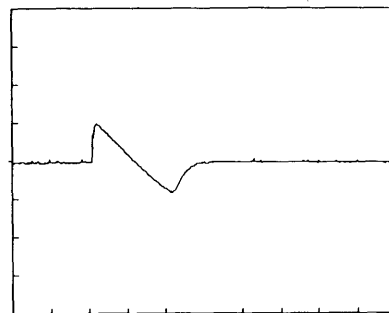
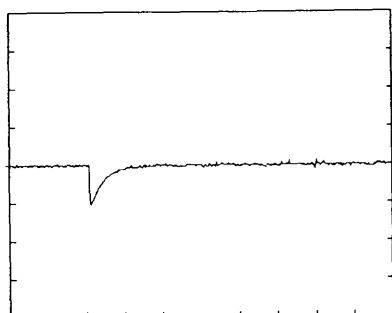

Load 0% ←→
Load 50 %

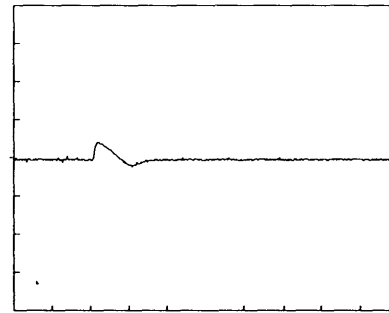
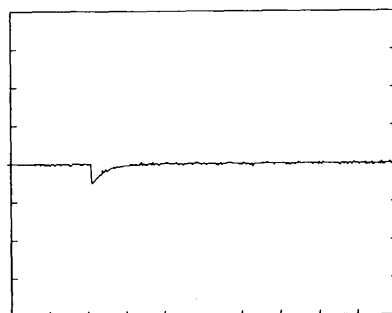

200 mV/div

10 mS/div



Model	LCA15S-5	Temperature	25°C
Item	Rise and Fall Time 立上り、立下り時間	Testing Circuitry	Figure A
Object	+5.0V3A		

1. Graph

Input Volt. 85 V

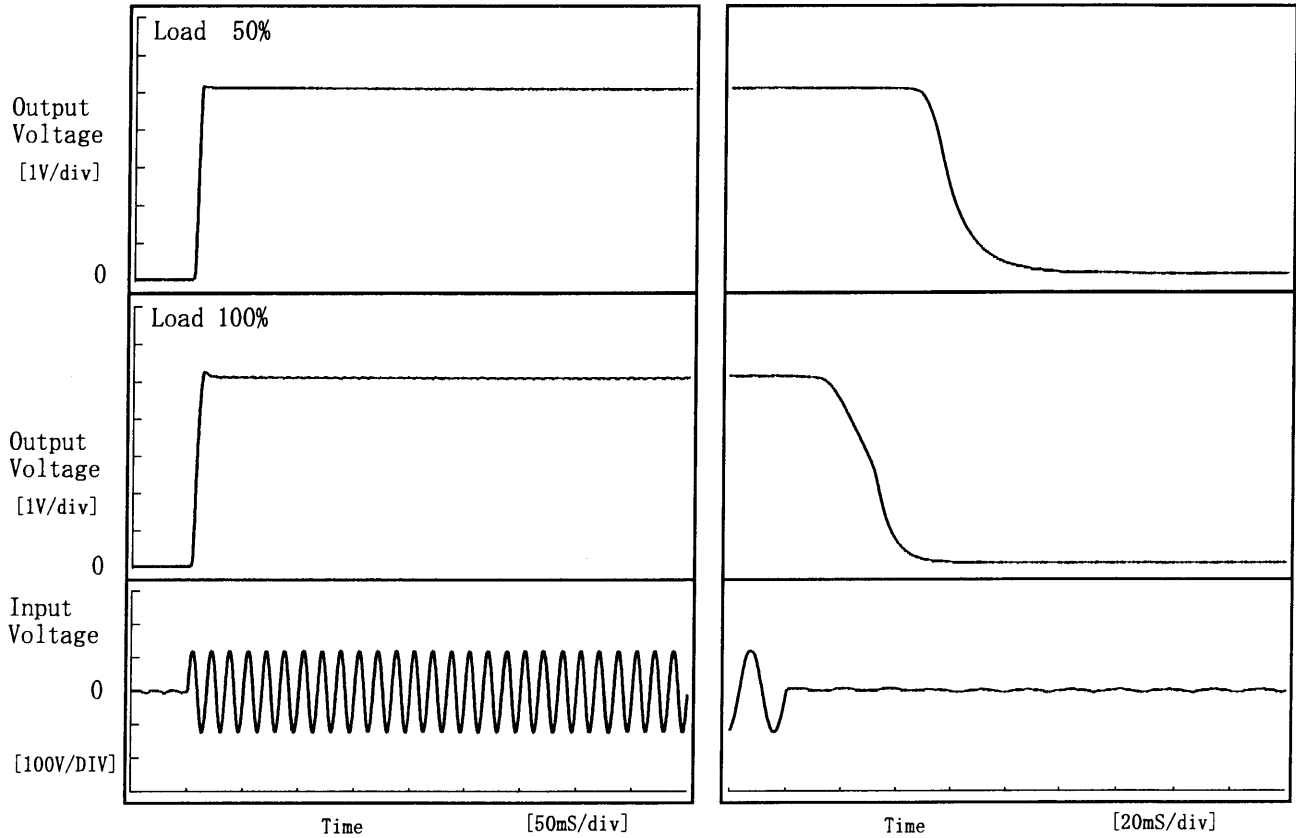

2. Values

[mS]

Load \ Time	T d	T r	T s	T h	T f
50 %	3.5	4.8	8.3	51.5	25.6
100 %	3.8	6.0	9.8	19.3	23.0

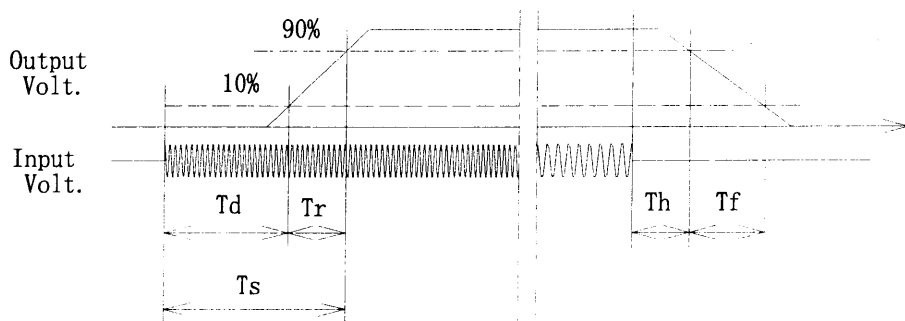



Model		LCA15S-5		Testing Circuitry Figure A																																																				
Item		Ambient Temperature Drift 周囲温度変動																																																						
Object		+5.0V3A																																																						
1. Graph			—△— Input Volt. 85V - - -□- - - Input Volt. 100V - - -○- - - Input Volt. 132V	2. Values																																																				
			<table border="1"> <thead> <tr> <th rowspan="2">Temperature [°C]</th> <th colspan="3">Output Voltage [V]</th> </tr> <tr> <th>Input Volt. 85[V]</th> <th>Input Volt. 100[V]</th> <th>Input Volt. 132[V]</th> </tr> </thead> <tbody> <tr><td>-20</td><td>5.087</td><td>5.088</td><td>5.089</td></tr> <tr><td>-10</td><td>5.089</td><td>5.090</td><td>5.090</td></tr> <tr><td>0</td><td>5.090</td><td>5.091</td><td>5.091</td></tr> <tr><td>10</td><td>5.090</td><td>5.091</td><td>5.091</td></tr> <tr><td>20</td><td>5.090</td><td>5.090</td><td>5.090</td></tr> <tr><td>25</td><td>5.089</td><td>5.089</td><td>5.090</td></tr> <tr><td>30</td><td>5.089</td><td>5.089</td><td>5.089</td></tr> <tr><td>40</td><td>5.087</td><td>5.088</td><td>5.088</td></tr> <tr><td>50</td><td>5.085</td><td>5.086</td><td>5.086</td></tr> <tr><td>60</td><td>5.083</td><td>5.083</td><td>5.083</td></tr> <tr><td>-</td><td>-</td><td>-</td><td>-</td></tr> </tbody> </table>			Temperature [°C]	Output Voltage [V]			Input Volt. 85[V]	Input Volt. 100[V]	Input Volt. 132[V]	-20	5.087	5.088	5.089	-10	5.089	5.090	5.090	0	5.090	5.091	5.091	10	5.090	5.091	5.091	20	5.090	5.090	5.090	25	5.089	5.089	5.090	30	5.089	5.089	5.089	40	5.087	5.088	5.088	50	5.085	5.086	5.086	60	5.083	5.083	5.083	-	-	-	-
Temperature [°C]	Output Voltage [V]																																																							
	Input Volt. 85[V]	Input Volt. 100[V]	Input Volt. 132[V]																																																					
-20	5.087	5.088	5.089																																																					
-10	5.089	5.090	5.090																																																					
0	5.090	5.091	5.091																																																					
10	5.090	5.091	5.091																																																					
20	5.090	5.090	5.090																																																					
25	5.089	5.089	5.090																																																					
30	5.089	5.089	5.089																																																					
40	5.087	5.088	5.088																																																					
50	5.085	5.086	5.086																																																					
60	5.083	5.083	5.083																																																					
-	-	-	-																																																					
Note: Slanted line shows the range of the rated ambient temperature.			Load 100%																																																					
(注) 斜線は定格周囲温度範囲を示す。																																																								



Model	LCA15S-5
Item	Minimum Input Voltage for Regulated Output Voltage 最低レギュレーション電圧
Object	+5.0V3A

Testing Circuitry Figure A

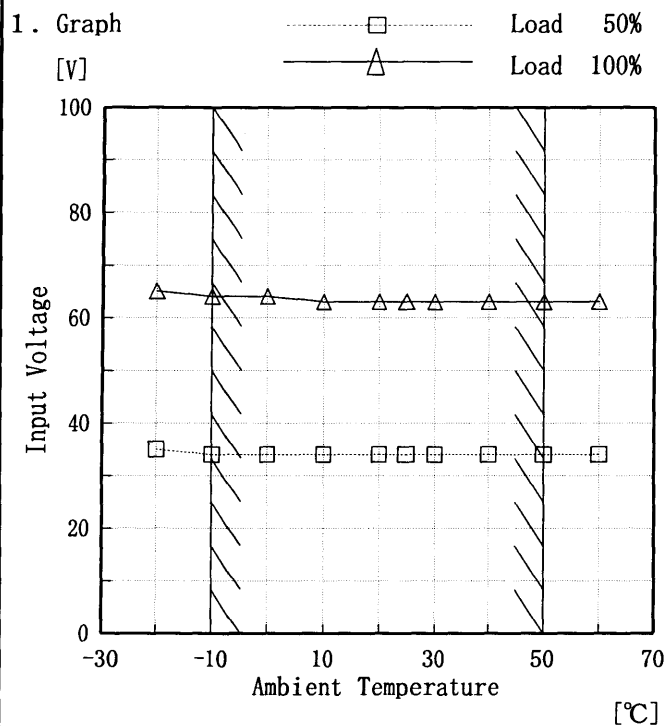

2. Values

Ambient Temperature [°C]	Input Voltage [V]	
	Load 50%	Load 100%
-20	35	65
-10	34	64
0	34	64
10	34	63
20	34	63
25	34	63
30	34	63
40	34	63
50	34	63
60	34	63
—	—	—

Note: Slanted line shows the range of the rated ambient temperature.

(注)斜線は定格周囲温度範囲を示す。



Model	LCA15S-5	Testing Circuitry Figure A
Item	Ripple Voltage (by Ambient Temp.) リップル電圧 (周囲温度特性)	
Object	+5.0V3A	

1. Graph

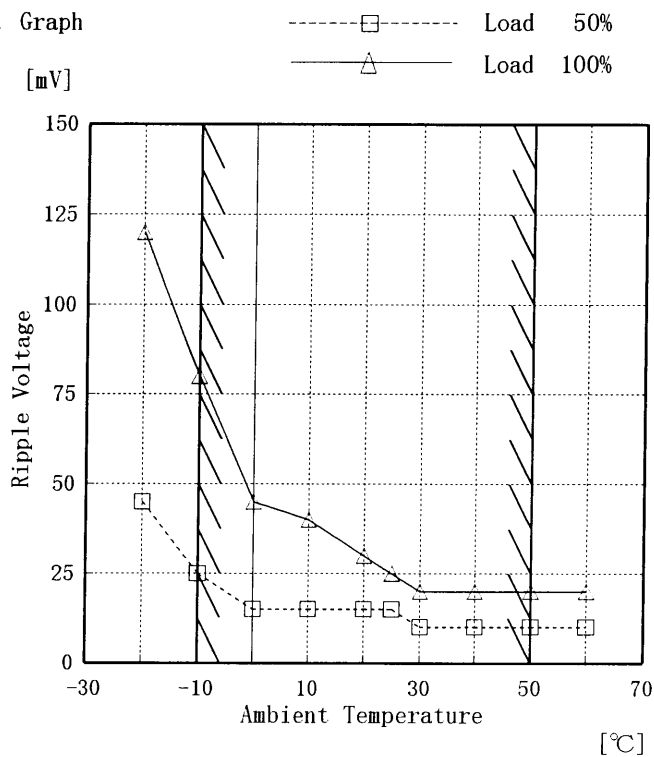

Note: Slanted line shows the range of the rated ambient temperature.

(注)斜線は定格周囲温度範囲を示す。

2. Values

Ambient Temp. [°C]	Load 50%	Load 100%
	Ripple Output Volt. [mV]	Ripple Output Volt. [mV]
-20	45	120
-10	25	80
0	15	45
10	15	40
20	15	30
25	15	25
30	10	20
40	10	20
50	10	20
60	10	20
—	—	—



COSEL																								
Model	LCA15S-5																							
Item	Time Lapse Drift 経時ドリフト	Temperature 25°C Testing Circuitry Figure A																						
Object	+5.0V3A																							
<p>1. Graph</p> <p style="text-align: center;">Time [H]</p> <p style="text-align: center;">Input Volt. 100V Load 100%</p>		<p>2. Values</p> <table border="1"> <thead> <tr> <th>Time since start [H]</th> <th>Output Voltage [V]</th> </tr> </thead> <tbody> <tr><td>0.0</td><td>5.091</td></tr> <tr><td>0.5</td><td>5.090</td></tr> <tr><td>1.0</td><td>5.090</td></tr> <tr><td>2.0</td><td>5.090</td></tr> <tr><td>3.0</td><td>5.090</td></tr> <tr><td>4.0</td><td>5.090</td></tr> <tr><td>5.0</td><td>5.090</td></tr> <tr><td>6.0</td><td>5.090</td></tr> <tr><td>7.0</td><td>5.090</td></tr> <tr><td>8.0</td><td>5.090</td></tr> </tbody> </table>	Time since start [H]	Output Voltage [V]	0.0	5.091	0.5	5.090	1.0	5.090	2.0	5.090	3.0	5.090	4.0	5.090	5.0	5.090	6.0	5.090	7.0	5.090	8.0	5.090
Time since start [H]	Output Voltage [V]																							
0.0	5.091																							
0.5	5.090																							
1.0	5.090																							
2.0	5.090																							
3.0	5.090																							
4.0	5.090																							
5.0	5.090																							
6.0	5.090																							
7.0	5.090																							
8.0	5.090																							



Model		LCA15S-5	Testing Circuitry Figure A
Item		Output Voltage Accuracy 定電圧精度	
Object		+5.0V3A	

Output Voltage Accuracy

This is defined as the value of the output voltage, regulation load, ambient temperature and input voltage varied at random in the range as specified below.

Temperature -10~50 °C

Input Voltage : 85~132 V

Load Current : 0~3 A

* Output Voltage Accuracy = $\pm (\text{Maximum of Output Voltage} - \text{Minimum of Output Voltage}) / 2$

* Output Voltage Accuracy (Ration) = $\frac{\text{Output Voltage Accuracy}}{\text{Rated Output Voltage}} \times 100$

定電圧精度

周囲温度、入力電圧、負荷電流を下記仕様内で、任意に変動させたときの出力電圧の変動をいう。

周囲温度 -10~50 °C

入力電圧 85~132 V

負荷電流 0~3 A

* 定電圧精度(変動値) = $\pm (\text{出力電圧の最高値} - \text{出力電圧の最低値}) / 2$

* 定電圧精度(変動率) = $\frac{\text{変動値}}{\text{定格出力電圧}} \times 100$

Item	Temperature [°C]	Input Voltage [V]	Output Current [A]	Output Voltage [V]	Output Voltage Accuracy [mV]	Output Voltage Accuracy (Ration) [%]
Maximum Voltage	-10	85	0	5.102	±9	±0.2
Minimum Voltage	50	132	3	5.085		



COSEL		
Model	LCA15S-5	
Item	Condensation 結露特性	Testing Circuitry Figure A
Object	+5.0V3A	

1. Condensation test

Testing procedure is as follows.

- ① Keeping and cooling the unit in a tank at -10°C for an hour with the input off.
- ② Taking it out of the tank and dewing itself in a room where the temperature is 25°C and the humidity is 40%RH.
- ③ Testing electrical characteristics of the unit to confirm there be no fault.

1. 結露特性試験

入力を切った状態で、恒温槽で-10℃に冷却しておき、約1時間後に恒温槽から取り出し、室温25℃、湿度40%RHの状態におき結露させ、その電気的特性の測定を行い、異常のないことを確認する。

2. Values

Item	Data	Testing Conditions
Output Voltage [V]	5.092	Input Volt. :100V, Load Current:3A
Line Regulation [mV]	7	Input Volt. :85~132V, Load Current:3A
Load Regulation [mV]	15	Input Volt. :100V, Load Current:0~3A



Model		LCA15S-5	Temperature	25°C
Item		Leakage Current 漏洩電流	Testing Circuitry	Figure B
Object		_____		

1. Results

Standards	Leakage Current [mA]		
	Input Volt. 85 [V]	Input Volt. 100 [V]	Input Volt. 132 [V]
(A) DENTORI	0.08	0.08	0.11
(B) IEC60950	0.08	0.09	0.11

Standards	Leakage Current [mA]		
	Input Volt. 170 [V]	Input Volt. 230 [V]	Input Volt. 264 [V]
(B) IEC60950	—	—	—

2. Condition

Leakage current value is concluded after measuring both phases of AC input and by choosing the larger one.

交流入力 of 両相について測定し、その大きい方を漏洩電流測定値とする。



Model		LCA15S-5	Temperature 25°C Testing Circuitry Figure C
Item		Line Noise Tolerance 入力雑音耐量	
Object		+5.0V3A	

1. Results

Pulse Width [nS]	MODE	No protection failure should occur 保護回路の誤動作がない	DC-like Regulation of Output Voltage 出力電圧の直流的変動
50	COMMON	OK	no fluctuation
	NORMAL	OK	no fluctuation
1000	COMMON	OK	no fluctuation
	NORMAL	OK	no fluctuation

2. Conditions

Input Voltage : 100 V
Pulse Voltage : 2000 V
Pulse Cycle : 10 mS
Pulse Input Duration : 1 min. or more
Load : 100 %



Model	LCA15S-5	Temperature	25°C
Item	Conducted Emission 雑音端子電圧	Testing Circuitry	Figure D
Object	_____		

1. Graph

Remarks

Input Volt. 100 V (VCCI Class B)
 120 V (FCC Class B)
Load 100 %

規格 1: [VCCI] Class B(平均值)
規格 2: [VCCI] Class B(QP)

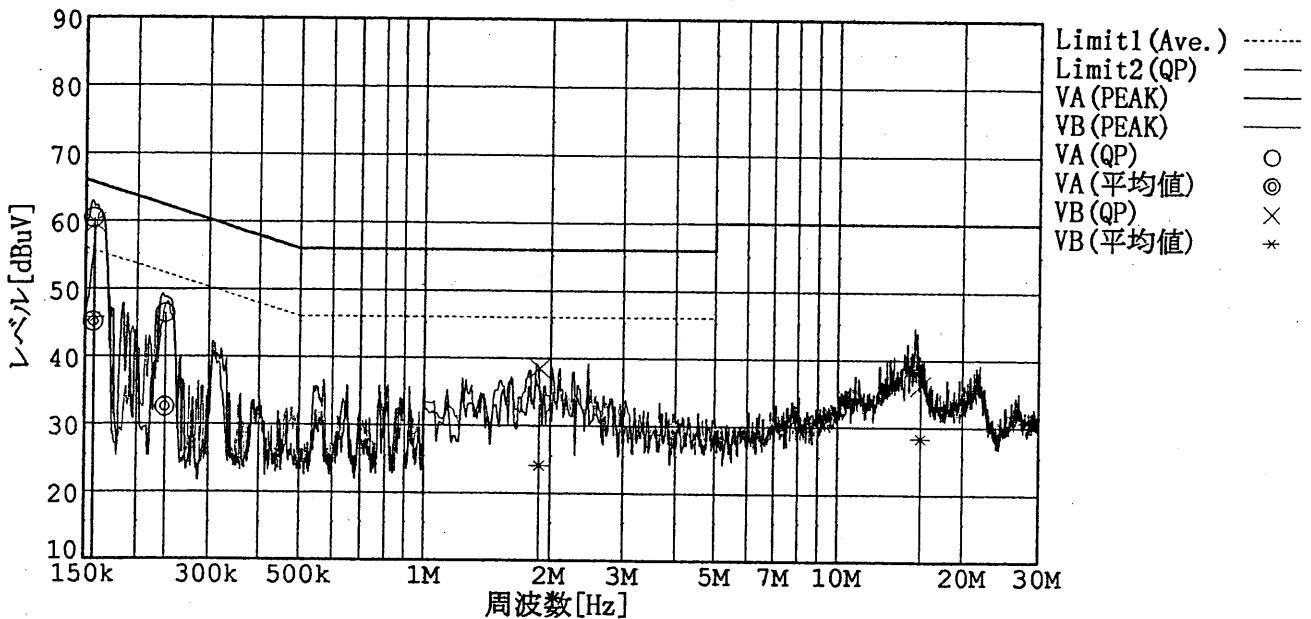

規格 2: [FCC Part15] Class B

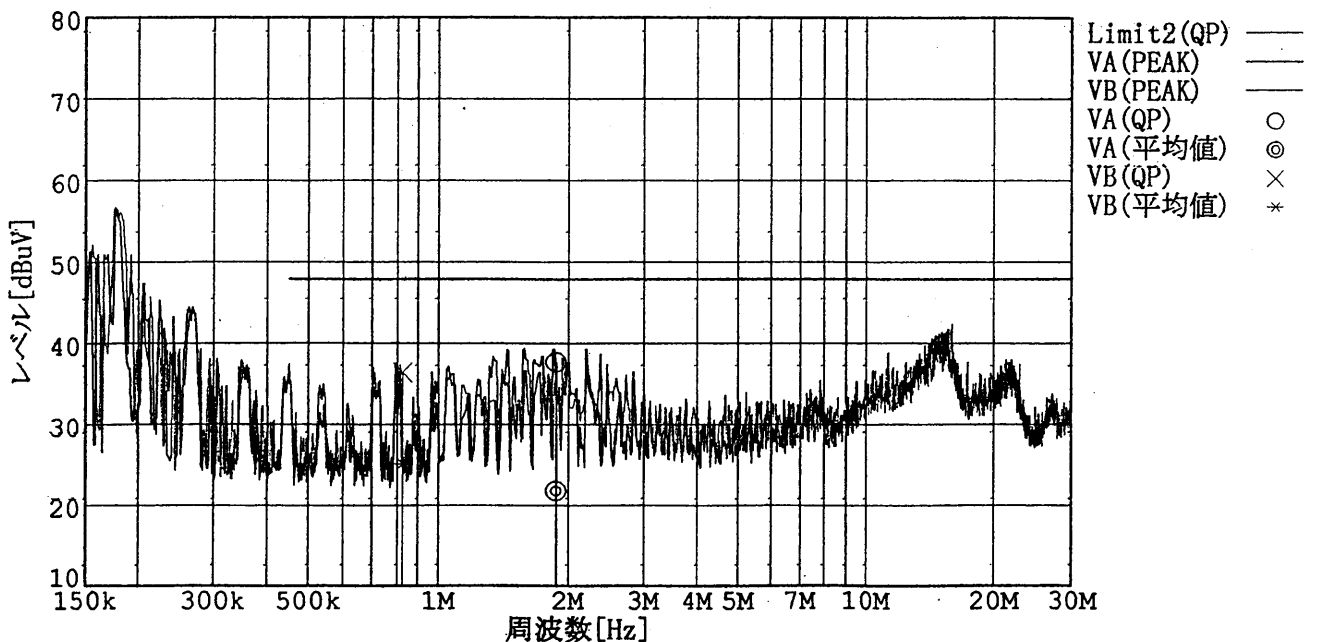

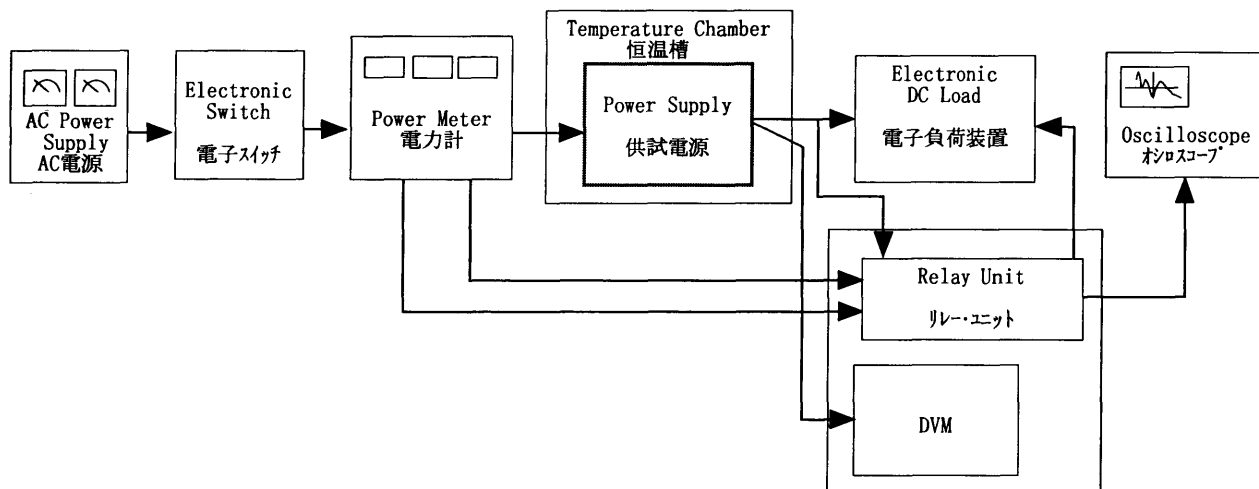

Figure A

Data Acquisition/Control Unit
データ集録システム

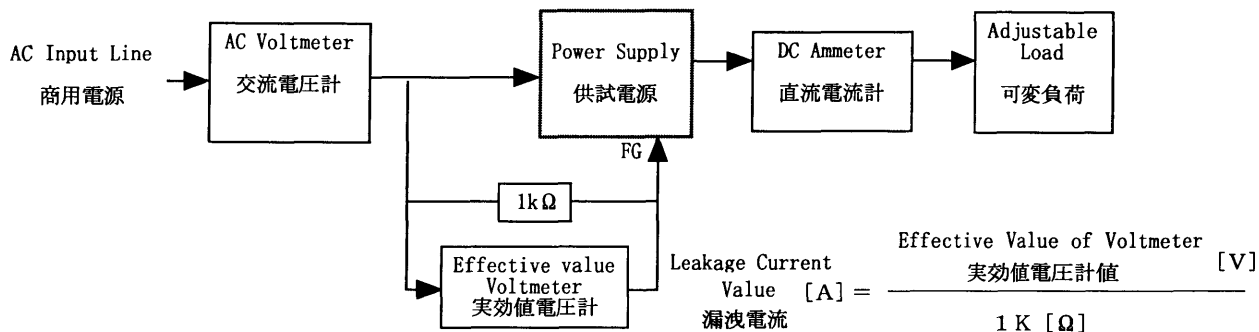

Figure B (DENTORI)

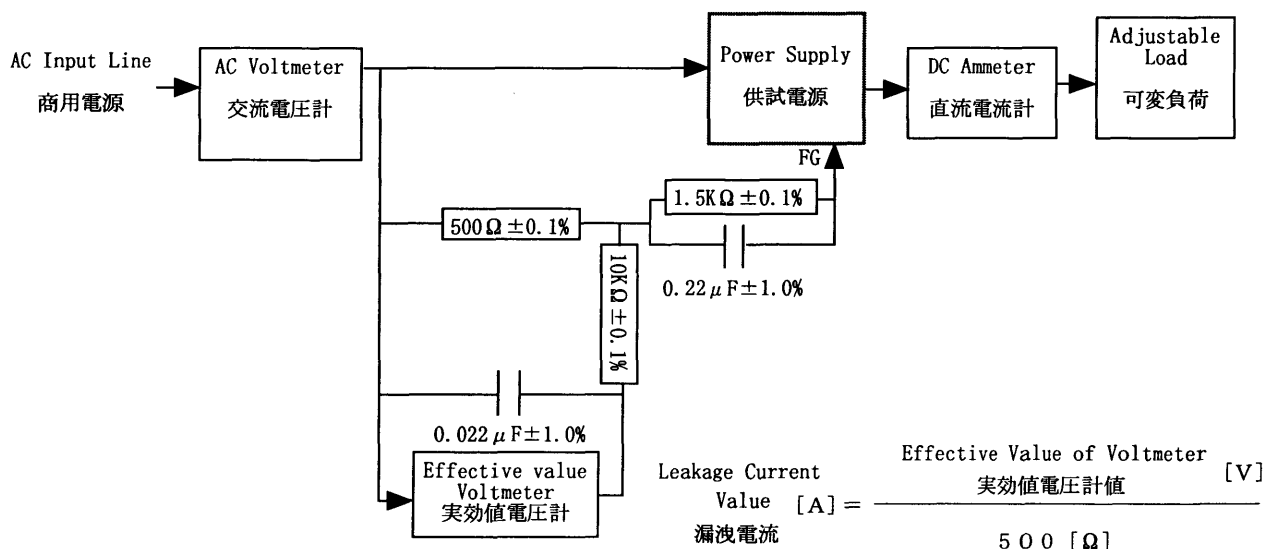

Figure B (I E C 6 0 9 5 0)

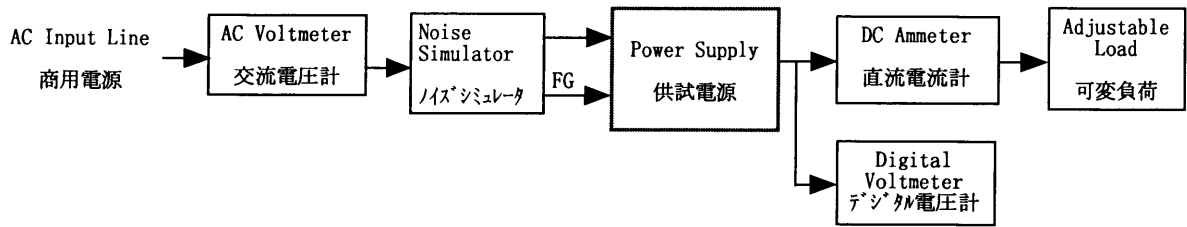

Figure C

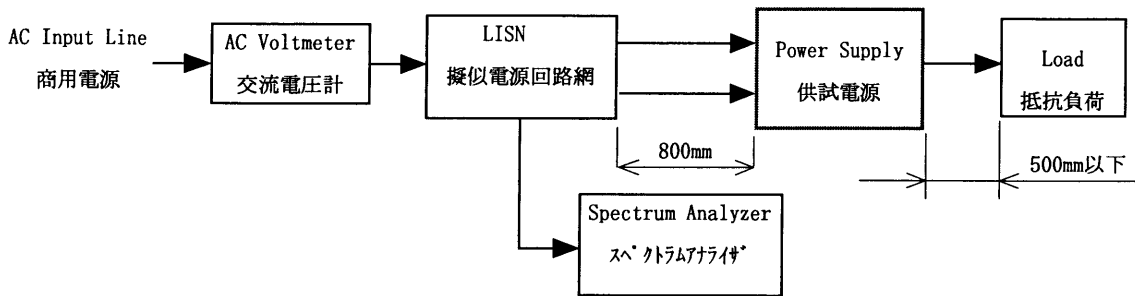

Figure D

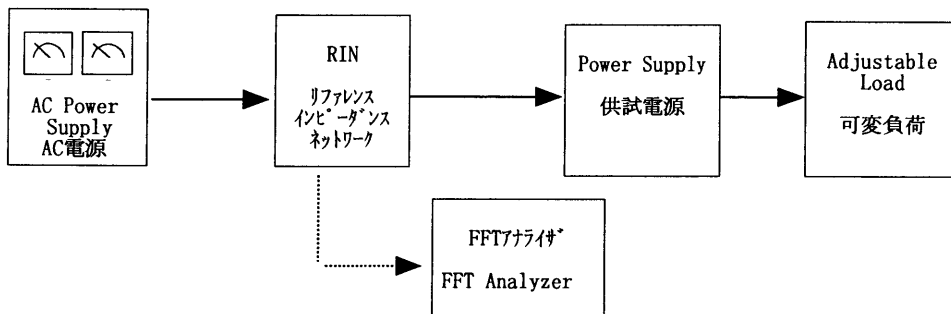

Figure E