

G2W-12 Expected Life : 推定寿命

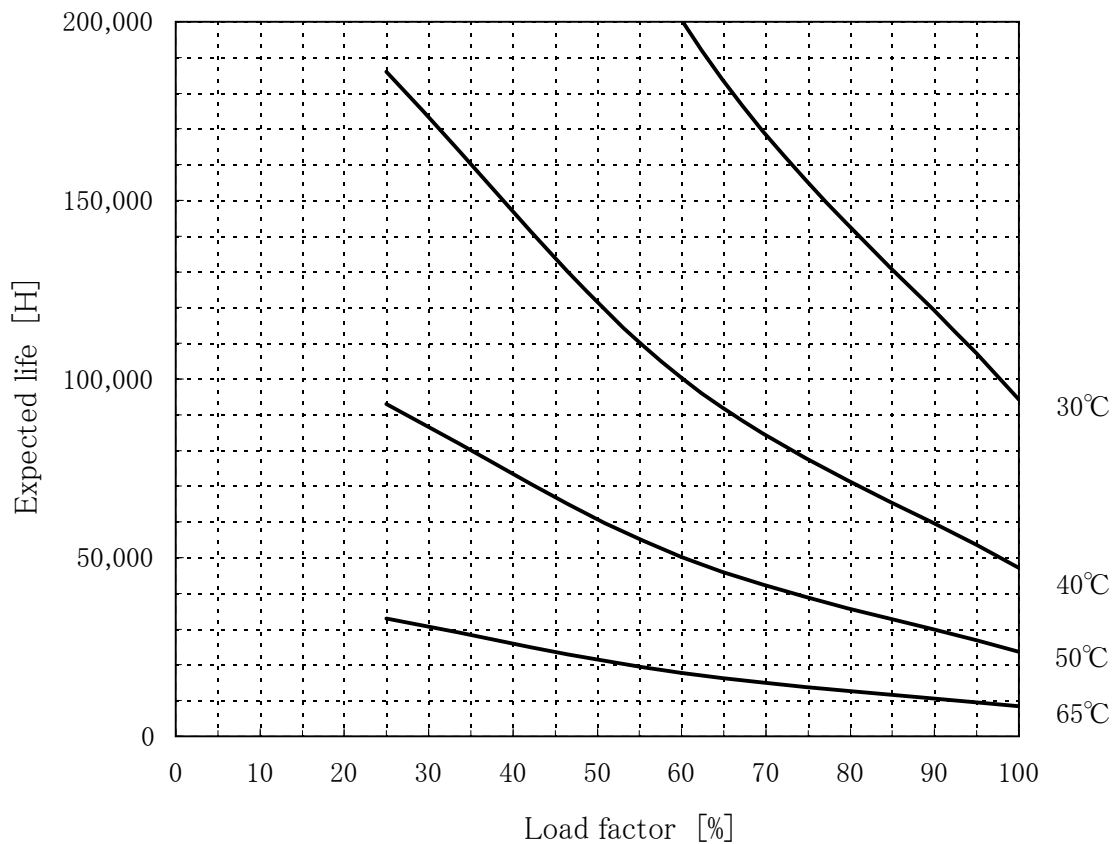

- Above expected life time is calculated according our calculation standard.
上記推定寿命は、当社算出基準に従い算出したものです。
- Over the area of 100,000 hours, the degradation of sealing rubber, etc., is not included in the calculation.
10万時間以上の領域では、封ロゴムの劣化等の影響は、計算式には含まれていません。
- Please refer derating curve shown in instruction manual about the maximum value of ambient temperature.
周囲温度の上限は、取扱説明書のディレーティング表をご参照ください。

Conditions

- (1) Input voltage AC90~110V 60Hz
- (2) Output voltage/current

DC OUTPUT	Load factor			
	100%	75%	50%	25%
12V	0.6A	0.45A	0.3A	0.15A

- (3) Cooling method Convection
- (4) Mounting method Refer below

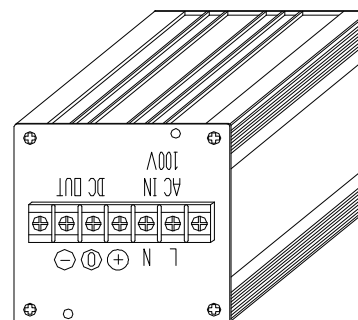

Mounting method(C)