

**TEST DATA OF EAC-20-□□□****Noise Filter**

Feb. 26. 2010

Approved by : Toshio Watanabe  
Toshio Watanabe Design Manager

Prepared by : Tadayuki Noda  
Tadayuki Noda Design Engineer

**COSEL CO.,LTD.**



CONTENTS

1.Attenuation Characteristics ..... 1  
2.Pulse Attenuation Characteristics ..... 4  
3.Leakage Current ..... 6  
4.Figure of Testing Circuitry ..... 7

(Final Page 8)



Model		EAC-20-□□□	Temperature 25°C Testing Circuitry Figure A
Item		Attenuation Characteristics	
Object		_____	

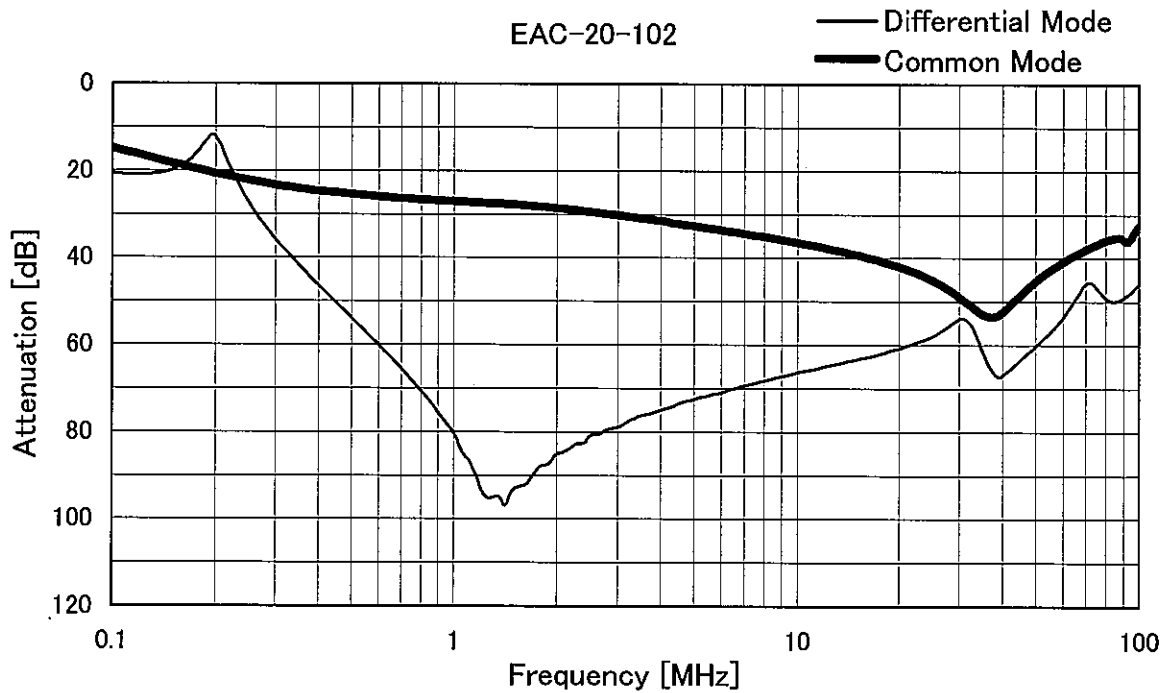
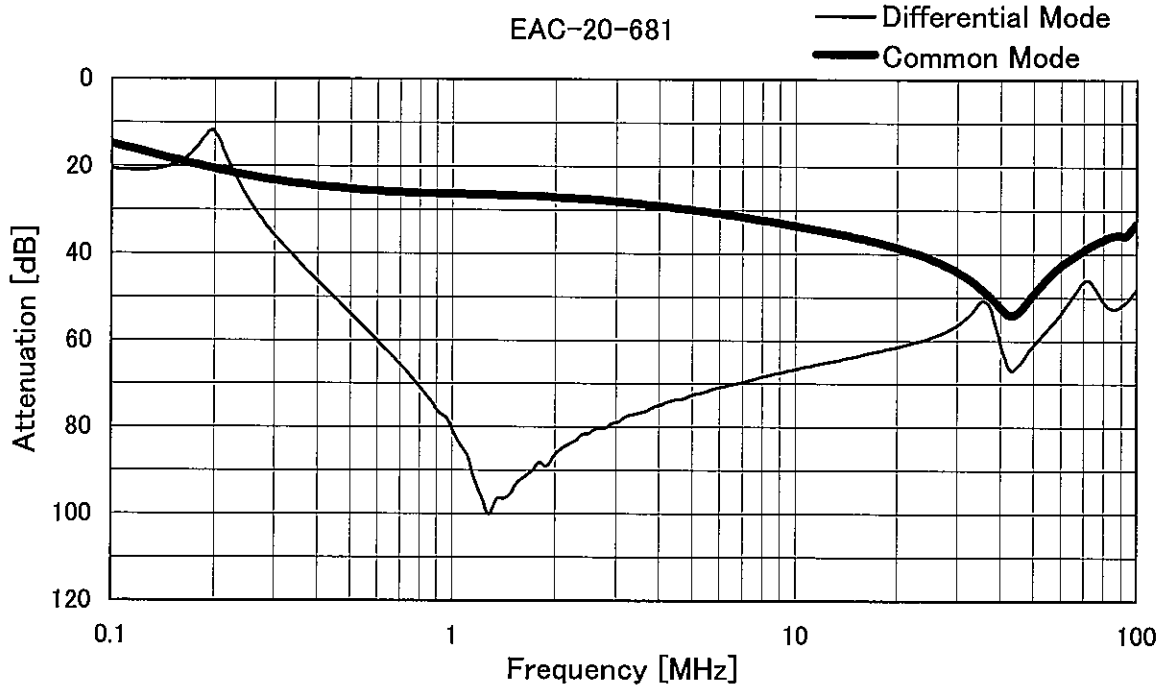



Model		EAC-20-□□□	Temperature 25°C Testing Circuitry Figure A
Item		Attenuation Characteristics	
Object		_____	

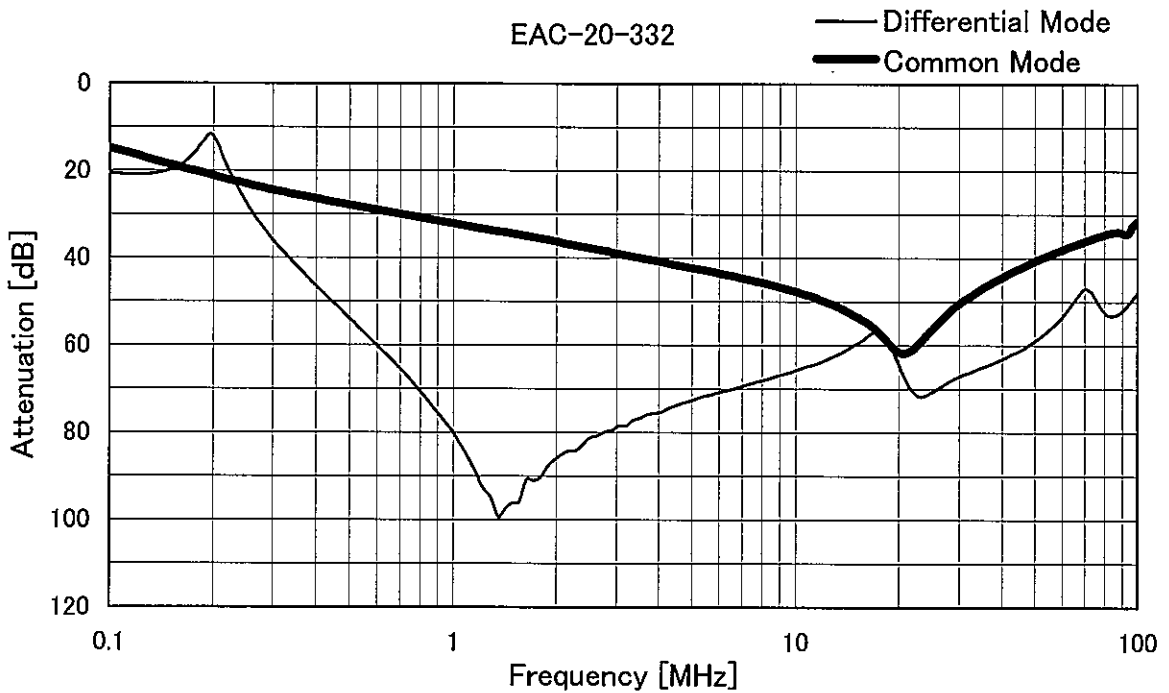
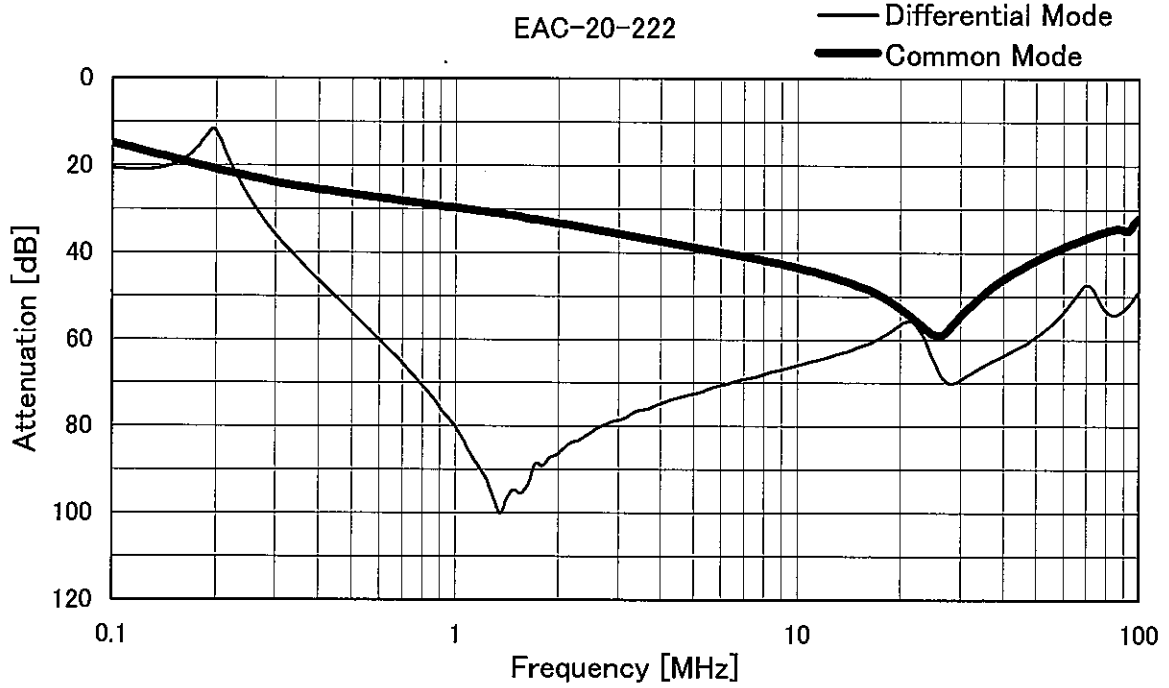



Model		EAC-20-□□□	Temperature 25°C Testing Circuitry Figure A
Item		Attenuation Characteristics	
Object		_____	

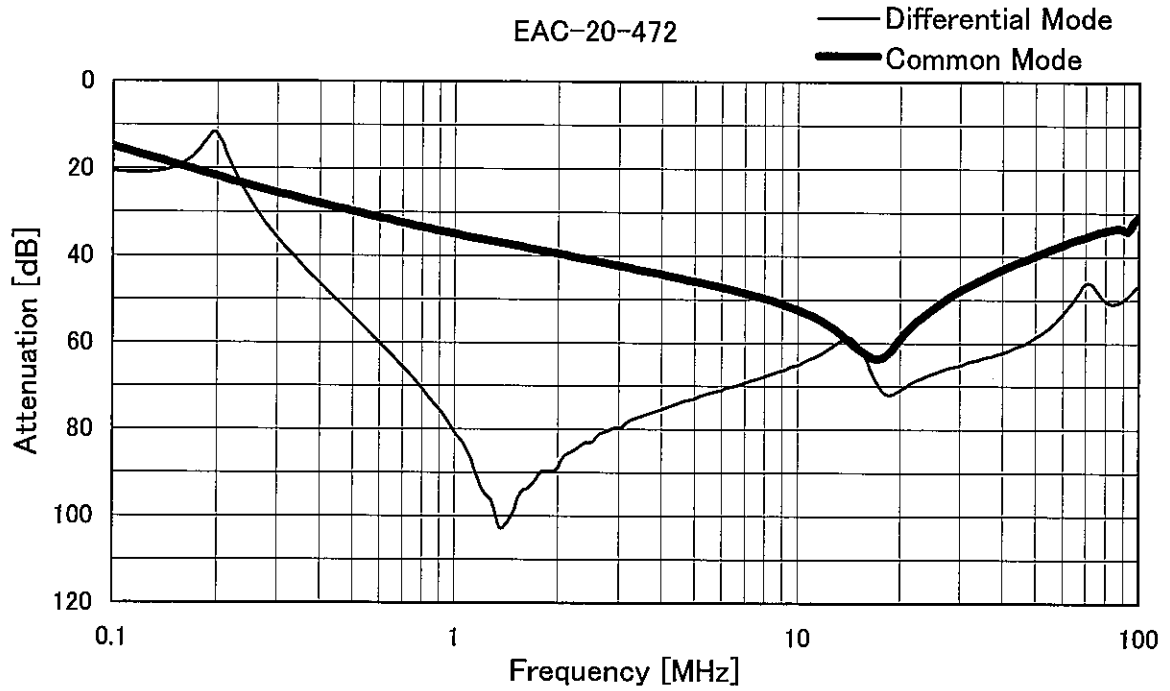



Model	EAC-20-□□□	Temperature	25°C
Item	Pulse Attenuation Characteristics	Testing Circuitry	Figure B
Object	_____		

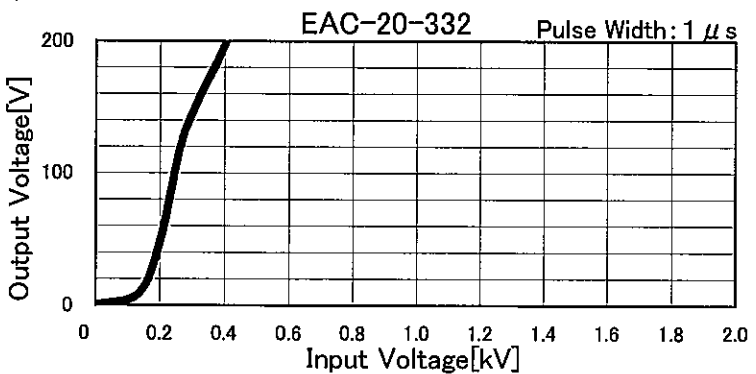
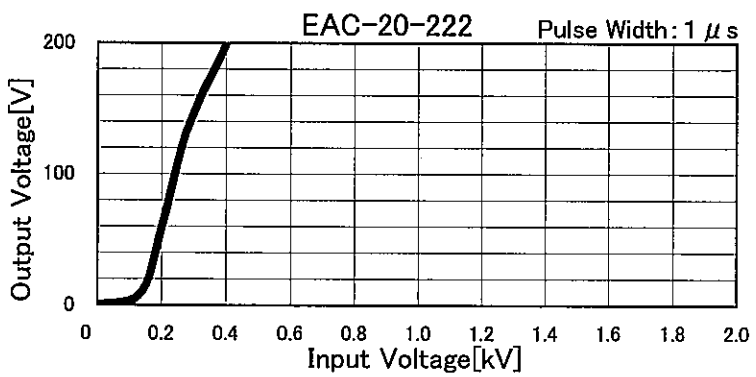
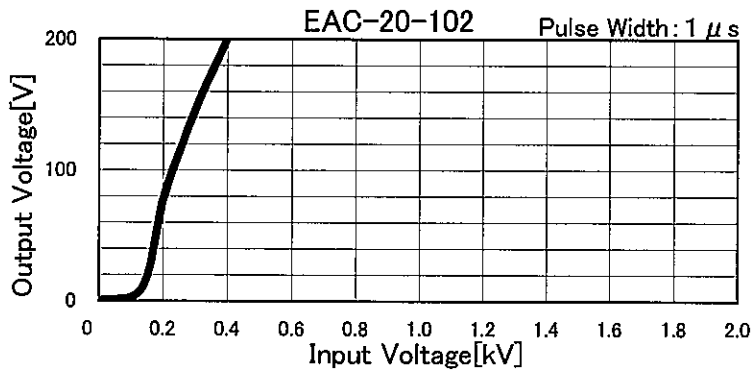
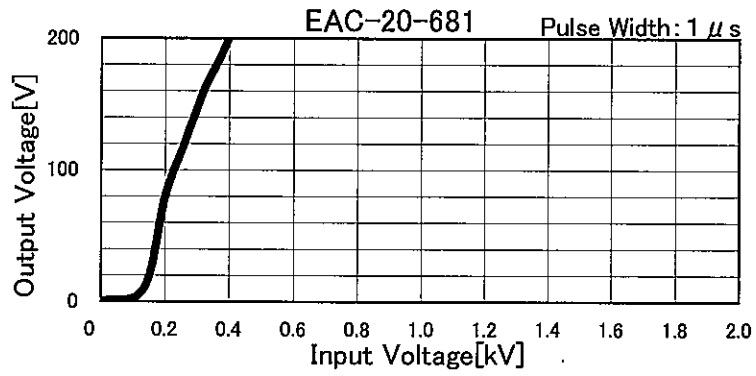



<b>COSEL</b>		
Model	EAC-20-□□□	Temperature 25°C Testing Circuitry Figure B
Item	Pulse Attenuation Characteristics	
Object	_____	

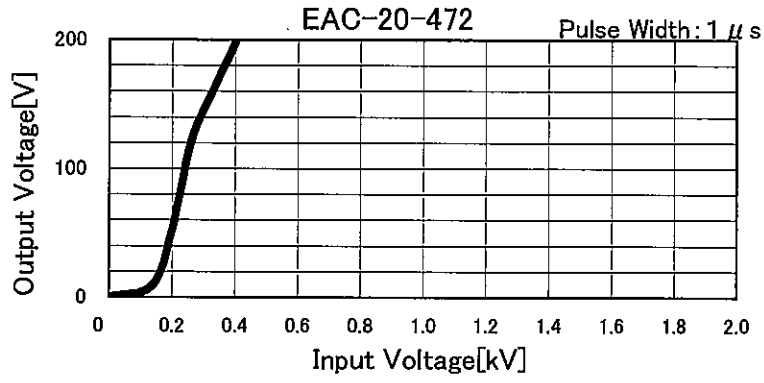



<b>COSEL</b>		Temperature 25°C Testing Circuitry Figure C
Model	EAC-20-□□□	
Item	Leakage Current	
Object	_____	

1.Results

[mA]

Model	Standards	Input Volt.				Note
		100 [V]	125 [V]	230 [V]	250 [V]	
EAC-20-681	UL1283	0.031	0.040	0.082	0.093	
EAC-20-102	UL1283	0.044	0.056	0.110	0.120	
EAC-20-222	UL1283	0.090	0.120	0.230	0.250	
EAC-20-332	UL1283	0.130	0.170	0.340	0.370	
EAC-20-472	UL1283	0.190	0.240	0.480	0.520	

2.Condition

Leakage current value is concluded after measuring both phases of AC input and by choosing the larger one.



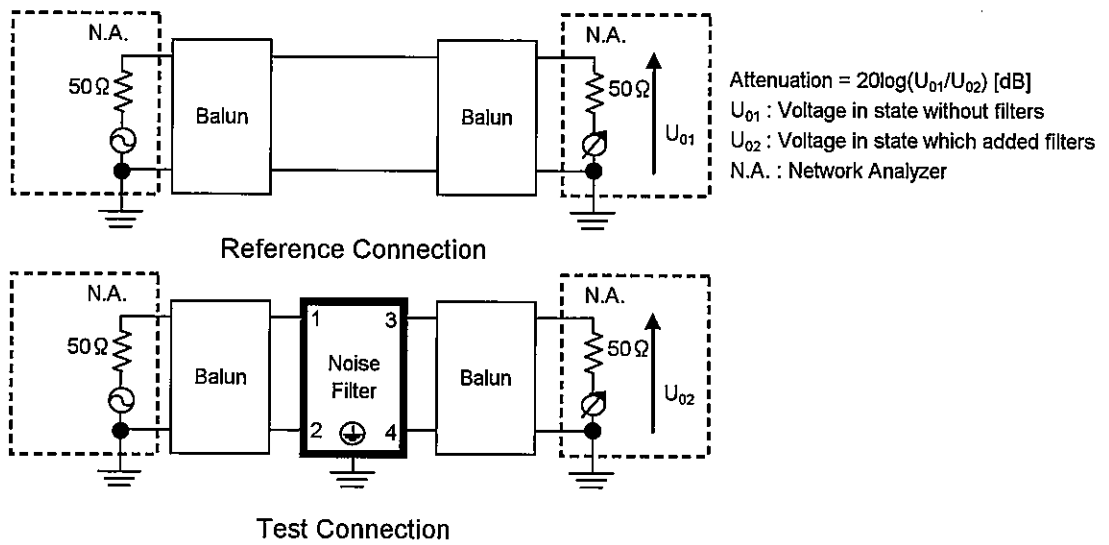

Figure A - 1 Differential mode attenuation measurement

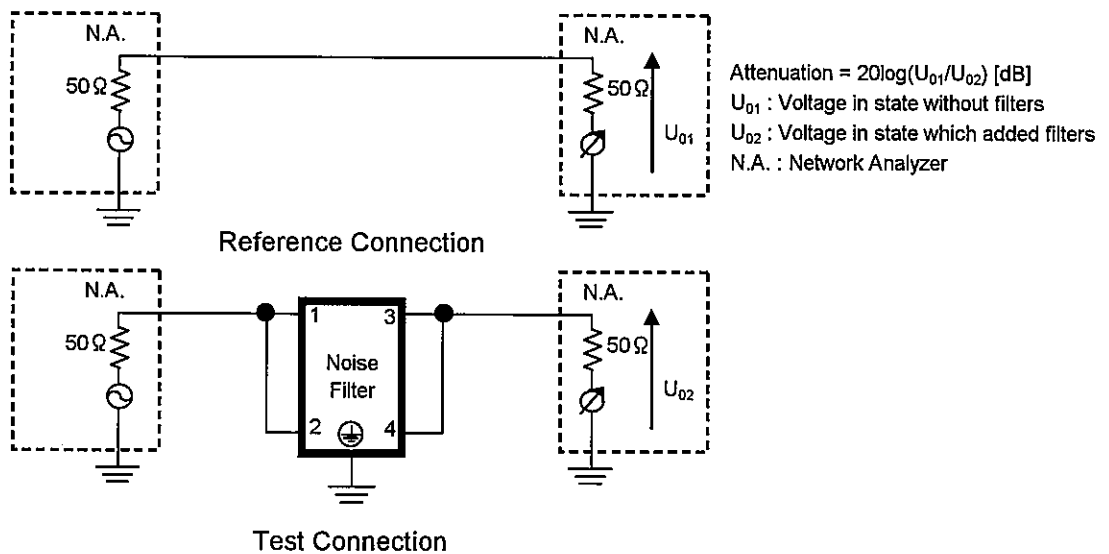
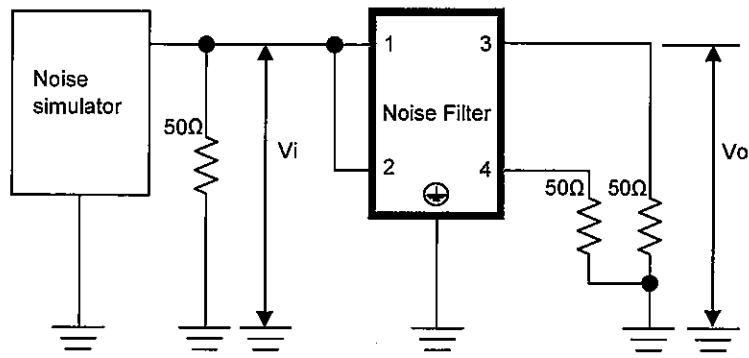

Figure A - 2 Common mode attenuation measurement



Pulse attenuation measurement

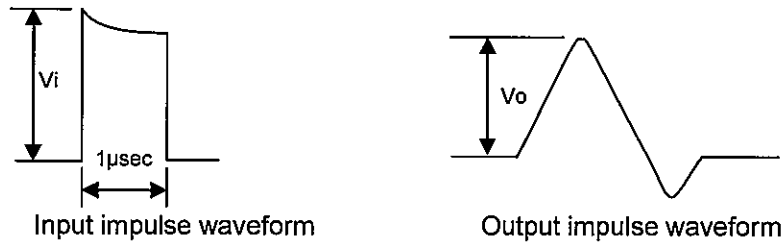

Figure B Pulse attenuation measurement

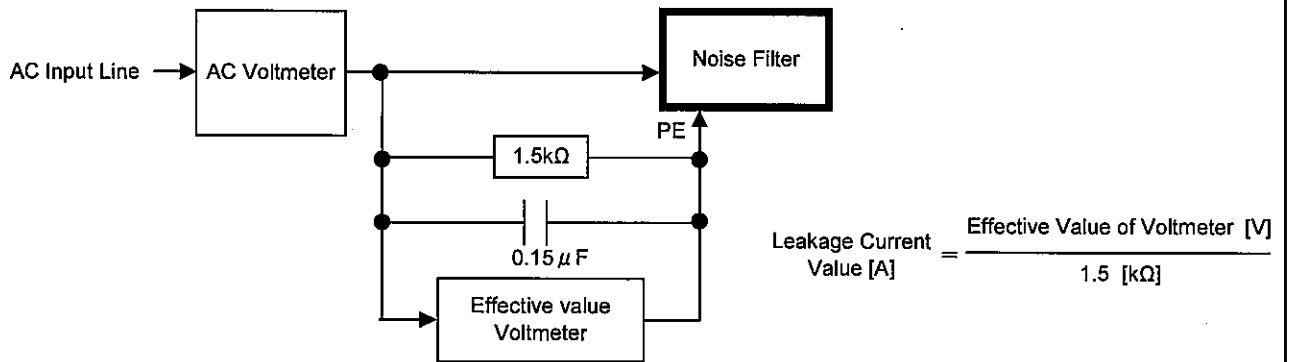

Figure C Leakage current measurement ( UL1283 )