

# TEST DATA OF CES24050-16

Regulated DC Power Supply  
Aug 10, 2007

Approved by : Tatsuya Mano  
Tatsuya Mano Design Manager

Prepared by : Masahiro Miyake  
Masahiro Miyake Design Engineer

**COSEL CO.,LTD.**

## CONTENTS

1.Input Current (by Input Voltage) . . . . .	1
2.Input Current (by Load Current) . . . . .	2
3.Input Power (by Load Current) . . . . .	3
4.Efficiency (by Input Voltage) . . . . .	4
5.Efficiency (by Load Current) . . . . .	5
6.Line Regulation . . . . .	6
7.Load Regulation . . . . .	7
8.Dynamic Load Response . . . . .	8
9.Ripple Voltage (by Load Current) . . . . .	9
10.Ripple-Noise . . . . .	10
11.Ripple Voltage (by Ambient Temperature) . . . . .	11
12.Ambient Temperature Drift . . . . .	12
13.Output Voltage Accuracy . . . . .	13
14.Time Lapse Drift . . . . .	14
15.Rise and Fall Time . . . . .	15
16.Minimum Input Voltage for Regulated Output Voltage . . . . .	16
17.Overcurrent Protection . . . . .	17
18.Overtoltage Protection . . . . .	18
19.Figure of Testing Circuitry . . . . .	19

(Final Page 19)



Model		CES24050-16		Temperature		25°C																																																																																
Item		Input Current (by Input Voltage)		Testing Circuitry		Figure A																																																																																
Object		_____																																																																																				
1.Graph				2.Values																																																																																		
				<table border="1"> <thead> <tr> <th rowspan="2">Input Voltage [V]</th> <th colspan="3">Input Current [A]</th> </tr> <tr> <th>Load 0%</th> <th>Load 50%</th> <th>Load 100%</th> </tr> </thead> <tbody> <tr><td>0.0</td><td>0.000</td><td>0.000</td><td>0.000</td></tr> <tr><td>4.0</td><td>0.000</td><td>0.000</td><td>0.000</td></tr> <tr><td>8.0</td><td>0.000</td><td>0.000</td><td>0.000</td></tr> <tr><td>12.0</td><td>0.000</td><td>0.000</td><td>0.000</td></tr> <tr><td>16.0</td><td>0.000</td><td>0.000</td><td>0.000</td></tr> <tr><td>16.6</td><td>0.118</td><td>2.640</td><td>5.330</td></tr> <tr><td>18.0</td><td>0.101</td><td>2.408</td><td>4.860</td></tr> <tr><td>20.0</td><td>0.092</td><td>2.154</td><td>4.358</td></tr> <tr><td>24.0</td><td>0.085</td><td>1.818</td><td>3.638</td></tr> <tr><td>28.0</td><td>0.083</td><td>1.558</td><td>3.118</td></tr> <tr><td>32.0</td><td>0.080</td><td>1.371</td><td>2.729</td></tr> <tr><td>36.0</td><td>0.077</td><td>1.234</td><td>2.448</td></tr> <tr><td>40.0</td><td>0.076</td><td>1.115</td><td>2.200</td></tr> <tr><td>--</td><td>-</td><td>-</td><td>-</td></tr> <tr><td>--</td><td>-</td><td>-</td><td>-</td></tr> <tr><td>--</td><td>-</td><td>-</td><td>-</td></tr> <tr><td>--</td><td>-</td><td>-</td><td>-</td></tr> <tr><td>--</td><td>-</td><td>-</td><td>-</td></tr> </tbody> </table>				Input Voltage [V]	Input Current [A]			Load 0%	Load 50%	Load 100%	0.0	0.000	0.000	0.000	4.0	0.000	0.000	0.000	8.0	0.000	0.000	0.000	12.0	0.000	0.000	0.000	16.0	0.000	0.000	0.000	16.6	0.118	2.640	5.330	18.0	0.101	2.408	4.860	20.0	0.092	2.154	4.358	24.0	0.085	1.818	3.638	28.0	0.083	1.558	3.118	32.0	0.080	1.371	2.729	36.0	0.077	1.234	2.448	40.0	0.076	1.115	2.200	--	-	-	-	--	-	-	-	--	-	-	-	--	-	-	-	--	-	-	-
Input Voltage [V]	Input Current [A]																																																																																					
	Load 0%	Load 50%	Load 100%																																																																																			
0.0	0.000	0.000	0.000																																																																																			
4.0	0.000	0.000	0.000																																																																																			
8.0	0.000	0.000	0.000																																																																																			
12.0	0.000	0.000	0.000																																																																																			
16.0	0.000	0.000	0.000																																																																																			
16.6	0.118	2.640	5.330																																																																																			
18.0	0.101	2.408	4.860																																																																																			
20.0	0.092	2.154	4.358																																																																																			
24.0	0.085	1.818	3.638																																																																																			
28.0	0.083	1.558	3.118																																																																																			
32.0	0.080	1.371	2.729																																																																																			
36.0	0.077	1.234	2.448																																																																																			
40.0	0.076	1.115	2.200																																																																																			
--	-	-	-																																																																																			
--	-	-	-																																																																																			
--	-	-	-																																																																																			
--	-	-	-																																																																																			
--	-	-	-																																																																																			
<p>Note: Slanted line shows the range of the rated input voltage.</p>																																																																																						



Model		CES24050-16		Temperature 25°C																																																				
Item		Input Current (by Load Current)		Testing Circuitry Figure A																																																				
Object		_____																																																						
1.Graph		—△— Input Volt. 18V - - - □ - - Input Volt. 24V - - - ○ - - Input Volt. 36V		2.Values																																																				
				<table border="1"> <thead> <tr> <th rowspan="2">Load Current [A]</th> <th colspan="3">Input Current [A]</th> </tr> <tr> <th>Input Volt. 18[V]</th> <th>Input Volt. 24[V]</th> <th>Input Volt. 36[V]</th> </tr> </thead> <tbody> <tr><td>0.0</td><td>0.101</td><td>0.085</td><td>0.077</td></tr> <tr><td>2.0</td><td>0.669</td><td>0.509</td><td>0.360</td></tr> <tr><td>4.0</td><td>1.241</td><td>0.943</td><td>0.650</td></tr> <tr><td>6.0</td><td>1.825</td><td>1.381</td><td>0.942</td></tr> <tr><td>8.0</td><td>2.408</td><td>1.818</td><td>1.234</td></tr> <tr><td>10.0</td><td>2.998</td><td>2.258</td><td>1.530</td></tr> <tr><td>12.0</td><td>3.616</td><td>2.716</td><td>1.836</td></tr> <tr><td>14.0</td><td>4.214</td><td>3.176</td><td>2.140</td></tr> <tr><td>16.0</td><td>4.860</td><td>3.638</td><td>2.448</td></tr> <tr><td>17.6</td><td>5.370</td><td>4.024</td><td>2.692</td></tr> <tr><td>--</td><td>-</td><td>-</td><td>-</td></tr> </tbody> </table>		Load Current [A]	Input Current [A]			Input Volt. 18[V]	Input Volt. 24[V]	Input Volt. 36[V]	0.0	0.101	0.085	0.077	2.0	0.669	0.509	0.360	4.0	1.241	0.943	0.650	6.0	1.825	1.381	0.942	8.0	2.408	1.818	1.234	10.0	2.998	2.258	1.530	12.0	3.616	2.716	1.836	14.0	4.214	3.176	2.140	16.0	4.860	3.638	2.448	17.6	5.370	4.024	2.692	--	-	-	-
Load Current [A]	Input Current [A]																																																							
	Input Volt. 18[V]	Input Volt. 24[V]	Input Volt. 36[V]																																																					
0.0	0.101	0.085	0.077																																																					
2.0	0.669	0.509	0.360																																																					
4.0	1.241	0.943	0.650																																																					
6.0	1.825	1.381	0.942																																																					
8.0	2.408	1.818	1.234																																																					
10.0	2.998	2.258	1.530																																																					
12.0	3.616	2.716	1.836																																																					
14.0	4.214	3.176	2.140																																																					
16.0	4.860	3.638	2.448																																																					
17.6	5.370	4.024	2.692																																																					
--	-	-	-																																																					
Note: Slanted line shows the range of the rated load current.																																																								



Model		CES24050-16	Temperature		25°C																																																			
Item		Input Power (by Load Current)	Testing Circuitry		Figure A																																																			
Object																																																								
1. Graph		<p>—△— Input Volt. 18V</p> <p>---□--- Input Volt. 24V</p> <p>-·-○-·- Input Volt. 36V</p>	2. Values																																																					
		<table border="1"> <thead> <tr> <th rowspan="2">Load Current [A]</th> <th colspan="3">Input Power [W]</th> </tr> <tr> <th>Input Volt. 18[V]</th> <th>Input Volt. 24[V]</th> <th>Input Volt. 36[V]</th> </tr> </thead> <tbody> <tr><td>0.0</td><td>1.84</td><td>2.09</td><td>2.79</td></tr> <tr><td>2.0</td><td>12.07</td><td>12.22</td><td>12.99</td></tr> <tr><td>4.0</td><td>22.41</td><td>22.64</td><td>23.53</td></tr> <tr><td>6.0</td><td>32.96</td><td>33.17</td><td>34.02</td></tr> <tr><td>8.0</td><td>43.50</td><td>43.70</td><td>44.50</td></tr> <tr><td>10.0</td><td>54.20</td><td>54.40</td><td>55.20</td></tr> <tr><td>12.0</td><td>65.20</td><td>65.30</td><td>66.30</td></tr> <tr><td>14.0</td><td>76.30</td><td>76.20</td><td>77.10</td></tr> <tr><td>16.0</td><td>87.90</td><td>87.60</td><td>88.30</td></tr> <tr><td>17.6</td><td>97.10</td><td>96.80</td><td>97.40</td></tr> <tr><td>--</td><td>-</td><td>-</td><td>-</td></tr> </tbody> </table>				Load Current [A]	Input Power [W]			Input Volt. 18[V]	Input Volt. 24[V]	Input Volt. 36[V]	0.0	1.84	2.09	2.79	2.0	12.07	12.22	12.99	4.0	22.41	22.64	23.53	6.0	32.96	33.17	34.02	8.0	43.50	43.70	44.50	10.0	54.20	54.40	55.20	12.0	65.20	65.30	66.30	14.0	76.30	76.20	77.10	16.0	87.90	87.60	88.30	17.6	97.10	96.80	97.40	--	-	-	-
Load Current [A]	Input Power [W]																																																							
	Input Volt. 18[V]	Input Volt. 24[V]	Input Volt. 36[V]																																																					
0.0	1.84	2.09	2.79																																																					
2.0	12.07	12.22	12.99																																																					
4.0	22.41	22.64	23.53																																																					
6.0	32.96	33.17	34.02																																																					
8.0	43.50	43.70	44.50																																																					
10.0	54.20	54.40	55.20																																																					
12.0	65.20	65.30	66.30																																																					
14.0	76.30	76.20	77.10																																																					
16.0	87.90	87.60	88.30																																																					
17.6	97.10	96.80	97.40																																																					
--	-	-	-																																																					
<p>Note: Slanted line shows the range of the rated load current.</p>																																																								



<p><b>Model</b> CES24050-16</p>		<p>Temperature 25°C Testing Circuitry Figure A</p>																																
<p><b>Item</b> Efficiency (by Input Voltage)</p>																																		
<p><b>Object</b> _____</p>																																		
<p>1. Graph</p> <p>---□--- Load 50% —△— Load 100%</p> <p>Efficiency [%]</p> <p>Input Voltage [V]</p> <p>Note: Slanted line shows the range of the rated input voltage.</p>		<p>2. Values</p> <table border="1"> <thead> <tr> <th rowspan="2">Input Voltage [V]</th> <th colspan="2">Efficiency [%]</th> </tr> <tr> <th>Load 50%</th> <th>Load 100%</th> </tr> </thead> <tbody> <tr> <td>17</td> <td>91.5</td> <td>90.4</td> </tr> <tr> <td>18</td> <td>91.8</td> <td>90.6</td> </tr> <tr> <td>20</td> <td>91.7</td> <td>90.9</td> </tr> <tr> <td>24</td> <td>91.3</td> <td>91.0</td> </tr> <tr> <td>30</td> <td>90.7</td> <td>90.7</td> </tr> <tr> <td>36</td> <td>89.7</td> <td>90.2</td> </tr> <tr> <td>40</td> <td>88.9</td> <td>89.8</td> </tr> <tr> <td>--</td> <td>-</td> <td>-</td> </tr> <tr> <td>--</td> <td>-</td> <td>-</td> </tr> </tbody> </table>	Input Voltage [V]	Efficiency [%]		Load 50%	Load 100%	17	91.5	90.4	18	91.8	90.6	20	91.7	90.9	24	91.3	91.0	30	90.7	90.7	36	89.7	90.2	40	88.9	89.8	--	-	-	--	-	-
Input Voltage [V]	Efficiency [%]																																	
	Load 50%	Load 100%																																
17	91.5	90.4																																
18	91.8	90.6																																
20	91.7	90.9																																
24	91.3	91.0																																
30	90.7	90.7																																
36	89.7	90.2																																
40	88.9	89.8																																
--	-	-																																
--	-	-																																



Model	CES24050-16
Item	Efficiency (by Load Current)
Object	_____

Temperature 25°C  
Testing Circuitry Figure A

1.Graph

- △— Input Volt. 18V
- - -□- - Input Volt. 24V
- · -○- · - Input Volt. 36V

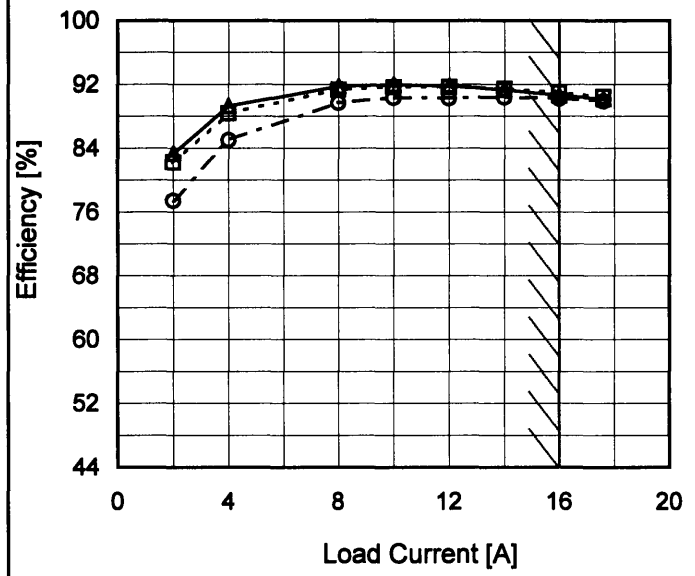

Note: Slanted line shows the range of the rated load current.

2.Values

Load Current [A]	Efficiency [%]		
	Input Volt. 18[V]	Input Volt. 24[V]	Input Volt. 36[V]
0.0	-	-	-
2.0	83.3	82.2	77.4
4.0	89.3	88.4	85.0
8.0	91.8	91.3	89.7
10.0	92.0	91.7	90.3
12.0	91.8	91.7	90.3
14.0	91.3	91.5	90.4
16.0	90.6	91.0	90.2
17.6	90.2	90.5	89.9
--	-	-	-
--	-	-	-



<b>Model</b> CES24050-16		Temperature 25°C Testing Circuitry Figure A																																
<b>Item</b> Line Regulation																																		
<b>Object</b> +5V16A																																		
<p>1. Graph</p> <p>---□--- Load 50% —△— Load 100%</p> <p>Output Voltage [V]</p> <p>Input Voltage [V]</p> <p>Note: Slanted line shows the range of the rated input voltage.</p>		<p>2. Values</p> <table border="1"> <thead> <tr> <th rowspan="2">Input Voltage [V]</th> <th colspan="2">Output Voltage [V]</th> </tr> <tr> <th>Load 50%</th> <th>Load 100%</th> </tr> </thead> <tbody> <tr><td>17</td><td>5.007</td><td>5.006</td></tr> <tr><td>18</td><td>5.007</td><td>5.006</td></tr> <tr><td>20</td><td>5.007</td><td>5.005</td></tr> <tr><td>24</td><td>5.008</td><td>5.005</td></tr> <tr><td>30</td><td>5.008</td><td>5.005</td></tr> <tr><td>36</td><td>5.008</td><td>5.005</td></tr> <tr><td>40</td><td>5.008</td><td>5.005</td></tr> <tr><td>--</td><td>-</td><td>-</td></tr> <tr><td>--</td><td>-</td><td>-</td></tr> </tbody> </table>	Input Voltage [V]	Output Voltage [V]		Load 50%	Load 100%	17	5.007	5.006	18	5.007	5.006	20	5.007	5.005	24	5.008	5.005	30	5.008	5.005	36	5.008	5.005	40	5.008	5.005	--	-	-	--	-	-
Input Voltage [V]	Output Voltage [V]																																	
	Load 50%	Load 100%																																
17	5.007	5.006																																
18	5.007	5.006																																
20	5.007	5.005																																
24	5.008	5.005																																
30	5.008	5.005																																
36	5.008	5.005																																
40	5.008	5.005																																
--	-	-																																
--	-	-																																





Model		CES24050-16	Temperature		25°C																																																			
Item		Load Regulation	Testing Circuitry		Figure A																																																			
Object		+5V16A																																																						
1. Graph			2. Values																																																					
<p> <span style="border-bottom: 1px solid black; margin-right: 5px;">—△—</span> Input Volt. 18V  <span style="border-bottom: 1px dashed black; margin-right: 5px;">---□---</span> Input Volt. 24V  <span style="border-bottom: 1px dash-dot black; margin-right: 5px;">-·-○-·-</span> Input Volt. 36V                 </p> <p style="text-align: center;">Load Current [A]</p>			<table border="1"> <thead> <tr> <th rowspan="2">Load Current [A]</th> <th colspan="3">Output Voltage [V]</th> </tr> <tr> <th>Input Volt. 18[V]</th> <th>Input Volt. 24[V]</th> <th>Input Volt. 36[V]</th> </tr> </thead> <tbody> <tr><td>0.0</td><td>5.006</td><td>5.007</td><td>5.007</td></tr> <tr><td>2.0</td><td>5.006</td><td>5.007</td><td>5.007</td></tr> <tr><td>4.0</td><td>5.006</td><td>5.007</td><td>5.007</td></tr> <tr><td>8.0</td><td>5.006</td><td>5.007</td><td>5.006</td></tr> <tr><td>10.0</td><td>5.006</td><td>5.007</td><td>5.006</td></tr> <tr><td>12.0</td><td>5.006</td><td>5.006</td><td>5.006</td></tr> <tr><td>14.0</td><td>5.006</td><td>5.006</td><td>5.006</td></tr> <tr><td>16.0</td><td>5.005</td><td>5.006</td><td>5.006</td></tr> <tr><td>17.6</td><td>5.005</td><td>5.005</td><td>5.005</td></tr> <tr><td>--</td><td>-</td><td>-</td><td>-</td></tr> <tr><td>--</td><td>-</td><td>-</td><td>-</td></tr> </tbody> </table>			Load Current [A]	Output Voltage [V]			Input Volt. 18[V]	Input Volt. 24[V]	Input Volt. 36[V]	0.0	5.006	5.007	5.007	2.0	5.006	5.007	5.007	4.0	5.006	5.007	5.007	8.0	5.006	5.007	5.006	10.0	5.006	5.007	5.006	12.0	5.006	5.006	5.006	14.0	5.006	5.006	5.006	16.0	5.005	5.006	5.006	17.6	5.005	5.005	5.005	--	-	-	-	--	-	-	-
Load Current [A]	Output Voltage [V]																																																							
	Input Volt. 18[V]	Input Volt. 24[V]	Input Volt. 36[V]																																																					
0.0	5.006	5.007	5.007																																																					
2.0	5.006	5.007	5.007																																																					
4.0	5.006	5.007	5.007																																																					
8.0	5.006	5.007	5.006																																																					
10.0	5.006	5.007	5.006																																																					
12.0	5.006	5.006	5.006																																																					
14.0	5.006	5.006	5.006																																																					
16.0	5.005	5.006	5.006																																																					
17.6	5.005	5.005	5.005																																																					
--	-	-	-																																																					
--	-	-	-																																																					
<p>Note: Slanted line shows the range of the rated load current.</p>																																																								

Model	CES24050-16	Temperature	25°C
Item	Dynamic Load Response	Testing Circuitry	Figure A
Object	+5V16A		

Input Volt. 24 V  
 Cycle 5 mS

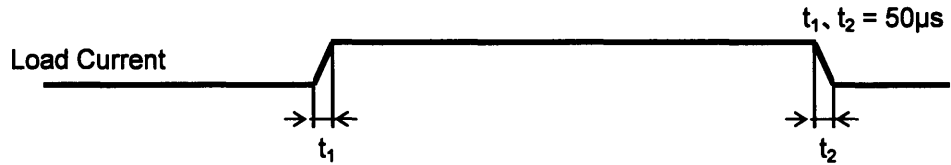

Min. Load (0A) ←→  
 Load 100% (16A)

100mV/div

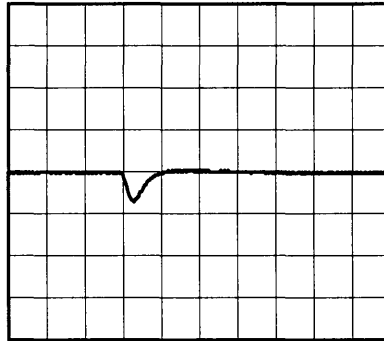

200µs/div

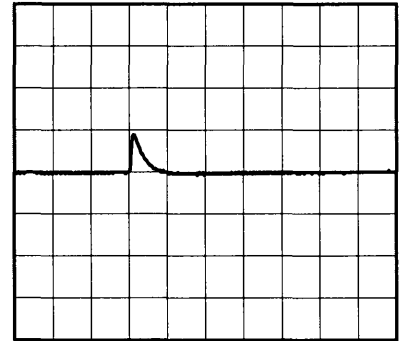

200µs/div

Min. Load (0A) ←→  
 Load 50% (8A)

100mV/div

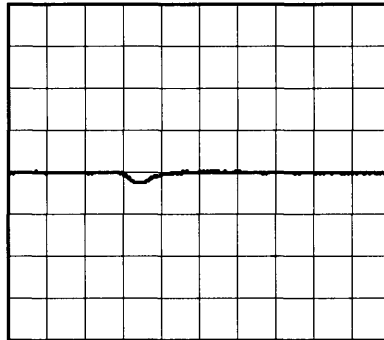

200µs/div

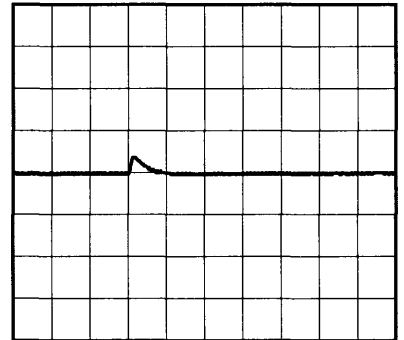

200µs/div

Load 50% (8A) ←→  
 Load 100% (16A)

100mV/div

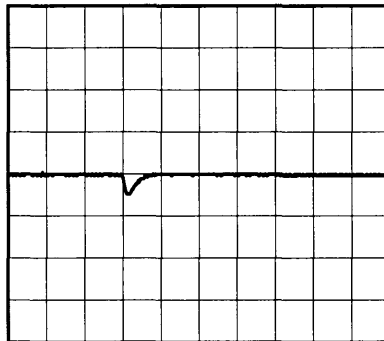

200µs/div



200µs/div



<table border="1"> <tr> <td>Model</td> <td>CES24050-16</td> </tr> <tr> <td>Item</td> <td>Ripple Voltage (by Load Current)</td> </tr> <tr> <td>Object</td> <td>+5V16A</td> </tr> </table>		Model	CES24050-16	Item	Ripple Voltage (by Load Current)	Object	+5V16A	Temperature 25°C Testing Circuitry Figure B																																
Model	CES24050-16																																							
Item	Ripple Voltage (by Load Current)																																							
Object	+5V16A																																							
<p>1. Graph</p> <div style="text-align: right;">                     —△— Input Volt. 18V                      - -○- - Input Volt. 36V                 </div> <p>Measured by 100 MHz Oscilloscope.                  Ripple Voltage is shown as p-p in the figure below.                  Note: Slanted line shows the range of the rated load current.</p>		<p>2. Values</p> <table border="1"> <thead> <tr> <th rowspan="2">Load Current [A]</th> <th colspan="2">Ripple Voltage [mV]</th> </tr> <tr> <th>Input Volt. 18 [V]</th> <th>Input Volt. 36 [V]</th> </tr> </thead> <tbody> <tr><td>0.0</td><td>5</td><td>5</td></tr> <tr><td>2.0</td><td>5</td><td>5</td></tr> <tr><td>4.0</td><td>5</td><td>5</td></tr> <tr><td>6.0</td><td>5</td><td>5</td></tr> <tr><td>8.0</td><td>5</td><td>5</td></tr> <tr><td>10.0</td><td>5</td><td>5</td></tr> <tr><td>12.0</td><td>5</td><td>5</td></tr> <tr><td>14.0</td><td>5</td><td>5</td></tr> <tr><td>16.0</td><td>5</td><td>5</td></tr> <tr><td>17.6</td><td>5</td><td>5</td></tr> <tr><td>--</td><td>-</td><td>-</td></tr> </tbody> </table>	Load Current [A]	Ripple Voltage [mV]		Input Volt. 18 [V]	Input Volt. 36 [V]	0.0	5	5	2.0	5	5	4.0	5	5	6.0	5	5	8.0	5	5	10.0	5	5	12.0	5	5	14.0	5	5	16.0	5	5	17.6	5	5	--	-	-
Load Current [A]	Ripple Voltage [mV]																																							
	Input Volt. 18 [V]	Input Volt. 36 [V]																																						
0.0	5	5																																						
2.0	5	5																																						
4.0	5	5																																						
6.0	5	5																																						
8.0	5	5																																						
10.0	5	5																																						
12.0	5	5																																						
14.0	5	5																																						
16.0	5	5																																						
17.6	5	5																																						
--	-	-																																						
<p>Ripple [mVp-p]</p> <p>Fig. Complex Ripple Wave Form</p>																																								



Model	CES24050-16	Temperature	25°C
Item	Ripple-Noise	Testing Circuitry	Figure B
Object	+5V16A		

1.Graph

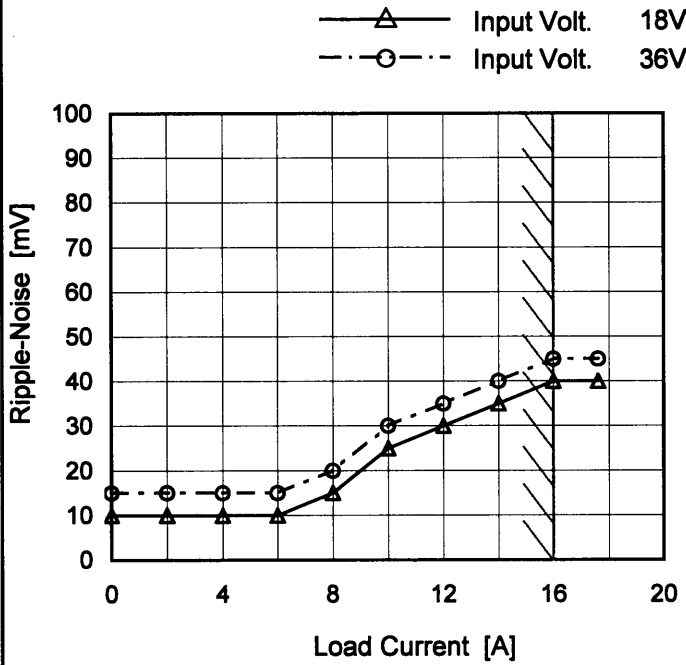

Measured by 100 MHz Oscilloscope.  
 Ripple-Noise is shown as p-p in the figure below.  
 Note: Slanted line shows the range of the rated load current.

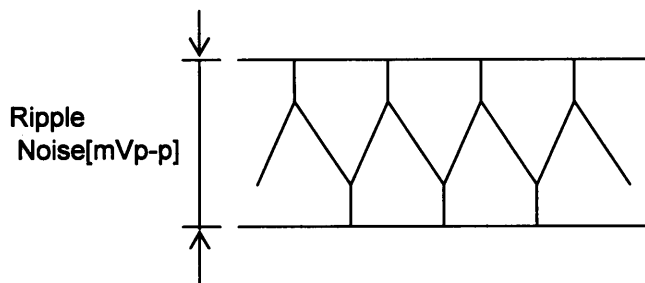

Fig.Complex Ripple Noise Wave Form

2.Values

Load Current [A]	Ripple-Noise [mV]	
	Input Volt. 18 [V]	Input Volt. 36 [V]
0.0	10	15
2.0	10	15
4.0	10	15
6.0	10	15
8.0	15	20
10.0	25	30
12.0	30	35
14.0	35	40
16.0	40	45
17.6	40	45
-	-	-



<b>Model</b>		CES24050-16		Testing Circuitry Figure B																																						
<b>Item</b>		Ripple Voltage (by Ambient Temp.)																																								
<b>Object</b>		+5V16A																																								
<p>1. Graph</p> <div style="text-align: right; margin-bottom: 10px;"> <p>---□--- Load 50%</p> <p>—△— Load 100%</p> </div> <p style="text-align: center;">Ambient Temperature [°C]</p> <p style="text-align: center;">Input Volt. 24V</p>			<p>2. Values</p> <table border="1" style="width: 100%; border-collapse: collapse; text-align: center;"> <thead> <tr> <th rowspan="2">Ambient Temperature [°C]</th> <th colspan="2">Ripple Voltage [mV]</th> </tr> <tr> <th>Load 50%</th> <th>Load 100%</th> </tr> </thead> <tbody> <tr><td>-40</td><td>5</td><td>5</td></tr> <tr><td>-20</td><td>5</td><td>5</td></tr> <tr><td>0</td><td>5</td><td>5</td></tr> <tr><td>25</td><td>5</td><td>5</td></tr> <tr><td>40</td><td>5</td><td>5</td></tr> <tr><td>60</td><td>5</td><td>5</td></tr> <tr><td>85</td><td>5</td><td>5</td></tr> <tr><td>--</td><td>-</td><td>-</td></tr> <tr><td>--</td><td>-</td><td>-</td></tr> <tr><td>--</td><td>-</td><td>-</td></tr> <tr><td>--</td><td>-</td><td>-</td></tr> </tbody> </table>		Ambient Temperature [°C]	Ripple Voltage [mV]		Load 50%	Load 100%	-40	5	5	-20	5	5	0	5	5	25	5	5	40	5	5	60	5	5	85	5	5	--	-	-	--	-	-	--	-	-	--	-	-
Ambient Temperature [°C]	Ripple Voltage [mV]																																									
	Load 50%	Load 100%																																								
-40	5	5																																								
-20	5	5																																								
0	5	5																																								
25	5	5																																								
40	5	5																																								
60	5	5																																								
85	5	5																																								
--	-	-																																								
--	-	-																																								
--	-	-																																								
--	-	-																																								
<p>Measured by 100 MHz Oscilloscope.                  Note: Slanted line shows the range of the rated ambient temperature.</p>																																										



Model	CES24050-16
Item	Ambient Temperature Drift
Object	+5V16A

Testing Circuitry Figure A

1. Graph

- △— Input Volt. 18V
- Input Volt. 24V
- Input Volt. 36V

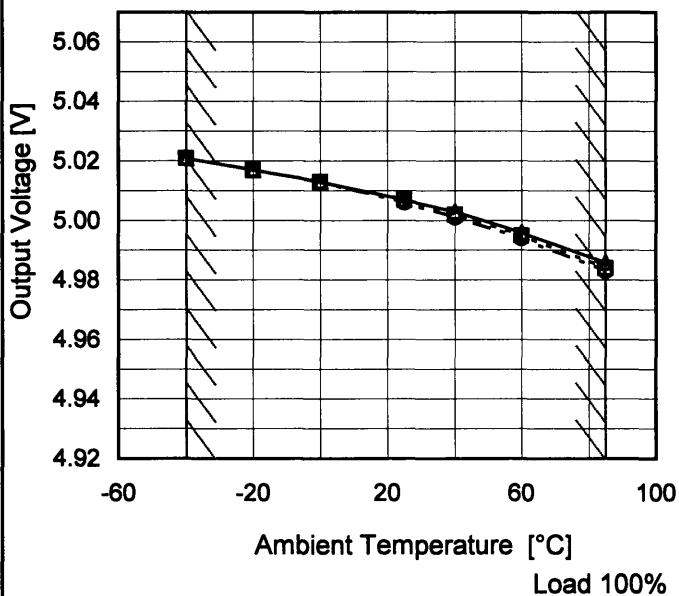

2. Values

Ambient Temperature [°C]	Output Voltage [V]		
	Input Volt. 18[V]	Input Volt. 24[V]	Input Volt. 36[V]
-40	5.021	5.021	5.021
-20	5.017	5.017	5.017
0	5.013	5.013	5.013
25	5.007	5.007	5.006
40	5.003	5.002	5.001
60	4.996	4.995	4.994
85	4.986	4.984	4.983
--	-	-	-
--	-	-	-
--	-	-	-
--	-	-	-

Note: Slanted line shows the range of the rated ambient temperature.



<b>COSEL</b>		
Model	CES24050-16	
Item	Output Voltage Accuracy	Testing Circuitry Figure A
Object	+5V16A	

1. Output Voltage Accuracy

This is defined as the value of the output voltage, regulation load, ambient temperature and input voltage varied at random in the range as specified below.

Temperature : -40 - 85°C

Input Voltage : 18 - 36V

Load Current : 0 - 16A

\* Output Voltage Accuracy =  $\pm(\text{Maximum of Output Voltage} - \text{Minimum of Output Voltage}) / 2$

\* Output Voltage Accuracy (Ration) =  $\frac{\text{Output Voltage Accuracy}}{\text{Rated Output Voltage}} \times 100$

2. Values

Item	Temperature [°C]	Input Voltage[V]	Output		Output Voltage Accuracy	
			Current[A]	Voltage[V]	Value [mV]	Ration [%]
Maximum Voltage	-40	36	0	5.021	±19	±0.4
Minimum Voltage	85	36	16	4.983		



<b>COSEL</b>																									
Model	CES24050-16	Temperature	25°C																						
Item	Time Lapse Drift	Testing Circuitry	Figure A																						
Object	+5V16A																								
<p>1. Graph</p> <p style="text-align: center;">Time [H]</p> <p>Input Volt.     24V Load             100%</p>		<p>2. Values</p> <table border="1"> <thead> <tr> <th>Time since start [H]</th> <th>Output Voltage [V]</th> </tr> </thead> <tbody> <tr><td>0.0</td><td>5.009</td></tr> <tr><td>0.5</td><td>5.003</td></tr> <tr><td>1.0</td><td>5.003</td></tr> <tr><td>2.0</td><td>5.003</td></tr> <tr><td>3.0</td><td>5.003</td></tr> <tr><td>4.0</td><td>5.003</td></tr> <tr><td>5.0</td><td>5.003</td></tr> <tr><td>6.0</td><td>5.003</td></tr> <tr><td>7.0</td><td>5.004</td></tr> <tr><td>8.0</td><td>5.004</td></tr> </tbody> </table>		Time since start [H]	Output Voltage [V]	0.0	5.009	0.5	5.003	1.0	5.003	2.0	5.003	3.0	5.003	4.0	5.003	5.0	5.003	6.0	5.003	7.0	5.004	8.0	5.004
Time since start [H]	Output Voltage [V]																								
0.0	5.009																								
0.5	5.003																								
1.0	5.003																								
2.0	5.003																								
3.0	5.003																								
4.0	5.003																								
5.0	5.003																								
6.0	5.003																								
7.0	5.004																								
8.0	5.004																								





Model	CES24050-16	Temperature	25°C
Item	Rise and Fall Time	Testing Circuitry	Figure A
Object	+5V16A		

1. Graph

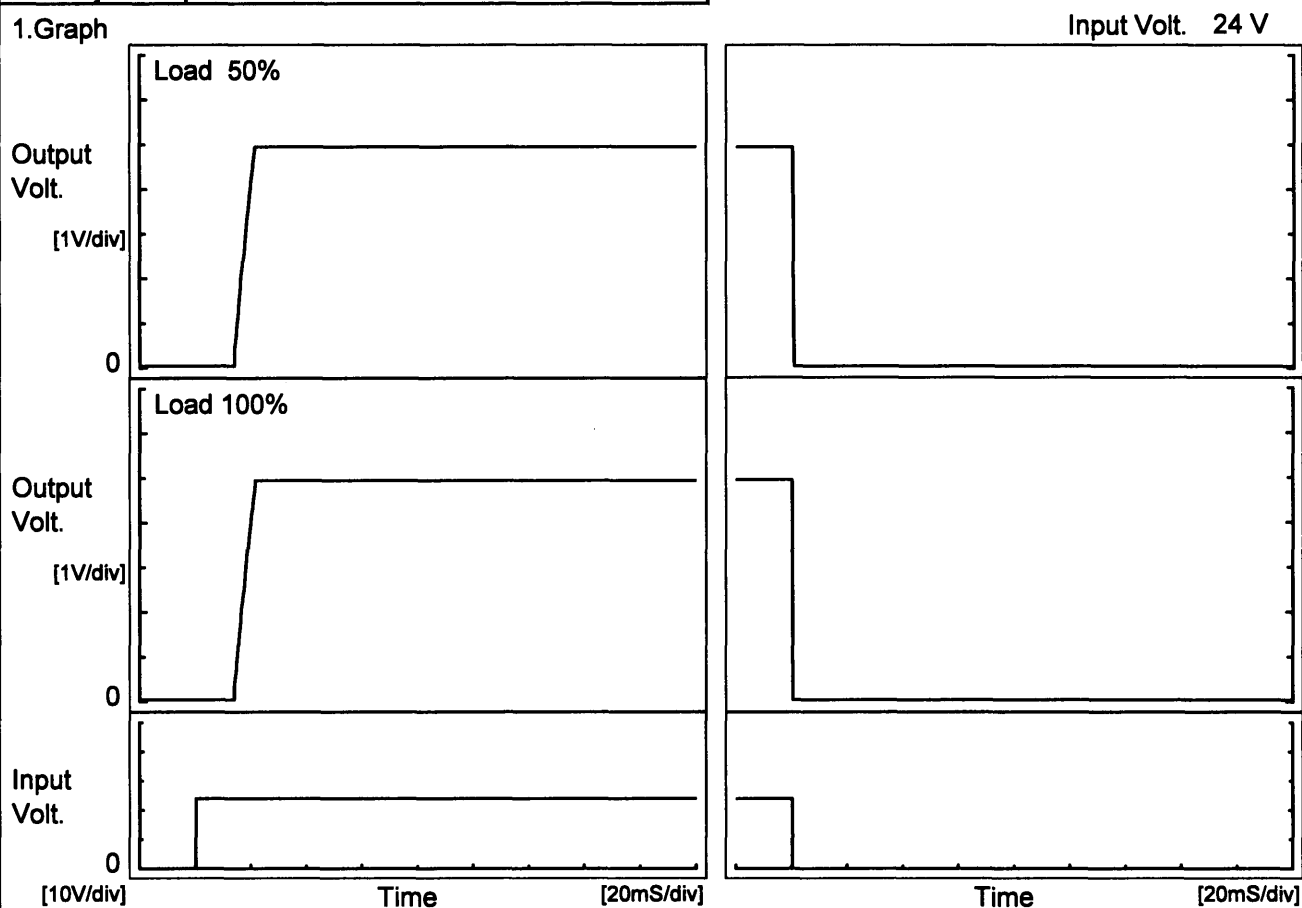

2. Values

Load	Time	Td	Tr	Ts	Th	Tf
50 %		14.3	6.6	20.9	0.2	0.3
100 %		14.3	6.8	21.1	0.2	0.1

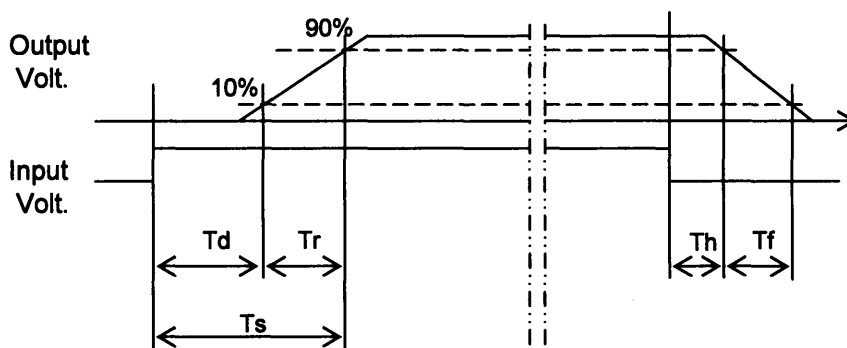



<b>COSEL</b>																																								
Model	CES24050-16																																							
Item	Minimum Input Voltage for Regulated Output Voltage	Testing Circuitry Figure A																																						
Object	+5V16A																																							
<p>1. Graph</p> <div style="text-align: right;"> <p>---□--- Load 50%</p> <p>—△— Load 100%</p> </div> <p style="text-align: center;">Ambient Temperature [°C]</p>		<p>2. Values</p> <table border="1"> <thead> <tr> <th rowspan="2">Ambient Temperature [°C]</th> <th colspan="2">Input Voltage [V]</th> </tr> <tr> <th>Load 50%</th> <th>Load 100%</th> </tr> </thead> <tbody> <tr><td>-40</td><td>15.7</td><td>15.8</td></tr> <tr><td>-20</td><td>15.7</td><td>15.8</td></tr> <tr><td>0</td><td>15.7</td><td>15.7</td></tr> <tr><td>25</td><td>15.7</td><td>15.7</td></tr> <tr><td>40</td><td>15.7</td><td>15.7</td></tr> <tr><td>60</td><td>15.7</td><td>15.7</td></tr> <tr><td>85</td><td>15.7</td><td>15.7</td></tr> <tr><td>--</td><td>-</td><td>-</td></tr> <tr><td>--</td><td>-</td><td>-</td></tr> <tr><td>--</td><td>-</td><td>-</td></tr> <tr><td>--</td><td>-</td><td>-</td></tr> </tbody> </table>	Ambient Temperature [°C]	Input Voltage [V]		Load 50%	Load 100%	-40	15.7	15.8	-20	15.7	15.8	0	15.7	15.7	25	15.7	15.7	40	15.7	15.7	60	15.7	15.7	85	15.7	15.7	--	-	-	--	-	-	--	-	-	--	-	-
Ambient Temperature [°C]	Input Voltage [V]																																							
	Load 50%	Load 100%																																						
-40	15.7	15.8																																						
-20	15.7	15.8																																						
0	15.7	15.7																																						
25	15.7	15.7																																						
40	15.7	15.7																																						
60	15.7	15.7																																						
85	15.7	15.7																																						
--	-	-																																						
--	-	-																																						
--	-	-																																						
--	-	-																																						
<p>Note: Slanted line shows the range of the rated ambient temperature.</p>																																								



<p><b>Model</b> CES24050-16</p>		<p>Temperature 25°C Testing Circuitry Figure A</p>																																																							
<p><b>Item</b> Overcurrent Protection</p>																																																									
<p><b>Object</b> +5V16A</p>																																																									
<p>1. Graph</p> <div style="display: flex; align-items: center;"> <div style="margin-right: 20px;"> <p>————— Input Volt. 18V</p> <p>————— Input Volt. 24V</p> <p>————— Input Volt. 36V</p> </div> </div> <p>Output Voltage [V]</p> <p>Load Current [A]</p> <p>Note: Slanted line shows the range of the rated load current.</p> <p>When the output voltage fell lower than 4.0V, the unit shuts off the output by operating low voltage protection.</p>		<p>2. Values</p> <table border="1"> <thead> <tr> <th rowspan="2">Output Voltage [V]</th> <th colspan="3">Load Current [A]</th> </tr> <tr> <th>Input Volt. 18[V]</th> <th>Input Volt. 24[V]</th> <th>Input Volt. 36[V]</th> </tr> </thead> <tbody> <tr><td>5.00</td><td>19.87</td><td>19.94</td><td>20.17</td></tr> <tr><td>4.75</td><td>19.76</td><td>19.81</td><td>20.07</td></tr> <tr><td>4.50</td><td>19.58</td><td>19.67</td><td>19.96</td></tr> <tr><td>4.00</td><td>19.23</td><td>19.48</td><td>19.77</td></tr> <tr><td>3.50</td><td>19.07</td><td>19.37</td><td>19.71</td></tr> <tr><td>3.40</td><td>19.04</td><td>19.36</td><td>19.72</td></tr> <tr><td>--</td><td>-</td><td>-</td><td>-</td></tr> <tr><td>--</td><td>-</td><td>-</td><td>-</td></tr> <tr><td>--</td><td>-</td><td>-</td><td>-</td></tr> <tr><td>--</td><td>-</td><td>-</td><td>-</td></tr> <tr><td>--</td><td>-</td><td>-</td><td>-</td></tr> <tr><td>--</td><td>-</td><td>-</td><td>-</td></tr> </tbody> </table>	Output Voltage [V]	Load Current [A]			Input Volt. 18[V]	Input Volt. 24[V]	Input Volt. 36[V]	5.00	19.87	19.94	20.17	4.75	19.76	19.81	20.07	4.50	19.58	19.67	19.96	4.00	19.23	19.48	19.77	3.50	19.07	19.37	19.71	3.40	19.04	19.36	19.72	--	-	-	-	--	-	-	-	--	-	-	-	--	-	-	-	--	-	-	-	--	-	-	-
Output Voltage [V]	Load Current [A]																																																								
	Input Volt. 18[V]	Input Volt. 24[V]	Input Volt. 36[V]																																																						
5.00	19.87	19.94	20.17																																																						
4.75	19.76	19.81	20.07																																																						
4.50	19.58	19.67	19.96																																																						
4.00	19.23	19.48	19.77																																																						
3.50	19.07	19.37	19.71																																																						
3.40	19.04	19.36	19.72																																																						
--	-	-	-																																																						
--	-	-	-																																																						
--	-	-	-																																																						
--	-	-	-																																																						
--	-	-	-																																																						
--	-	-	-																																																						



Model		CES24050-16		Testing Circuitry Figure A																																																				
Item		Overvoltage Protection																																																						
Object		+5V16A																																																						
1.Graph		—△—	Input Volt. 18V	2.Values																																																				
		---□---	Input Volt. 24V																																																					
		---○---	Input Volt. 36V																																																					
<p style="text-align: center;">Load 0%</p>				<table border="1"> <thead> <tr> <th rowspan="2">Ambient Temperature [°C]</th> <th colspan="3">Operating Point [V]</th> </tr> <tr> <th>Input Volt. 18[V]</th> <th>Input Volt. 24[V]</th> <th>Input Volt. 36[V]</th> </tr> </thead> <tbody> <tr><td>-40</td><td>6.50</td><td>6.50</td><td>6.50</td></tr> <tr><td>-20</td><td>6.50</td><td>6.50</td><td>6.50</td></tr> <tr><td>0</td><td>6.50</td><td>6.50</td><td>6.50</td></tr> <tr><td>25</td><td>6.50</td><td>6.50</td><td>6.50</td></tr> <tr><td>40</td><td>6.49</td><td>6.49</td><td>6.49</td></tr> <tr><td>60</td><td>6.48</td><td>6.48</td><td>6.48</td></tr> <tr><td>85</td><td>6.46</td><td>6.47</td><td>6.47</td></tr> <tr><td>--</td><td>-</td><td>-</td><td>-</td></tr> <tr><td>--</td><td>-</td><td>-</td><td>-</td></tr> <tr><td>--</td><td>-</td><td>-</td><td>-</td></tr> <tr><td>--</td><td>-</td><td>-</td><td>-</td></tr> </tbody> </table>		Ambient Temperature [°C]	Operating Point [V]			Input Volt. 18[V]	Input Volt. 24[V]	Input Volt. 36[V]	-40	6.50	6.50	6.50	-20	6.50	6.50	6.50	0	6.50	6.50	6.50	25	6.50	6.50	6.50	40	6.49	6.49	6.49	60	6.48	6.48	6.48	85	6.46	6.47	6.47	--	-	-	-	--	-	-	-	--	-	-	-	--	-	-	-
Ambient Temperature [°C]	Operating Point [V]																																																							
	Input Volt. 18[V]	Input Volt. 24[V]	Input Volt. 36[V]																																																					
-40	6.50	6.50	6.50																																																					
-20	6.50	6.50	6.50																																																					
0	6.50	6.50	6.50																																																					
25	6.50	6.50	6.50																																																					
40	6.49	6.49	6.49																																																					
60	6.48	6.48	6.48																																																					
85	6.46	6.47	6.47																																																					
--	-	-	-																																																					
--	-	-	-																																																					
--	-	-	-																																																					
--	-	-	-																																																					
<p>Note: Slanted line shows the range of the rated ambient temperature.</p>																																																								

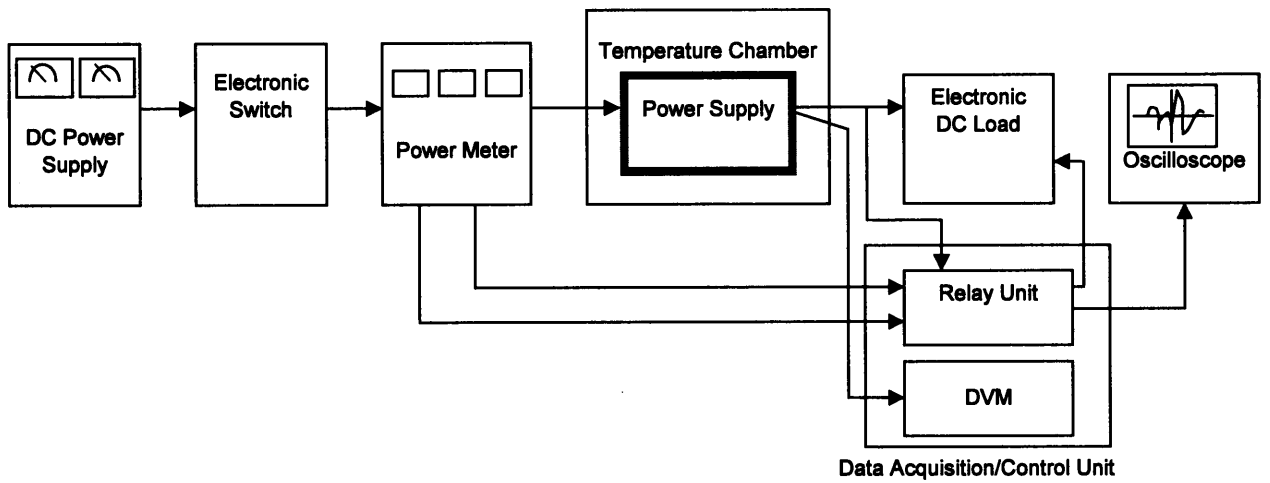

Figure A

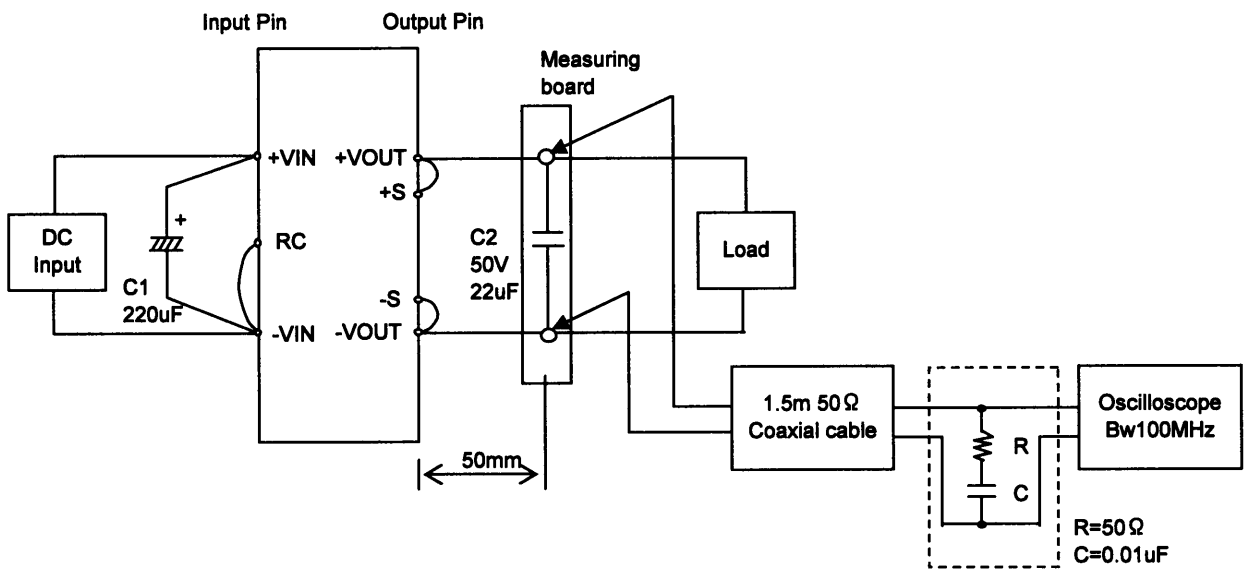

Figure B