

<b>DATA SHEET</b>		Date	06-Jan-17
Model	MGFS1R54805	Temp.	25 degreeC
Test	EMI Line conduction & Radiated emission	Humid.	40 %RH
		Tested by	S.Mukaide

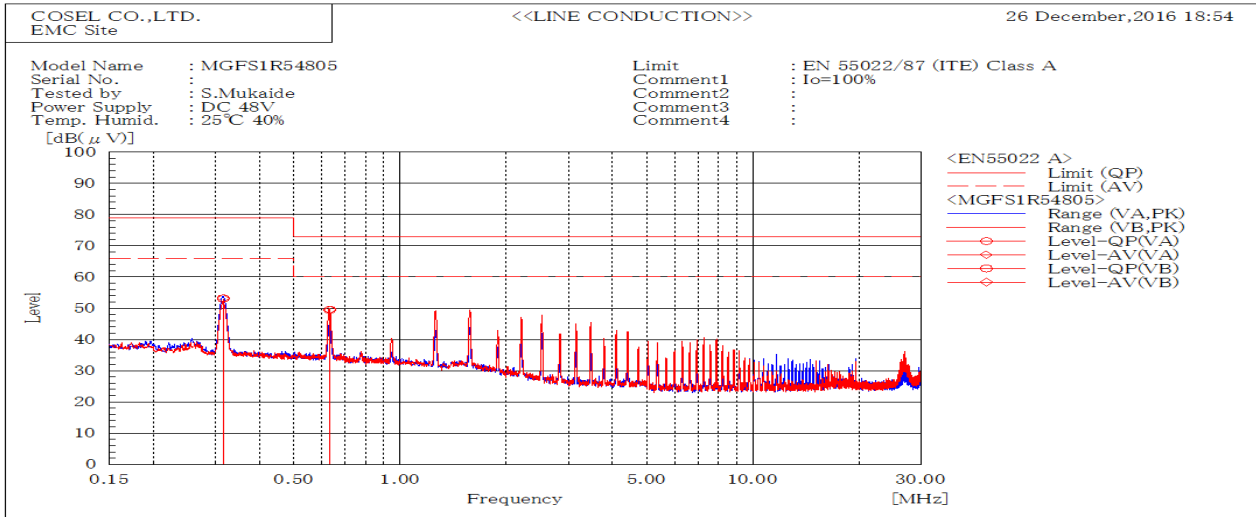

Frequency MHz	Line Phase	Level dB(uV)		Limit dB(uV)		Margin dB		Pass/Fail	Remark
		QP	AV	QP	AV	QP	AV		
0.31539	VA	53.1	53.2	79	66	25.9	12.8	Pass	
0.63274	VB	49.5	49.5	73	60	23.5	10.5	Pass	

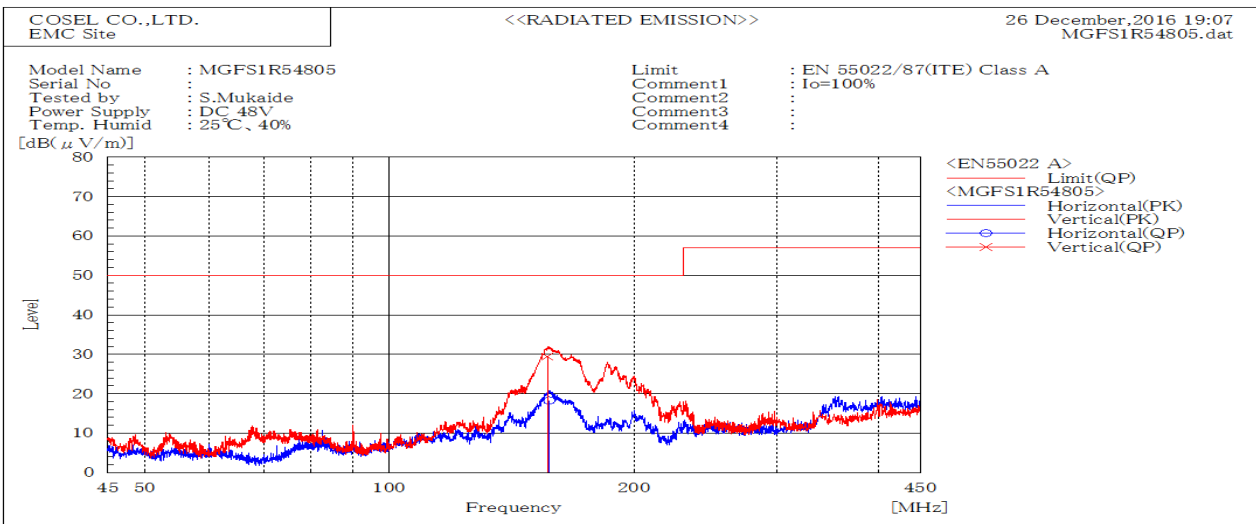

Frequency MHz	Polarization	Stability	Reading dB(uV)	Limit dB(uV/m)	Margin dB(uV/m)	Pass/Fail	Height cm	Angle deg	Remark
			QP	QP	QP				
156.477	V	Stable	29.4	50.0	20.6	Pass	158	93	
157.198	H	Stable	18.3	50.0	31.7	Pass	153	329	

DATA SHEET		Date	06-Jan-17
Model	Circuit used for measurement	Temp.	25 degreeC
Test	EMI Line conduction & Radiated emission	Humid.	40 %RH
		Tested by	S.Mukaide

## 1. Line conduction

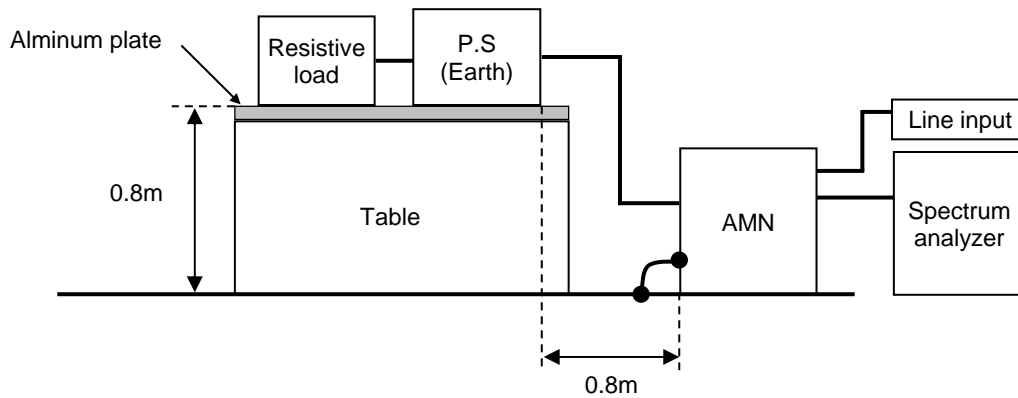

## 2. Radiated emission

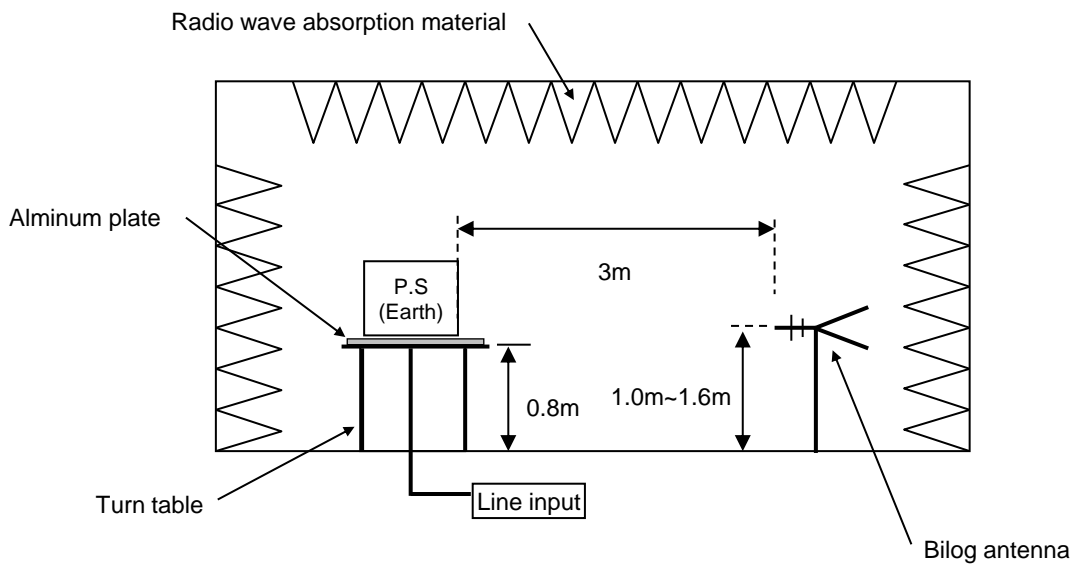

## Conditions

Test : EMI  
 Model Name : MGFS1R5□□

○Photographs of Test Set-Up

**LINE CONDUCTION**

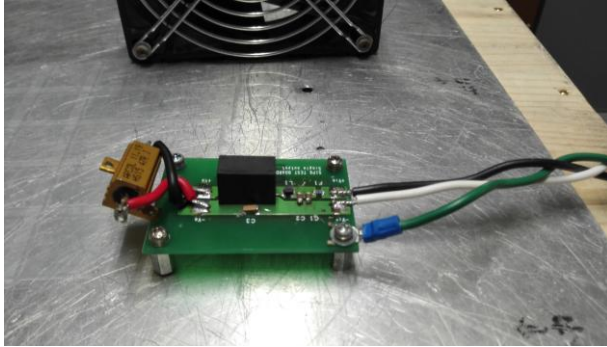

**RADIATED EMISSION**

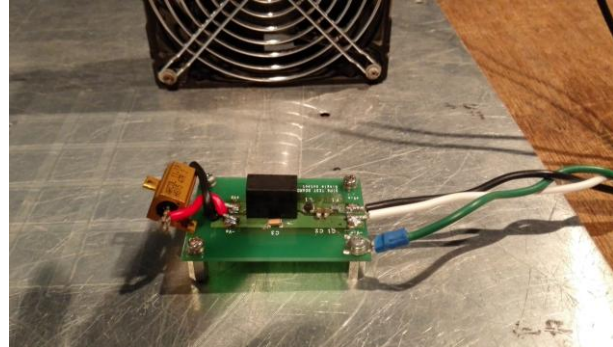

○Testing circuitry

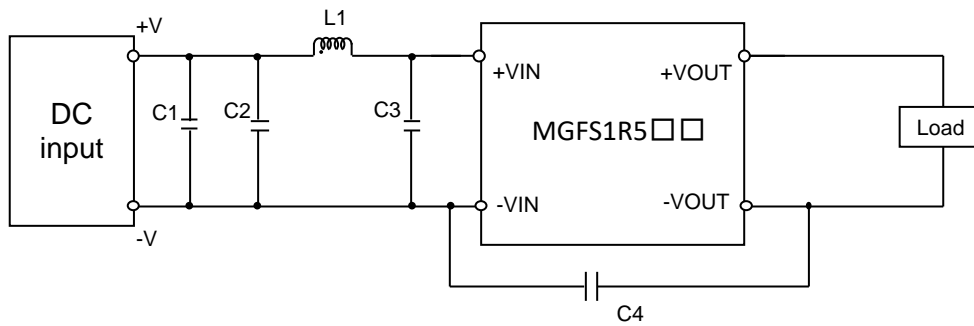

- |      |             |                                                                     |
|------|-------------|---------------------------------------------------------------------|
| C1 : | MGFS1R524□□ | 50V 4.7μ F Ceramic capacitor (GRM31CR71H475K MURATA MANUFACTURING)  |
|      | MGFS1R548□□ | 100V 2.2μ F Ceramic capacitor (GRM31CR72A225K MURATA MANUFACTURING) |
| C2 : | MGFS1R524□□ | 50V 4.7μ F Ceramic capacitor (GRM31CR71H475K MURATA MANUFACTURING)  |
|      | MGFS1R548□□ | 100V 2.2μ F Ceramic capacitor (GRM31CR72A225K MURATA MANUFACTURING) |
| C3 : | MGFS1R524□□ | 50V 4.7μ F Ceramic capacitor (GRM31CR71H475K MURATA MANUFACTURING)  |
|      | MGFS1R548□□ | 100V 2.2μ F Ceramic capacitor (GRM31CR72A225K MURATA MANUFACTURING) |
| C4 : | MGFS1R524□□ | 2kV 470pF Ceramic capacitor (GR442QR73D471K MURATA MANUFACTURING)   |
|      | MGFS1R548□□ | 2kV 1000pF Ceramic capacitor (GR442QR73D102K MURATA MANUFACTURING)  |
| L1 : | MGFS1R524□□ | 900mA 10μ H Inductor(LQH32PN100MNCL MURATA MANUFACTURING)           |
|      | MGFS1R548□□ | 550mA 22μ H Inductor(LQH32PN220MNCL MURATA MANUFACTURING)           |