

NBH-06-432

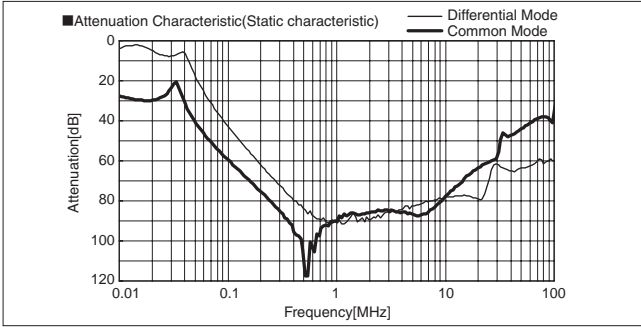

NBH-10-432

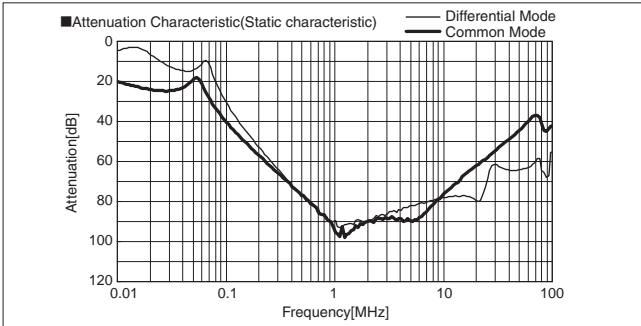

NBH-16-432

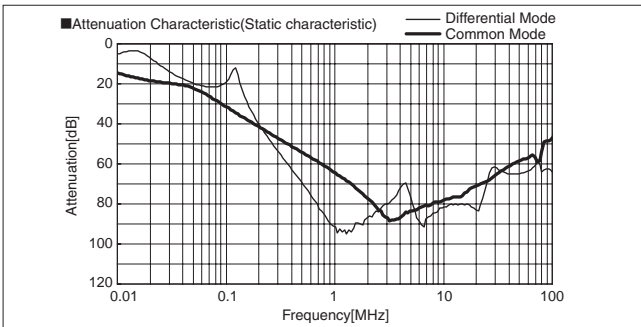

NBH-20-432

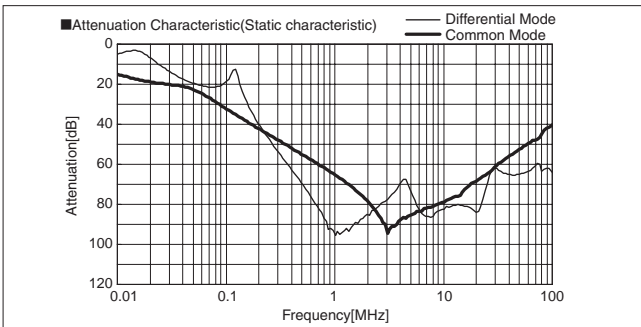

NBH-30-432

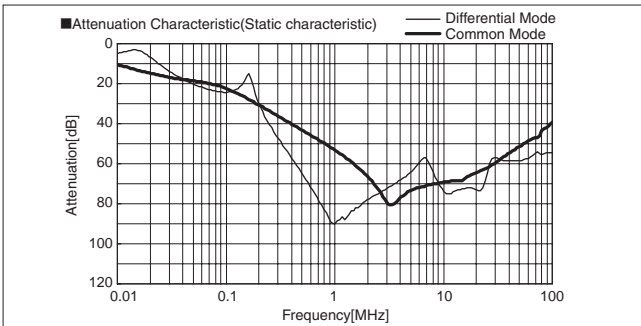

1 Calculating the input current of three-phase electric equipment

The input current of three-phase electric equipment is calculated by the next formula.

$$\text{Input current(A)} = \frac{\text{Input capacity of the equipment(VA)}}{\text{Input voltage(V)} \times \sqrt{3}}$$

Calculation examples are shown below.

(1) Input Voltage : 200 VAC

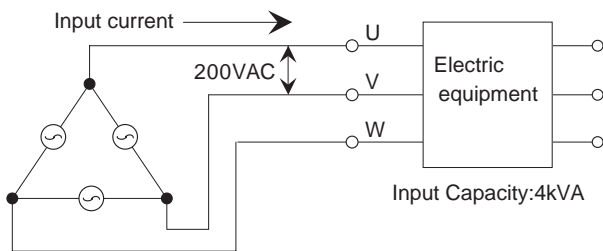

$$\text{Input current} = \frac{4000(\text{VA})}{200(\text{V}) \times \sqrt{3}} = 11.6(\text{A})$$

(2) Input Voltage : 400 VAC

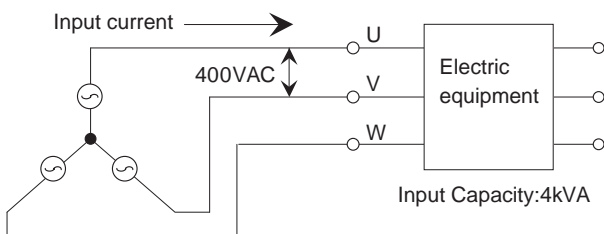

$$\text{Input current} = \frac{4000(\text{VA})}{400(\text{V}) \times \sqrt{3}} = 5.8(\text{A})$$

2 Connection with a general-purpose inverter (servo driver)

The noise filter cannot be used between the inverter (servo driver) and the motor, because the noise filter might cause abnormal heat. Please connect the noise filter to input side of inverter driver (servo driver).

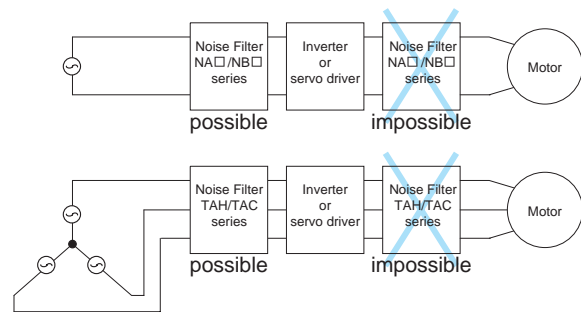

3 Safety Considerations

- To apply for safety standard approval using this Noise Filter, the following conditions must be met.
- The unit must be used as a component of an end-use equipment.
- Protection earth terminal (PE) must be connected to safety ground of end-use equipment.

1 Noise Transmission

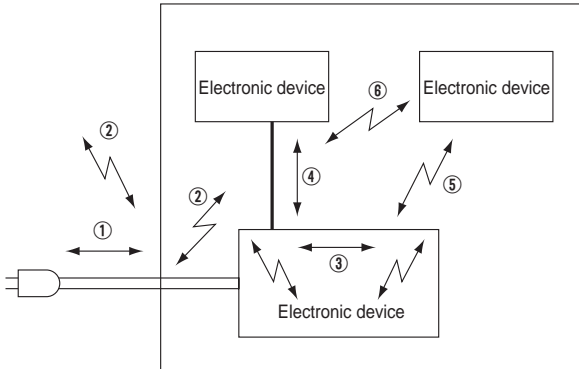

Noise transmission between electric power and electronic device

- ① Conducted noise from electric power lines.
- ② Radiated noise which is picked up and generated by the power line as antenna.
- ③ Conducted and radiated noise which is generated in the electronic device.
- ④ Conducted noise which is generated by the signal lines between electronic devices.
- ⑤ Radiated noise emitted an electronic device that interferes with other device.
- ⑥ Radiated noise which is picked up and generated by the signal line as antenna.

2 Application Precautions

The following points should be kept in mind to use the noise filter more effectively.

- Input wire and output wire of the noise filter should be separated. When the input/output wire are bundled together or wired parallel with each other, high frequency noise is induced so, and the expected effect of noise attenuation cannot be achieved.

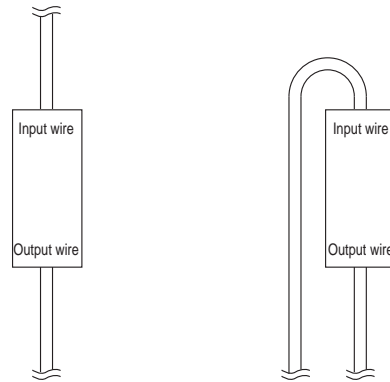

Good wiring example

Bad wiring example

- Ground lines should be as short as possible. If it is not, an equivalent inductance appears, and the high frequency attenuation characteristics degrade. When grounding the mounting plate of the noise filter, you should remove the paint to reduce the contact resistance from the equipment case, and then install the noise filter.

3 Method of measuring characteristic data

※ Attenuation = $20\log(U_{in}/U_{out})$ [dB]
 U_{in} : Voltage in state without filters
 U_{out} : Voltage in state which added filters
 ※ N.A.: Network analyzer

(1) Attenuation Characteristic(Static characteristic)

Object product:NBH,NBC,NBM,NAH,NAC,NAM,NAP

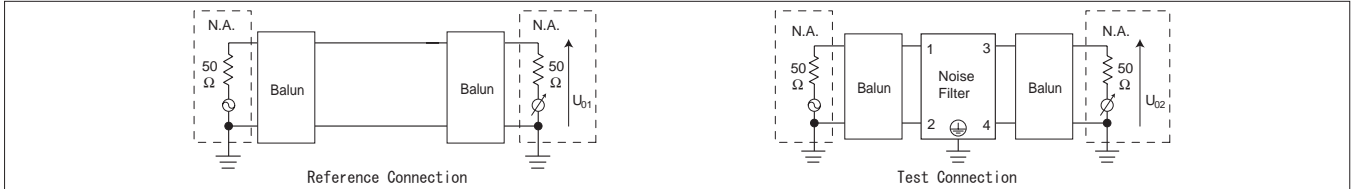

Fig.3.1 Differential mode attenuation measurement diagram



Fig.3.2 Common mode attenuation measurement diagram

Object product:TAH,TAC

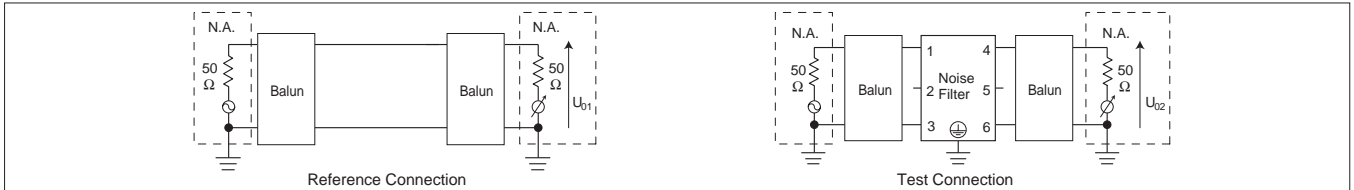

Fig.3.3 Differential mode attenuation measurement diagram

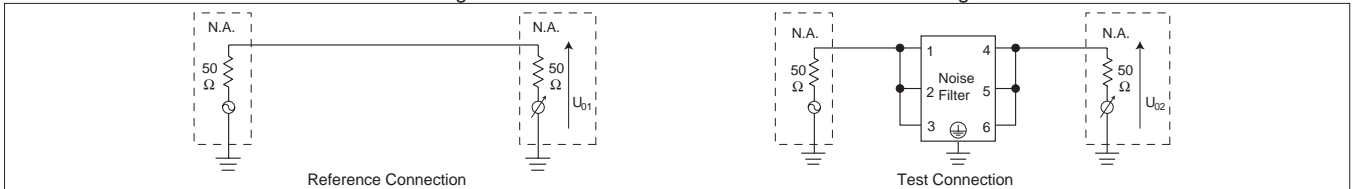

Fig.3.4 Common mode attenuation measurement diagram

Object product:SNR,SNA

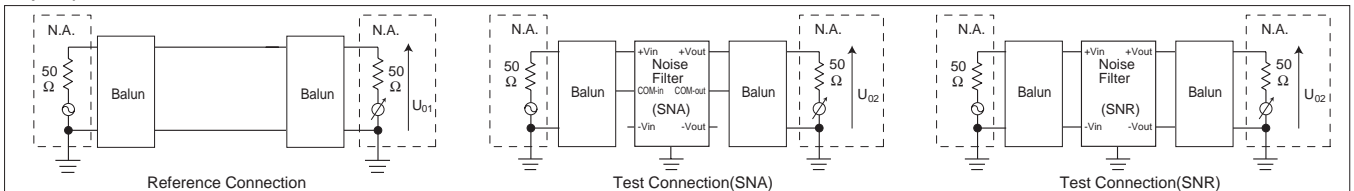

Fig.3.5 Differential mode attenuation measurement diagram

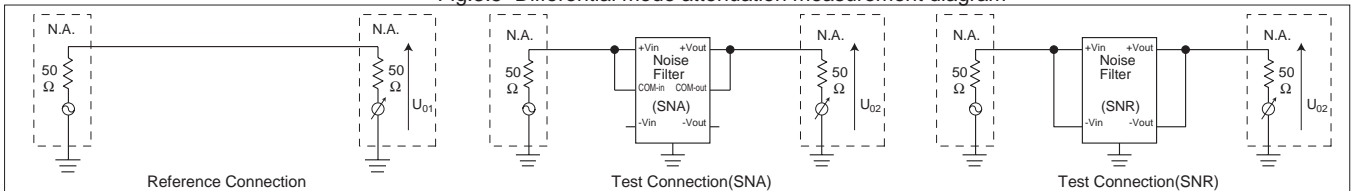

Fig.3.6 Common mode attenuation measurement diagram

(2) Pulse Attenuation Characteristic

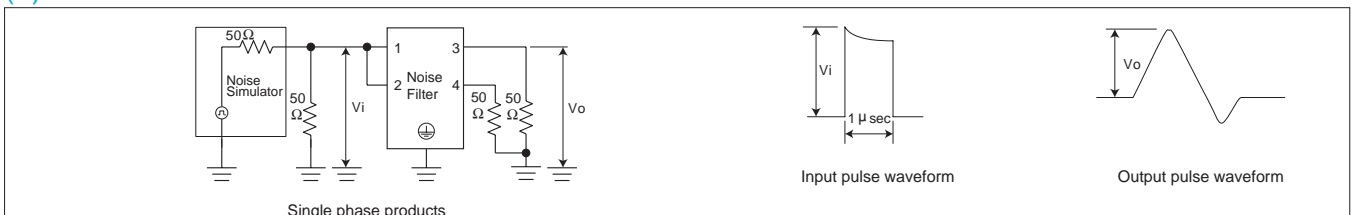

Fig.3.7 Pulse attenuation measurement diagram