

# R Series Attachment

BASE Attachment

Plate model	Applicable models
F-R10-1	R10A
F-R15-1	R15A
F-R25-1	R25A
F-R50-1	R50A
F-R100-1	R100
F-R150-1	R150

Example (R100)

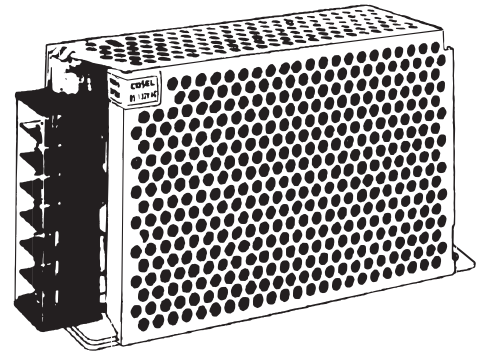

< TOP VIEW > (Unit : mm) (Tolerance : ±1)

<p><b>F-R10-1</b></p> <p>Size</p> <ul style="list-style-type: none"> <li>* Material : SPCC</li> <li>* Thickness : 2.0</li> <li>* Weight : 40g max</li> </ul>	<p><b>F-R15-1</b></p> <p>Size</p> <ul style="list-style-type: none"> <li>* Material : SPCC</li> <li>* Thickness : 2.0</li> <li>* Weight : 50g max</li> </ul>
<p>* M3 Flat screw is requested when mounting. Please check the instruction manual for the size of screw.</p>	
<p>Mounting hole size</p> <p>FRONT←</p>	<p>Mounting hole size</p> <p>FRONT←</p>
<p><b>F-R25-1</b></p> <p>Size</p> <ul style="list-style-type: none"> <li>* Material : SPCC</li> <li>* Thickness : 2.0</li> <li>* Weight : 65g max</li> </ul>	<p><b>F-R50-1</b></p> <p>Size</p> <ul style="list-style-type: none"> <li>* Material : SPCC</li> <li>* Thickness : 2.0</li> <li>* Weight : 80g max</li> </ul>
<p>* M3 Flat screw is requested when mounting. Please check the instruction manual for the size of screw.</p>	
<p>Mounting hole size</p> <p>FRONT←</p>	<p>Mounting hole size</p> <p>FRONT←</p>
<p><b>F-R100-1</b></p> <p>Size</p> <ul style="list-style-type: none"> <li>* Material : SPCC</li> <li>* Thickness : 2.0</li> <li>* Weight : 110g max</li> </ul>	<p><b>F-R150-1</b></p> <p>Size</p> <ul style="list-style-type: none"> <li>* Material : SPCC</li> <li>* Thickness : 2.0</li> <li>* Weight : 150g max</li> </ul>
<p>* M4 Flat screw is requested when mounting. Please check the instruction manual for the size of screw.</p>	
<p>Mounting hole size</p> <p>FRONT←</p>	<p>Mounting hole size</p> <p>FRONT←</p>

FRONT · REVERSE  
Attachment

Plate model	Applicable models
F-K10-2	R10A
F-R15-2	R15A
F-R25-2	R25A
F-R50-2	R50A
F-R100-2	R100
F-R150-2	R150

Example

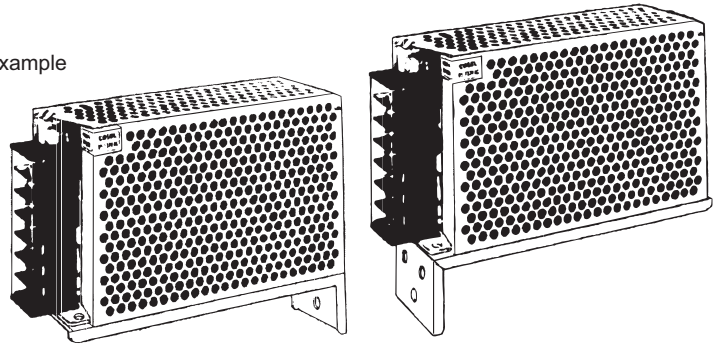

< TOP VIEW > (Unit : mm) (Tolerance : ±1)

<p style="text-align: center;"><b>F-K10-2</b></p> <p>Size</p> <ul style="list-style-type: none"> <li>★ Material : SPCC</li> <li>★ Thickness : 1.6</li> <li>★ Weight : 60g max</li> </ul>	<p style="text-align: center;"><b>F-R15-2</b></p> <p>Size</p> <ul style="list-style-type: none"> <li>★ Material : SPCC</li> <li>★ Thickness : 1.6</li> <li>★ Weight : 75g max</li> </ul>
<p>★ M3 screw is requested when mounting. Please check the instruction manual for the size of screw.</p>	
<p style="text-align: center;"><b>F-R25-2</b></p> <p>Size</p> <ul style="list-style-type: none"> <li>★ Material : SPCC</li> <li>★ Thickness : 1.6</li> <li>★ Weight : 85g max</li> </ul>	<p style="text-align: center;"><b>F-R50-2</b></p> <p>Size</p> <ul style="list-style-type: none"> <li>★ Material : SPCC</li> <li>★ Thickness : 1.6</li> <li>★ Weight : 100g max</li> </ul>
<p>★ M3 screw is requested when mounting. Please check the instruction manual for the size of screw.</p>	
<p style="text-align: center;"><b>F-R100-2</b></p> <p>Size</p> <ul style="list-style-type: none"> <li>★ Material : SPCC</li> <li>★ Thickness : 1.6</li> <li>★ Weight : 130g max</li> </ul>	<p style="text-align: center;"><b>F-R150-2</b></p> <p>Size</p> <ul style="list-style-type: none"> <li>★ Material : SPCC</li> <li>★ Thickness : 2.0</li> <li>★ Weight : 220g max</li> </ul>
<p>★ M4 screw is requested when mounting. Please check the instruction manual for the size of screw.</p>	

# Din rail Attachment Plate

## APPLICABLE TO MODEL

Din rail width : 35mm

Plate model	Model	screws for installation	
		Type	Qty
FD-A	R50A RMB30A, RMC30A	M3	2pcs
FD-B	MMC8A R10A, R15A, R25A RMB15A, RMC15A	M3	2pcs

## EXTERNAL VIEW

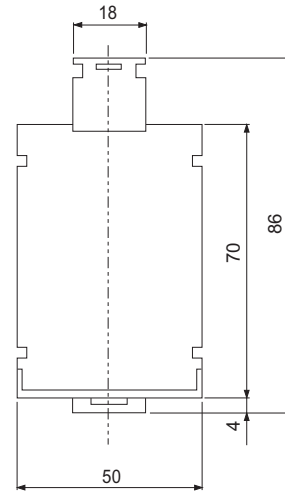
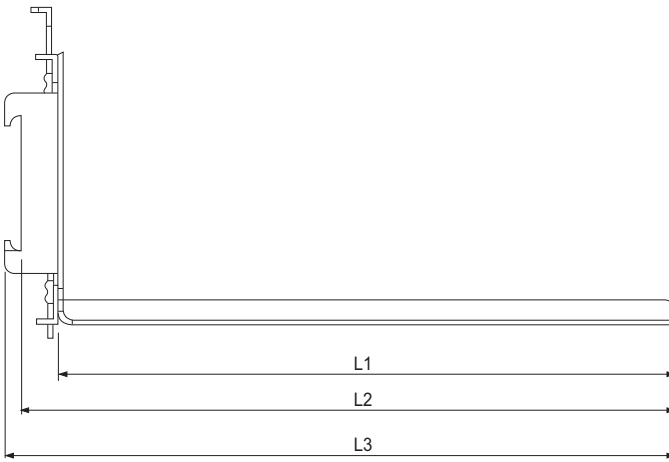

(Unit : mm)

Model	L1	L2	L3
FD-A	165	174.5	178.6
FD-B	115	124.5	128.6

- \* Material : SPCC
- \* Thickness : 1.6
- \* Tolerance : ±1
- \* Weight : FD-A 290g max  
FD-B 240g max

## DIN RAIL ATTACHMENT MODEL : FD-SP

## MOUNTING EXAMPLE

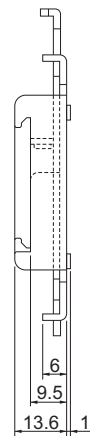
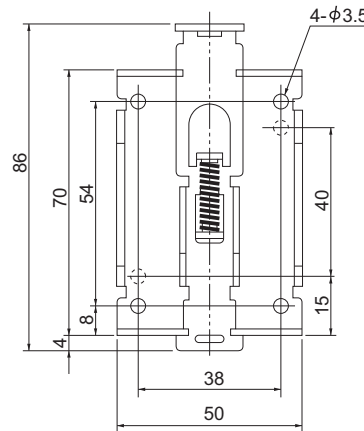
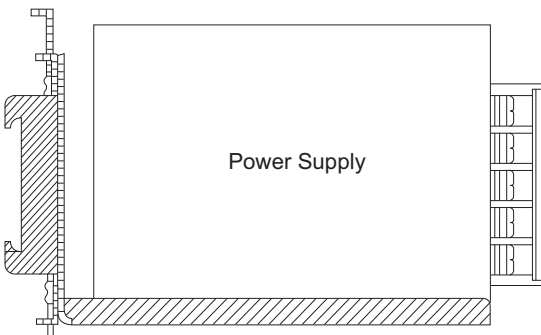

- \* Material : SPCC
- \* Thickness : 1.6
- \* Tolerance : ±1
- \* Weight : 85g max

Harness for input/output(J type) is prepared in R series.

R Series  
RMB Series  
RMC Series

Mating harness

Model	Harness model #	
	Input	Output
R10A · 15A · 25A · 50A	H-IN-3	H-OU-9
RMB15A · 30A · 50A		H-OU-16
RMC15A · 30A · 50A		H-OU-15

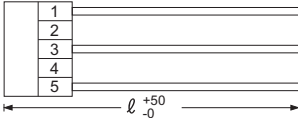
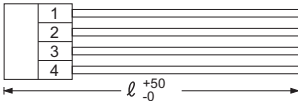
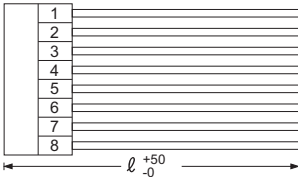
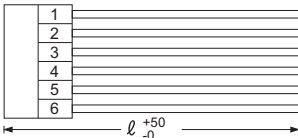
<p>●Model number <b>H-IN-3</b></p> <p>Housing : VHR-5N (J.S.T.) Pin : SVH-21T-P1.1 (J.S.T.) Weight : 20g max</p>	<p>●Type</p> 	<p>●Wire</p> <table border="1"> <thead> <tr> <th>Pin #</th> <th>Wire</th> <th>AWG</th> <th>Color</th> <th>Length ℓ (mm)</th> </tr> </thead> <tbody> <tr> <td>1</td> <td>UL1015</td> <td>20</td> <td>white</td> <td>500</td> </tr> <tr> <td>2</td> <td></td> <td></td> <td></td> <td></td> </tr> <tr> <td>3</td> <td>UL1015</td> <td>20</td> <td>black</td> <td>500</td> </tr> <tr> <td>4</td> <td></td> <td></td> <td></td> <td></td> </tr> <tr> <td>5</td> <td>UL1015</td> <td>20</td> <td>green</td> <td>500</td> </tr> </tbody> </table>	Pin #	Wire	AWG	Color	Length ℓ (mm)	1	UL1015	20	white	500	2					3	UL1015	20	black	500	4					5	UL1015	20	green	500															
Pin #	Wire	AWG	Color	Length ℓ (mm)																																											
1	UL1015	20	white	500																																											
2																																															
3	UL1015	20	black	500																																											
4																																															
5	UL1015	20	green	500																																											
<p>●Model number <b>H-OU-9</b></p> <p>Housing : VHR-4N (J.S.T.) Pin : SVH-21T-P1.1 (J.S.T.) Weight : 40g max</p>	<p>●Type</p> 	<p>●Wire</p> <table border="1"> <thead> <tr> <th>Pin #</th> <th>Wire</th> <th>AWG</th> <th>Color</th> <th>Length ℓ (mm)</th> </tr> </thead> <tbody> <tr> <td>1</td> <td>UL1015</td> <td>18</td> <td>black</td> <td>500</td> </tr> <tr> <td>2</td> <td>UL1015</td> <td>18</td> <td>black</td> <td>500</td> </tr> <tr> <td>3</td> <td>UL1015</td> <td>18</td> <td>red</td> <td>500</td> </tr> <tr> <td>4</td> <td>UL1015</td> <td>18</td> <td>red</td> <td>500</td> </tr> </tbody> </table>	Pin #	Wire	AWG	Color	Length ℓ (mm)	1	UL1015	18	black	500	2	UL1015	18	black	500	3	UL1015	18	red	500	4	UL1015	18	red	500																				
Pin #	Wire	AWG	Color	Length ℓ (mm)																																											
1	UL1015	18	black	500																																											
2	UL1015	18	black	500																																											
3	UL1015	18	red	500																																											
4	UL1015	18	red	500																																											
<p>●Model number <b>H-OU-15</b></p> <p>Housing : VHR-8N (J.S.T.) Pin : SVH-21T-P1.1 (J.S.T.) Weight : 80g max</p>	<p>●Type</p> 	<p>●Wire</p> <table border="1"> <thead> <tr> <th>Pin #</th> <th>Wire</th> <th>AWG</th> <th>Color</th> <th>Length ℓ (mm)</th> </tr> </thead> <tbody> <tr> <td>1</td> <td>UL1015</td> <td>18</td> <td>purple</td> <td>500</td> </tr> <tr> <td>2</td> <td>UL1015</td> <td>18</td> <td>gray</td> <td>500</td> </tr> <tr> <td>3</td> <td>UL1015</td> <td>18</td> <td>gray</td> <td>500</td> </tr> <tr> <td>4</td> <td>UL1015</td> <td>18</td> <td>orange</td> <td>500</td> </tr> <tr> <td>5</td> <td>UL1015</td> <td>18</td> <td>black</td> <td>500</td> </tr> <tr> <td>6</td> <td>UL1015</td> <td>18</td> <td>black</td> <td>500</td> </tr> <tr> <td>7</td> <td>UL1015</td> <td>18</td> <td>red</td> <td>500</td> </tr> <tr> <td>8</td> <td>UL1015</td> <td>18</td> <td>red</td> <td>500</td> </tr> </tbody> </table>	Pin #	Wire	AWG	Color	Length ℓ (mm)	1	UL1015	18	purple	500	2	UL1015	18	gray	500	3	UL1015	18	gray	500	4	UL1015	18	orange	500	5	UL1015	18	black	500	6	UL1015	18	black	500	7	UL1015	18	red	500	8	UL1015	18	red	500
Pin #	Wire	AWG	Color	Length ℓ (mm)																																											
1	UL1015	18	purple	500																																											
2	UL1015	18	gray	500																																											
3	UL1015	18	gray	500																																											
4	UL1015	18	orange	500																																											
5	UL1015	18	black	500																																											
6	UL1015	18	black	500																																											
7	UL1015	18	red	500																																											
8	UL1015	18	red	500																																											
<p>●Model number <b>H-OU-16</b></p> <p>Housing : VHR-6N (J.S.T.) Pin : SVH-21T-P1.1 (J.S.T.) Weight : 60g max</p>	<p>●Type</p> 	<p>●Wire</p> <table border="1"> <thead> <tr> <th>Pin #</th> <th>Wire</th> <th>AWG</th> <th>Color</th> <th>Length ℓ (mm)</th> </tr> </thead> <tbody> <tr> <td>1</td> <td>UL1015</td> <td>18</td> <td>gray</td> <td>500</td> </tr> <tr> <td>2</td> <td>UL1015</td> <td>18</td> <td>orange</td> <td>500</td> </tr> <tr> <td>3</td> <td>UL1015</td> <td>18</td> <td>black</td> <td>500</td> </tr> <tr> <td>4</td> <td>UL1015</td> <td>18</td> <td>black</td> <td>500</td> </tr> <tr> <td>5</td> <td>UL1015</td> <td>18</td> <td>red</td> <td>500</td> </tr> <tr> <td>6</td> <td>UL1015</td> <td>18</td> <td>red</td> <td>500</td> </tr> </tbody> </table>	Pin #	Wire	AWG	Color	Length ℓ (mm)	1	UL1015	18	gray	500	2	UL1015	18	orange	500	3	UL1015	18	black	500	4	UL1015	18	black	500	5	UL1015	18	red	500	6	UL1015	18	red	500										
Pin #	Wire	AWG	Color	Length ℓ (mm)																																											
1	UL1015	18	gray	500																																											
2	UL1015	18	orange	500																																											
3	UL1015	18	black	500																																											
4	UL1015	18	black	500																																											
5	UL1015	18	red	500																																											
6	UL1015	18	red	500																																											