

EAP-03-472 / ESP-03-472

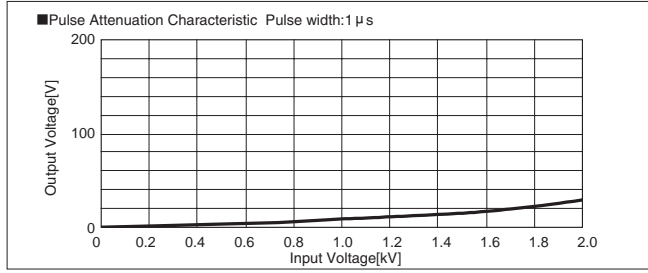

EAP-06-472 / ESP-06-472

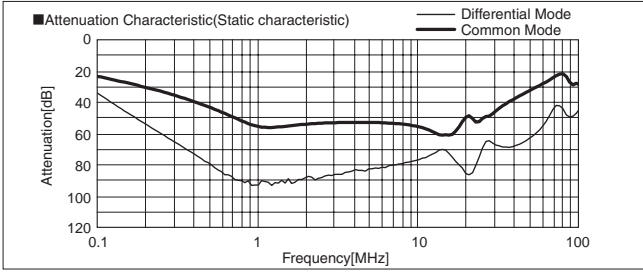
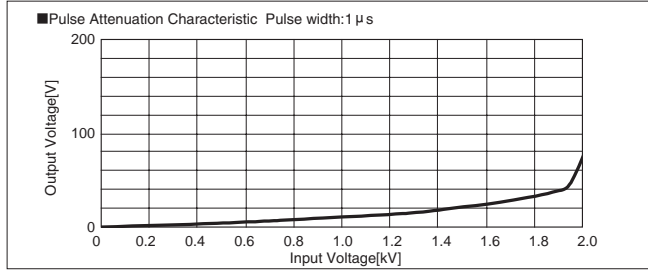
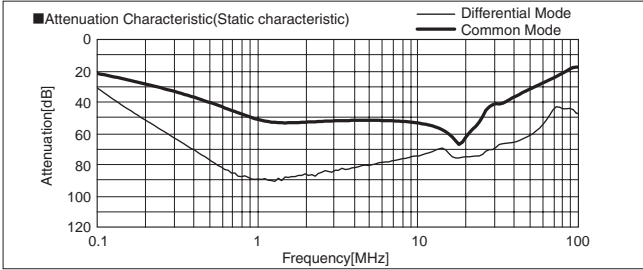

EAP-10-472 / ESP-10-472

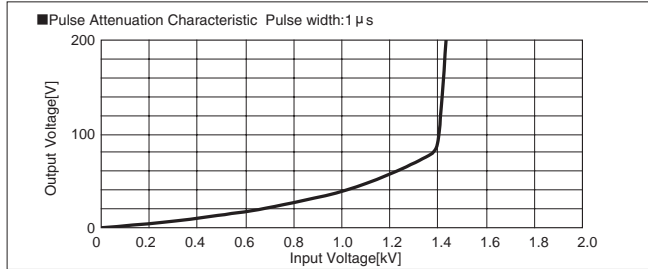
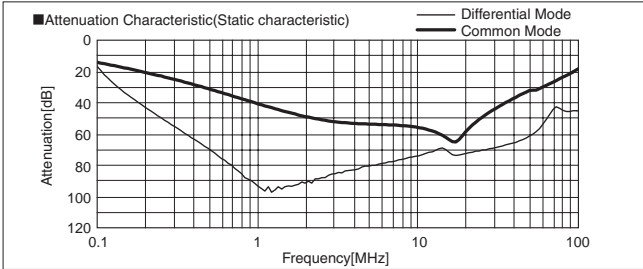

EAP-16-472 / ESP-16-472

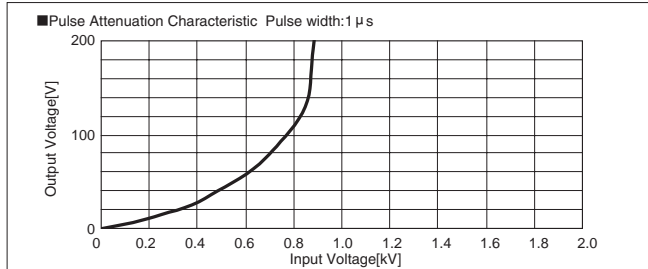
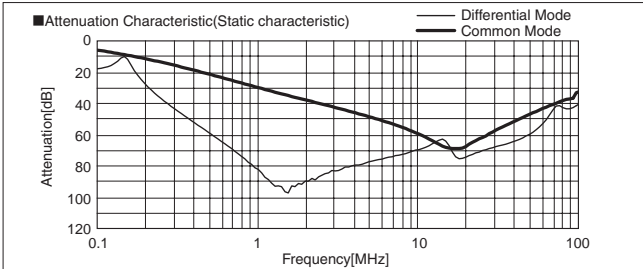

EAP-20-472

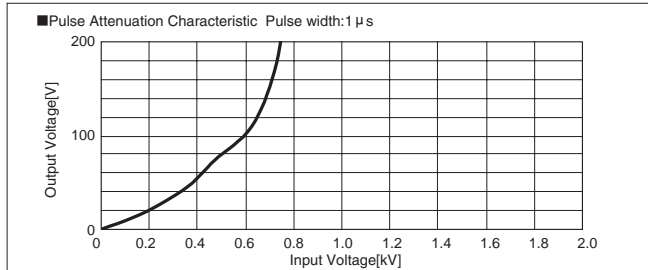
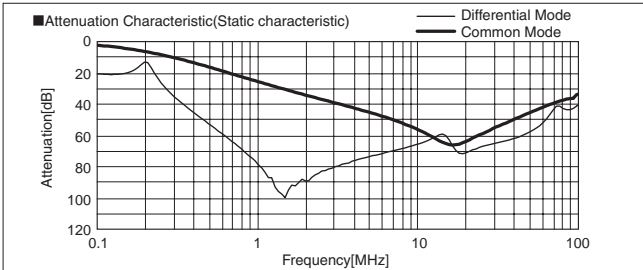

EAP-30-472

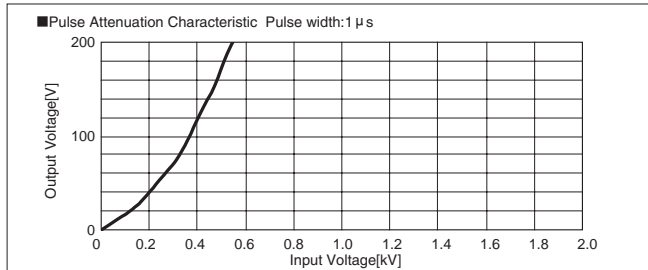
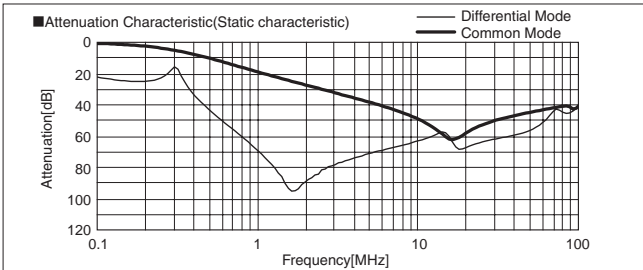

1 Applicable Electric Cable

- Only use the electric cable that exists in the Table1.
- Use the cable that conductor material is copper. Do not use the cable that conductor material is iron or aluminum. Never use the one other than the electric cable.
Ex. Steel wire, Stick made of resin, other wire
- Note that the current rating is different in each electric cable.
- Strip so as not to damage the conductor at stripping sheath.
- Strip specified length of cable sheath (Refer to Table1).
Strip Length can be confirmed with a gauge of the body case. Refer to External view.
- Do not put solder on the conductor. It becomes impossible to connect cable.

Table.1 Applicable Wire

Solid wire	Diameter 0.5mm to 1.2mm (AWG.22 to AWG.16)
Stranded wire	0.3mm ² to 1.25mm ² (AWG.22 to AWG.16) Conductor diameter more than 0.18 mm
Sheath strip length	10mm to 12mm

2 Applicable bar-type terminal

- The applicable bar-type terminal (Refer to Table 2) must be used, and after crimp, the size of bar-type terminal must be kept value of Table 3. Use the applicable terminal (Refer to Table 2) and keep the size of terminal, or you will not be able to connect cable. Contact us when the bar-type terminals other than the applicable bar-type terminal (Refer to Table 2) are used.
- Connect cable so as not to conceal the button with the sleeve of the cable when a round terminals other than the applicable terminal are used.

Table.2 Applicable bar-type terminal

Manufacturer	Size	model	Crimp tool
Phoenix Contact	AWG.22	AI0.34-12TQ	CRIMPFOX UD6-4
	AWG.20	AI0.5-10WH AI0.5-12WH	
	AWG.18	AI0.75-10GY AI0.75-12GY	
		AI1-10RD AI1-12RD	
AWG.16	AI1.5-10BK AI1.5-12BK		
Nichifu	AWG.22-16	TGN TC-1.25-11T	NH11 NH32 NH65
		TGV TC-1.25-11T	

<Square type>

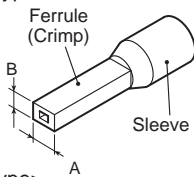

<Round type>

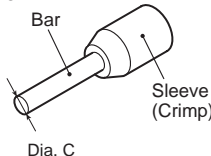
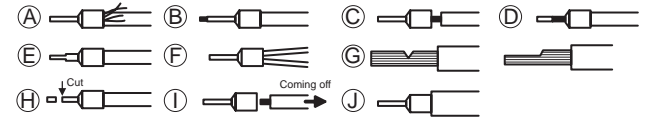

Table.3 Dimension of terminal at crimp
[Dimensions in mm]

Part	Dimension
A	1.1 to 2.6
B	0.8 to 1.6
Dia. C	0.8 to 1.6

3 State of crimped bar-type terminal

● Bad condition



- Ⓐ The wire protrudes from the sleeve.
- Ⓑ The conductor extremely protrudes from the point of the bar-type terminal.
- Ⓒ The electric conductor is not inserted enough and the conductor has been exposed from the terminal.
- Ⓓ The sheath strip length doesn't suffice and the conductor is not enough inserted in the ferrules.
- Ⓔ Crimp is only the point of conductor.
- Ⓕ It crimps two electric cables.
- Ⓖ There is a damage or a disconnection part in the conductor.
- Ⓗ The point of the terminal is cut.
- Ⓘ It comes off the terminal when the cable is pulled.
- ⓵ The sheath of the cable protrudes from the sleeve.

4 Wiring Terminal Blocks (connecting/releasing)

- One electric cable one insertion hole. When two or more is connected, it causes trouble.
- Do connecting and releasing of the electric cable by using a flat-blade driver while pushing the connection/release button. Moreover, insert the conductor or the bar-type terminal to the end fully.
- When you connect the stranded cable, connect wires after lightly stranding wires.
- Confirm the electric cable is surely connected with the terminal after connecting.
- The check hole can be used for the check of wire connecting and insulation and for the operation monitor etc.

● Connecting : Stranded cable, Solid cable (Diameter 0.5 to 0.9)

- StepI Push the button with a flat-blade driver.
- StepII Insert the cable into the hole while pushing the button.
- StepIII Release the flat-blade driver and cable connection is completion.

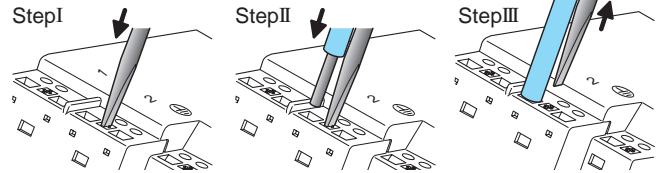

● Connecting : Solid wire (except diameter 0.5 to 0.9), bar type terminal

- Insert the cable into the insertion hole.
* Insert it while pushing the button when it is not easy to insert it.

● Releasing : Stranded wire, Solid wire, bar type terminal

- Pull out the electric cable while pushing the button with flat-blade driver.

- * Notice : Two insertion holes are released at the same time by pushing the button once. (Except PE terminal)

- Use the flat-blade driver that meets the size in Table 4.

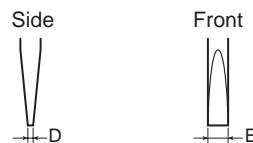
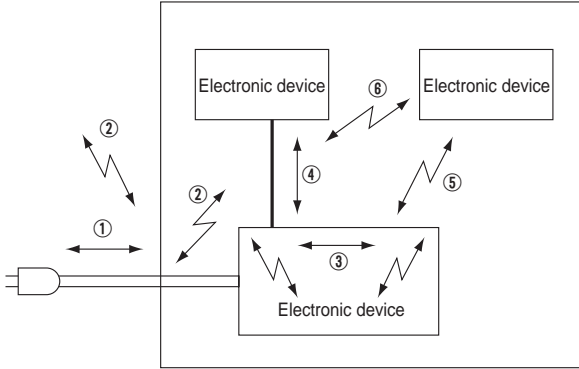

Table.4 Dimension of flat-blade driver
[Dimensions in mm]

Part	Dimension
D	1.0max
E	3.0max

1 Noise Transmission



Noise transmission between electric power and electronic device

- ① Conducted noise from electric power lines.
- ② Radiated noise which is picked up and generated by the power line as antenna.
- ③ Conducted and radiated noise which is generated in the electronic device.
- ④ Conducted noise which is generated by the signal lines between electronic devices.
- ⑤ Radiated noise emitted an electronic device that interferes with other device.
- ⑥ Radiated noise which is picked up and generated by the signal line as antenna.

2 Application Precautions

The following points should be kept in mind to use the EMI/EMC Filter more effectively.

- Input wire and output wire of the EMI/EMC Filter should be separated.

When the input/output wire are bundled together or wired parallel with each other, high frequency noise is induced so, and the expected effect of noise attenuation cannot be achieved.

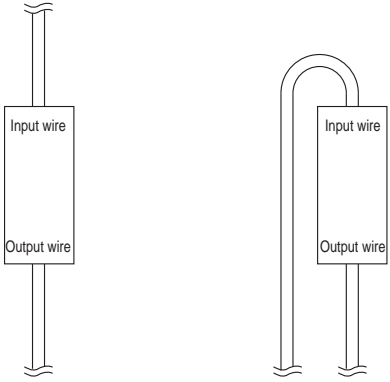

Good wiring example

Bad wiring example

- Ground lines should be as short as possible. If it is not, an equivalent inductance appears, and the high frequency attenuation characteristics degrade. When grounding the mounting plate of the EMI/EMC Filter, you should remove the paint to reduce the contact resistance from the equipment case, and then install the EMI/EMC Filter.

3 Method of measuring characteristic data

※ Attenuation = $20\log(U_{01}/U_{02})$ (dB)
 U_{01} : Voltage in state without filters
 U_{02} : Voltage in state which added filters
 ※ N.A.: Network analyzer

(1) Attenuation Characteristic(Static characteristic)

Object product: Single phase input type

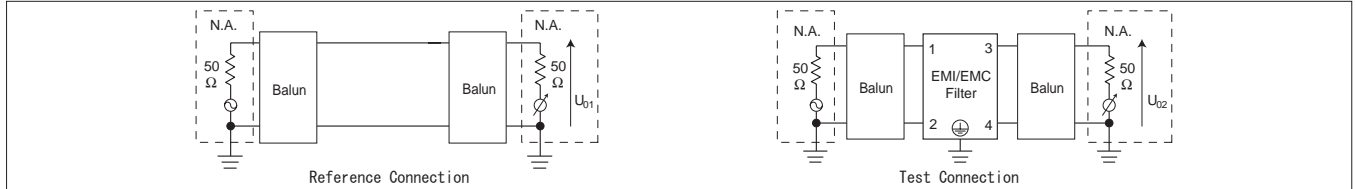

Fig.3.1 Differential mode attenuation measurement diagram

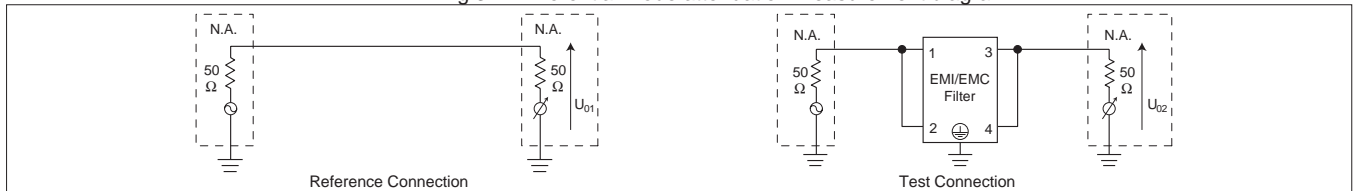

Fig.3.2 Common mode attenuation measurement diagram

Object product: Three phase input type

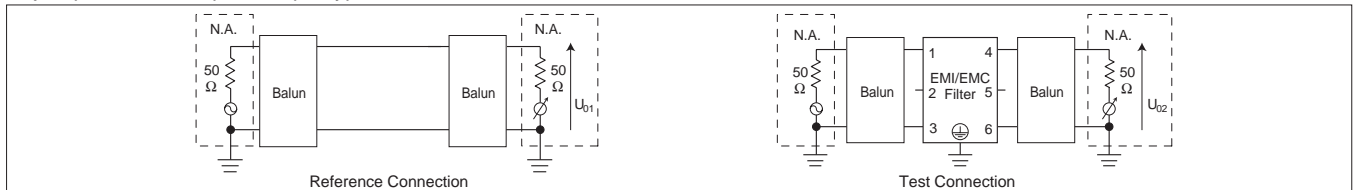

Fig.3.3 Differential mode attenuation measurement diagram

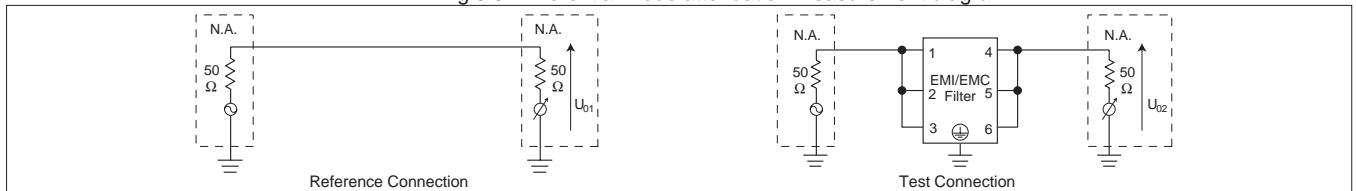

Fig.3.4 Common mode attenuation measurement diagram

Object product: DC input type

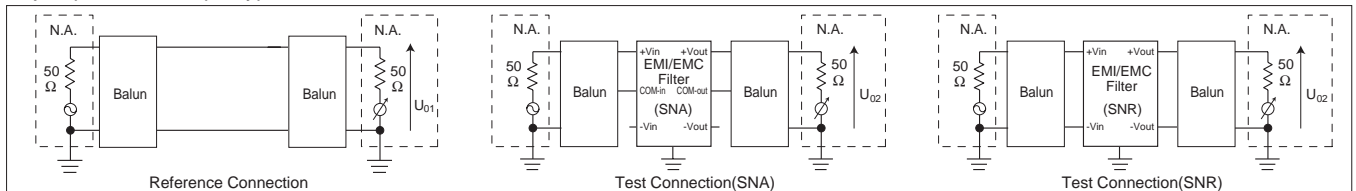

Fig.3.5 Differential mode attenuation measurement diagram

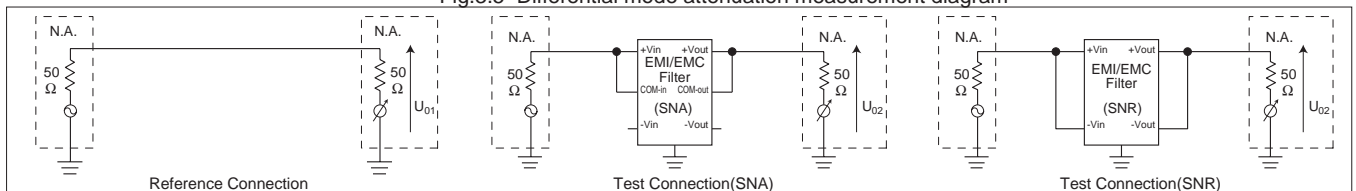

Fig.3.6 Common mode attenuation measurement diagram

(2) Pulse Attenuation Characteristic

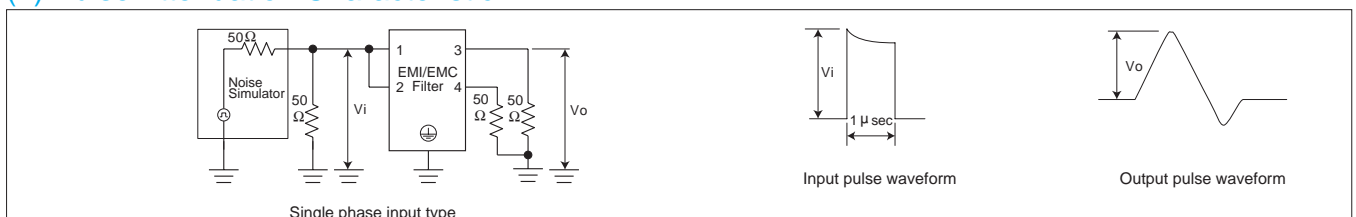

Fig.3.7 Pulse attenuation measurement diagram