

Basic Characteristics Data

Model	Circuit method	Switching frequency [kHz]	Input current	Rated input fuse	Inrush current protection	PCB/Pattern			Series/Redundancy operation availability	
						Material	Single sided	Double sided	Series operation	Redundancy operation
CHS60	Foward converter	440	*1	-	-	glass fabric base, epoxy resin		Multilayer	Yes	*2
CHS80	Half-bridge converter	250	*1	-	-	glass fabric base, epoxy resin		Multilayer	Yes	*2
CHS120	Half-bridge converter	200	*1	-	-	glass fabric base, epoxy resin		Multilayer	Yes	*2
CHS200	Full-bridge converter	150	*1	-	-	glass fabric base, epoxy resin		Multilayer	Yes	*2
CHS300	Full-bridge converter	170	*1	-	-	glass fabric base, epoxy resin		Multilayer	Yes	*2
CHS400	Full-bridge converter	150	*1	-	-	glass fabric base, epoxy resin		Multilayer	Yes	*2
CHS500	Full-bridge converter	150	*1	-	-	glass fabric base, epoxy resin		Multilayer	Yes	*2

*1 Refer to Specification.

*2 Refer to Instruction Manual.

1	Pin Connection	CHS-22
2	Connection for Standard Use	CHS-22
3	Wiring Input/Output Pin	CHS-23
3.1	Wiring input pin	CHS-23
3.2	Wiring output pin	CHS-23
4	Function	CHS-24
4.1	Overcurrent protection	CHS-24
4.2	Overvoltage protection	CHS-24
4.3	Thermal protection	CHS-24
4.4	Remote ON/OFF	CHS-24
4.5	Remote sensing	CHS-24
4.6	Adjustable voltage range	CHS-25
4.7	Isolation	CHS-26
4.8	PMBus interface	CHS-26
5	Series and Parallel Operation	CHS-26
5.1	Series operation	CHS-26
5.2	Parallel operation	CHS-26
5.3	Redundancy operation	CHS-27
6	Implementation · Mounting Method	CHS-27
6.1	Mounting method	CHS-27
6.2	Automatic Mounting (CHS series:option S)	CHS-28
6.3	Soldering	CHS-28
6.4	Stress onto the pins	CHS-28
6.5	Cleaning	CHS-29
6.6	Storage method (CHS series:option S)	CHS-29
6.7	Stress to the product	CHS-29
7	Safety Considerations	CHS-29
8	Derating	CHS-29
8.1	CHS Derating	CHS-29
9	SMD type(optionS) package information	CHS-34

1 Pin Connection

●CHS60

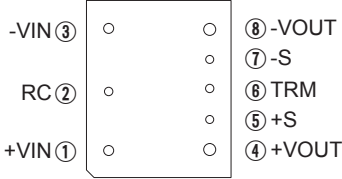

●CHS80

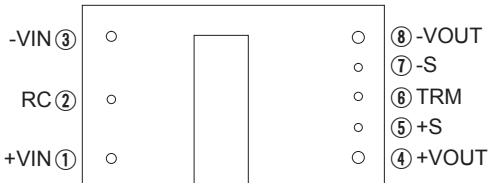

●CHS120

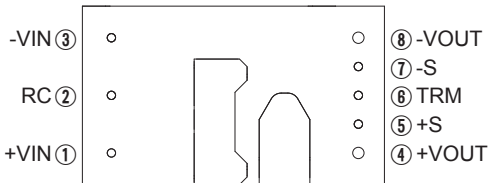

●CHS200

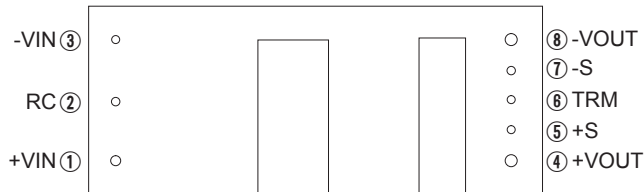

●CHS300

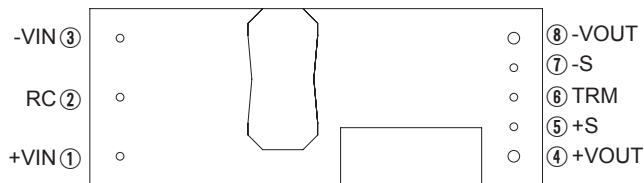

●CHS400/CHS500

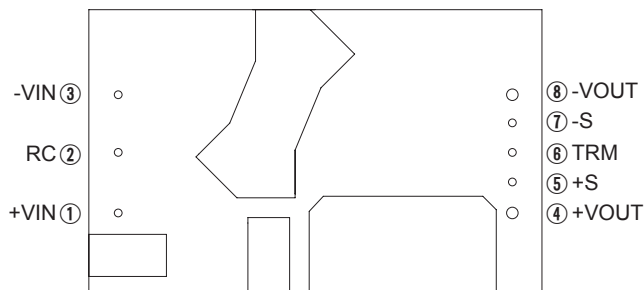

Fig.1.1 Pin Connection (bottom view)

Table 1.1 Pin Connection and function

No.	Pin Connection	Function
①	+VIN	+DC input
②	RC	Remote ON/OFF
③	-VIN	-DC input
④	+VOUT	+DC output
⑤	+S	+Remote sensing
⑥	TRM	Adjustment of output voltage
⑦	-S	-Remote sensing
⑧	-VOUT	-DC output

No.	Pin Connection	Reference
①	+VIN	3.1 "Wiring input pin "
②	RC	4.4 "Remote ON/OFF "
③	-VIN	3.1 "Wiring input pin "
④	+VOUT	3.2 "Wiring output pin "
⑤	+S	4.5 "Remote sensing "
⑥	TRM	4.6 "Adjustable voltage range "
⑦	-S	4.5 "Remote sensing "
⑧	-VOUT	3.2 "Wiring output pin "

2 Connection for Standard Use

■ In order to use the power supply, it is necessary to wire as shown in Fig.2.1.

{ Reference : 3 "Wiring Input/Output Pin"
8 "Derating" }

■ Short the following pins to turn on the power supply.

-VIN↔RC, +VOUT↔+S, -VOUT↔-S

{ Reference : 4.4 "Remote ON/OFF"
4.5 "Remote sensing" }

■ The CHS series handle only the DC input.

Avoid applying AC input directly.

It will damage the power supply.

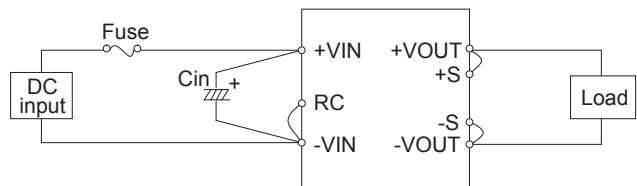

Cin : External capacitor on the input side

Fig.2.1 Connection for standard use

Table 2.1 Recommended External capacitor on the input side

Model	CHS30024			
Cin	660 μ F or more			
Model	CHS6048	CHS8048	CHS12048	CHS20048
Cin	66 μ F or more	33 μ F or more	47 μ F or more	100 μ F or more
Model	CHS30048/CHS40048/CHS50048			
Cin	200 μ F or more			

3 Wiring Input/Output Pin

3.1 Wiring input pin

(1) External fuse

- Fuse is not built-in on input side. In order to protect the unit, install the normal-blow type fuse on input side.
- When the input voltage from a front end unit is supplied to multiple units, install the normal-blow type fuse in each unit.

Table 3.1 Recommended fuse (Normal-blow type)

Model	CHS30024		
Rated current	20A		
Model	CHS6048	CHS8048	CHS12048
Rated current	5A	7A	10A
Model	CHS20048/CHS30048	CHS40048	CHS50048
Rated current	15A	20A	30A

(2) External capacitor on the input side

- Install an external capacitor C_{in} , between +VIN and -VIN input pins for low line-noise and for stable operation of the power supply.

Capacitance	Refer to Table 2.1
$T_a = -20$ to $+85^\circ\text{C}$	Electrolytic or Ceramic capacitor
$T_a = -40$ to $+85^\circ\text{C}$	Ceramic capacitor

- C_{in} is within 50mm for pins. Make sure that ripple current of C_{in} is less than its rating.

(3) Recommendation for noise-filter

- Install an external input filter as shown in Fig.3.1 in order to reduce conducted noise. C_{in} is shown in Table 2.1.

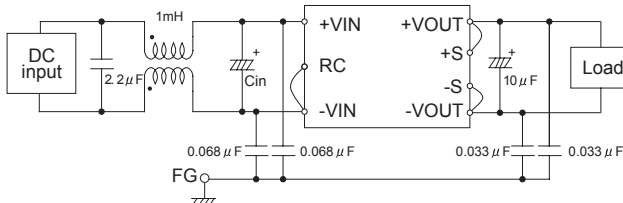

Fig.3.1 Recommended external input filter

(4) Reverse input voltage protection

- Avoid the reverse polarity input voltage. It will damage the power supply.

It is possible to protect the unit from the reverse input voltage by installing an external diode as shown in Fig.3.2.

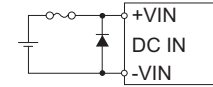

Fig.3.2 Reverse input voltage protection

3.2 Wiring output pin

- When the CHS series supplies the pulse current for the pulse load, please install a capacitor C_o between +VOUT and -VOUT pins. Recommended capacitance of C_o is shown in Table 3.2, 3.3.
- If output current decreases rapidly, output voltage rises transiently and the overvoltage protection circuit may operate. In this case, please install a capacitor C_o .
- Select a high frequency type capacitor. Output ripple and startup waveform may be influenced by ESR-ESL of the capacitor and the wiring impedance.
- Make sure that ripple current of C_o is than its rating.

 Table 3.2 Recommended capacitance C_o (CHS60, CHS80, CHS120)

No.	Output voltage	CHS60	CHS80	CHS120
1	3.3V	0 - 20,000 μ F	0 - 20,000 μ F	0 - 20,000 μ F
2	5V	0 - 10,000 μ F	0 - 10,000 μ F	0 - 10,000 μ F
3	12V	0 - 2,200 μ F	0 - 1,000 μ F	0 - 2,200 μ F

 Table 3.3 Recommended capacitance C_o (CHS200, CHS300, CHS400, CHS500)

No.	Output voltage	CHS200	CHS300	CHS400/CHS500
1	3.3V	0 - 40,000 μ F	—	—
2	5V	0 - 20,000 μ F	0 - 20,000 μ F	—
3	10V	—	0 - 2,200 μ F	0 - 4,000 μ F
4	12V	0 - 2,200 μ F	0 - 2,200 μ F	0 - 4,000 μ F
5	15V	—	0 - 2,200 μ F	—

- Ripple and Ripple Noise are measured, as shown in the Fig.3.3. C_{in} is shown in Table 2.1.

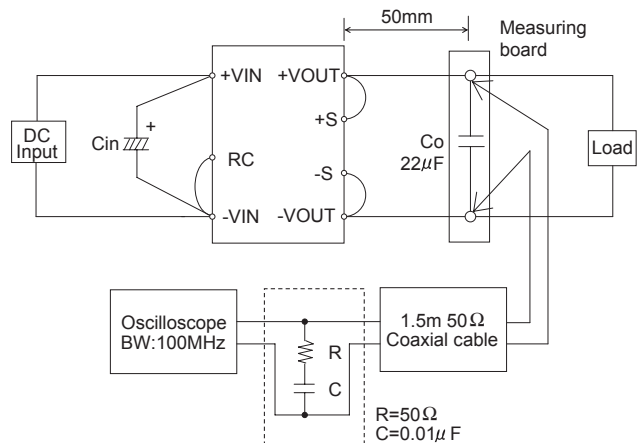

Fig.3.3 Measuring method of Ripple and Ripple Noise

4 Function

4.1 Overcurrent protection

Over Current Protection (OCP) is built-in and works at 105% of the rated current or higher. However, use in an overcurrent situation must be avoided whenever possible.

The output voltage of the power module will recover automatically when the fault causing overcurrent is corrected.

When the output voltage drops after OCP works, the power module enters a "hiccup mode" where it repeatedly turns on and off at a certain frequency.

4.2 Overvoltage protection

The overvoltage protection circuit is built-in. The DC input will be shut down if overvoltage protection is in operation.

The output voltage of the power module will recover automatically when the fault causing over voltage is corrected.

Remarks :

Please note that devices inside the power supply might fail when voltage more than rated output voltage is applied to output pin of the power supply. This could happen when the customer tests the overvoltage performance of the unit.

4.3 Thermal protection

When the power supply temperature is kept above 120°C, the thermal protection will be activated and simultaneously shut down the output.

The output voltage of the power supply will recover automatically when the unit is cool down.

●-U

Option "-U" means output is shut down when the abovementioned protection circuit is activated.

If this happens, protection circuit can be inactivated by cycling the DC input power off for at least 1 second or toggling Remote ON/OFF signal.

4.4 Remote ON/OFF

Remote ON/OFF circuit is built-in on the input side (RC).

The ground pin of input side remote ON/OFF circuit is "-VIN" pin.

Table 4.1.1 Specification of Remote ON/OFF(CHS80,CHS200)

	ON/OFF logic	Between RC and -VIN	Output voltage
Standard	Negative	L level(0 - 0.8V) or short	ON
		H level(2.0 - 7.0V) or open	OFF
Optional -R	Positive	L level(0 - 0.8V) or short	OFF
		H level(2.0 - 7.0V) or open	ON

When RC is "Low" level, fan out current is 0.1mA typ. When Vcc is applied, use $2.0 \leq V_{cc} \leq 7.0V$.

Table 4.1.2 Specification of Remote ON/OFF(CHS60,CHS120,CHS300,CHS400,CHS500)

	ON/OFF logic	Between RC and -VIN	Output voltage
Standard	Negative	L level(0 - 0.8V) or short	ON
		H level(4.0 - 7.0V) or open	OFF
Optional -R	Positive	L level(0 - 0.8V) or short	OFF
		H level(4.0 - 7.0V) or open	ON

When RC is "Low" level, fan out current is 0.1mA typ. When Vcc is applied, use $4.0 \leq V_{cc} \leq 7.0V$.

When remote ON/OFF function is not used, please short between RC and -VIN (-R: open between RC and -VIN).

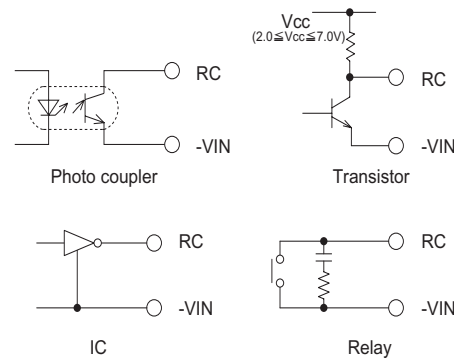

Fig.4.1 RC connection example

4.5 Remote sensing

(1) When the remote sensing function is not in use

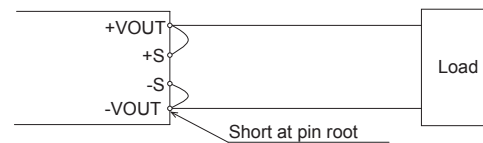

Fig.4.2 Connection when the remote sensing is not in use

When the remote sensing function is not in use, it is necessary to confirm that pins are shorted between +S & +VOUT and between -S & -VOUT.

Wire between +S & +VOUT and between -S & -VOUT as short as possible.

Loop wiring should be avoided.

This power supply might become unstable by the noise coming from poor wiring.

(2)When the remote sensing function is in use

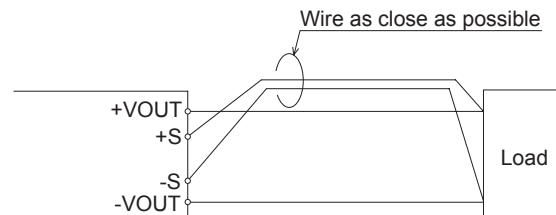

Fig.4.3 Connection when the remote sensing is in use

Twisted-pair wire or shield wire should be used for sensing wire.

Thick wire should be used for wiring between the power supply and a load.

Line drop should be less than 0.3V.

Voltage between +VOUT and -VOUT should remain within the output voltage adjustment range.

■ If the sensing patterns are short, heavy-current is drawn and the pattern may be damaged.

The pattern disconnection can be prevented by installing the protection parts as close as possible to a load.

■ Output voltage might become unstable because of impedance of wiring and load condition when length of wire exceeds 40cm.

4.6 Adjustable voltage range

(1) To adjust output voltage

- Output voltage is adjustable by the external potentiometer.
- When the output voltage adjustment is used, note that the over voltage protection circuit operates when the output voltage is set too high.
- If the output voltage drops under the output voltage adjustment range, the Low voltage protection operates.
- By connecting the external potentiometer (VR1) and resistors (R1, R2), output voltage becomes adjustable, as shown in Fig.4.4. Recommended external parts are shown in Table 4.2.
- The wiring to the potentiometer should be as short as possible. The temperature coefficient could become worse, depending on the type of a resistor and potentiometer. Following parts are recommended for the power supply.
 Resistor.....Metal film type, coefficient of less than ±100ppm/°C
 Potentiometer....Cermet type, coefficient of less than ±300ppm/°C
- When the output voltage adjustment is not used, open the TRM pin respectively.
- The change speed of the TRM voltage should be less than 0.15V/ms, when changing output voltage to less than 90% of the rated.

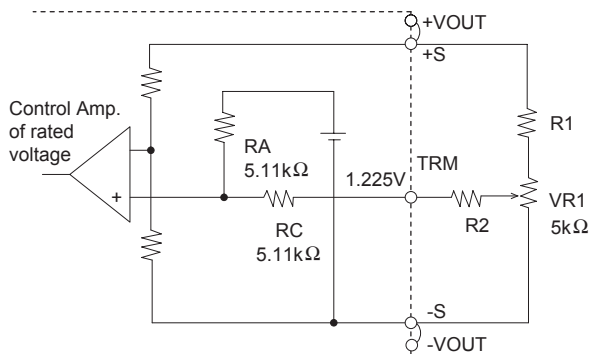

Fig.4.4 Output voltage control circuit

Table 4.2 Recommended value of external potentiometer & resistor

No.	VOUT	Output adjustable range					
		VOUT ±5%			VOUT ±10%		
		R1	R2	VR1	R1	R2	VR1
1	3.3V	2.2kΩ	68kΩ	5kΩ	2.2kΩ	33kΩ	5kΩ
2	5V	4.7kΩ	68kΩ		5.6kΩ	33kΩ	
3	10V	15kΩ	68kΩ		15kΩ	33kΩ	
4	12V	18kΩ	68kΩ		18kΩ	33kΩ	
5	15V	22kΩ	68kΩ		22kΩ	33kΩ	

(2) To decrease output voltage

■ By connecting the external resistor (RD), output voltage becomes adjustable to decrease.

The external resistor (RD) is calculated by the following equation.

$$RD = \frac{5.11}{\Delta} - 10.22 \text{ [k}\Omega\text{]}$$

$$\Delta = \frac{V_{OR} - V_{OD}}{V_{OR}}$$

V_{OR} : Rated output voltage [V]

V_{OD} : Output voltage needed to set up [V]

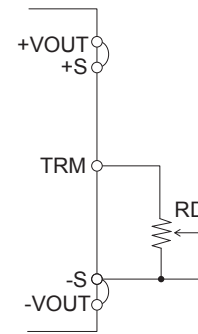

Fig.4.5 Connection to decrease output voltage

(3) To increase output voltage

■ By connecting the external resistor (RU), output voltage becomes adjustable to increase.

The external resistor (RU) is calculated by the following equation.

$$RU = \frac{5.11 \times V_{OR} \times (1 + \Delta)}{1.225 \times \Delta} - \frac{5.11}{\Delta} - 10.22 \text{ [k}\Omega\text{]}$$

$$\Delta = \frac{V_{OU} - V_{OR}}{V_{OR}}$$

V_{OR} : Rated output voltage [V]

V_{OU} : Output voltage needed to set up [V]

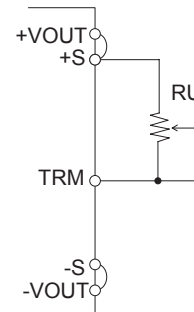

Fig.4.6 Connection to increase output voltage

(4) Input voltage derating

■ When input voltage is 18-21.5V DC or 36-44VDC, the output voltage adjustment range becomes as shown in Fig.4.7.

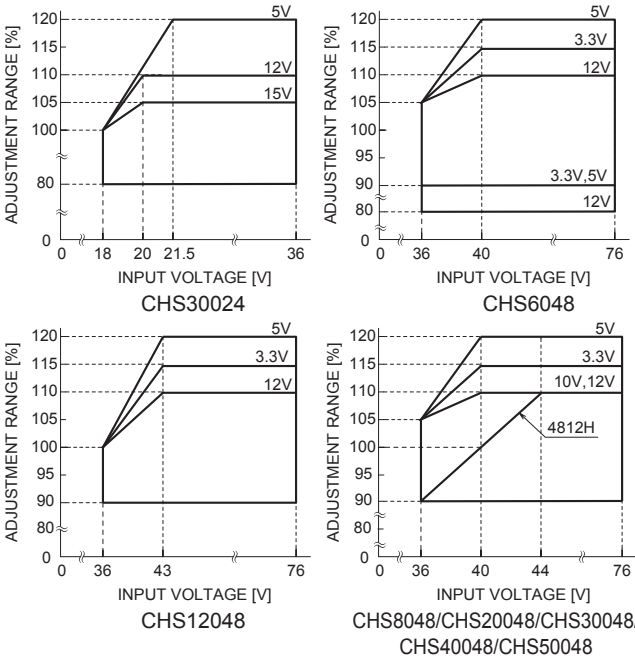

Fig.4.7 CHS Output Voltage Adjustment Range

4.7 Isolation

■ For a receiving inspection, such as Hi-Pot test, gradually increase (decrease) the voltage to start (shut down). Avoid using Hi-Pot tester with timer because it may generate voltage a few times higher than the applied voltage at ON/OFF of a timer.

4.8 PMBus interface

●-I (CHS300/CHS400)

■ This option is equipped with a digital PMBus interface. Please contact us about for details.

5 Series and Parallel Operation

5.1 Series operation

■ Series operation is available by connecting the outputs of two or more power supplies, as shown below. Output current in series connection should be lower than the lowest rated current in each unit.

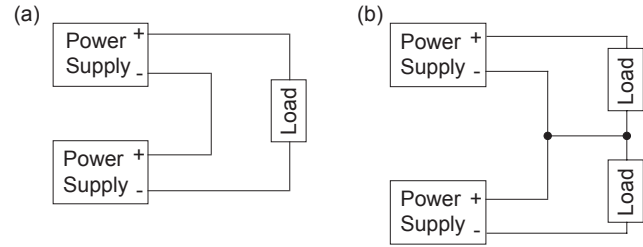

Fig.5.1 Examples of series operation

5.2 Parallel operation

●-P (CHS400/CHS500)

■ This option is for parallel operation.

■ Sensing and adjustment of the output voltage are not possible at the time of the use with this option.

■ As variance of output current drew from each power supply is maximum 10%, the total output current must not exceed the value determined by the following equation.

(Output current in parallel operation)

$$= (\text{the rated current per unit}) \times (\text{number of unit}) \times 0.9$$

When the number of units in parallel operation increases, input current increase at the same time. Adequate wiring design for input circuitry is required, such as circuit pattern, wiring and current capacity for equipment.

■ Total number of units should be no more than 3 pieces.

■ Thick wire should be used for wiring between the power supply and load, and line drop should be less than 0.3V.

■ Connect each input pin for the lowest possible impedance.

■ When the number of the units in parallel operation increases, input current increases. Adequate wiring design for input circuitry such as circuit pattern, wiring and current for equipment is required.

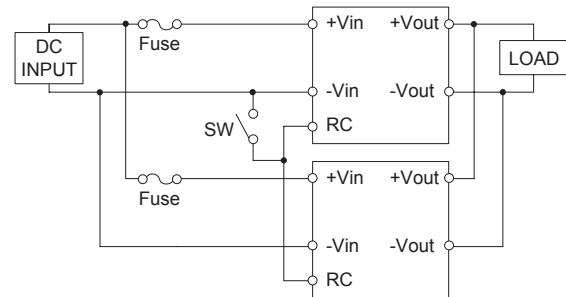

Fig.5.2 Examples of parallel operation

5.3 Redundancy operation

- Parallel operation is not possible.
- Redundancy operation is available by wiring as shown below.

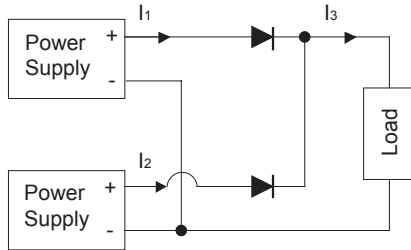

Fig.5.3 Redundancy operation

- Even a slight difference in output voltage can affect the balance between the values of I_1 and I_2 .
- Please make sure that the value of I_3 does not exceed the rated current of the power supply.

$$I_3 \leq \text{the rated current value}$$

6 Implementation · Mounting Method

6.1 Mounting method

- The unit can be mounted in any direction. When two or more power supplies are used side by side, position them with proper intervals to allow enough air ventilation. The temperature around each power supply should not exceed the temperature range shown in derating curve.
- Avoid placing the DC input line pattern layout underneath the unit. It will increase the line conducted noise. Make sure to leave an ample distance between the line pattern layout and the unit. Also avoid placing the DC output line pattern underneath the unit because it may increase the output noise. Lay out the pattern away from the unit.
- Avoid placing the signal line pattern layout underneath the unit because the power supply might become unstable. Lay out the pattern away from the unit.
- Avoid placing pattern layout in hatched area shown in Fig.6.1 to insulate between pattern and power supply.

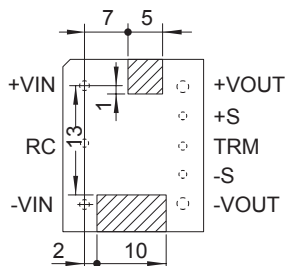

(a) CHS60

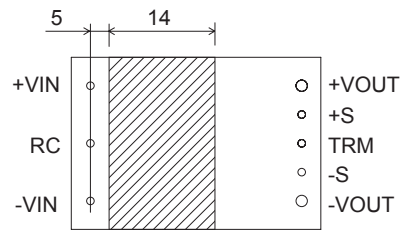

(b) CHS80

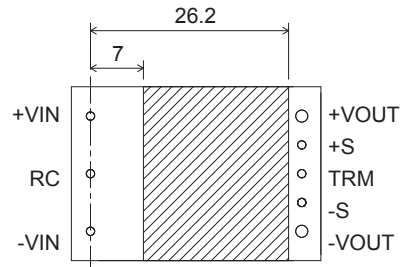

(c) CHS120

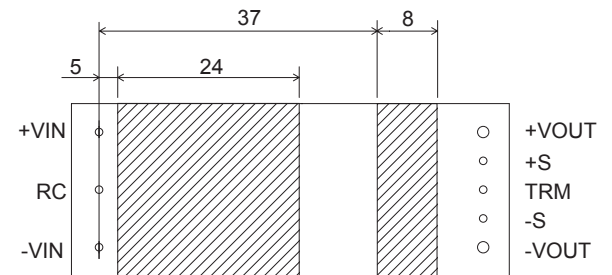

(d) CHS200

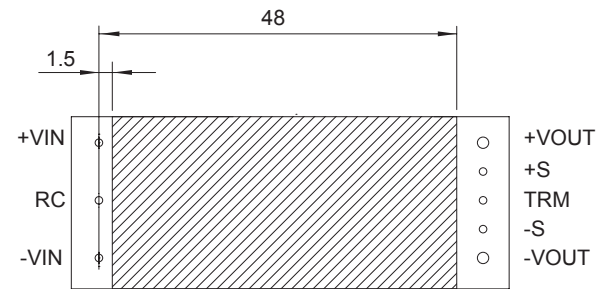

(e) CHS300

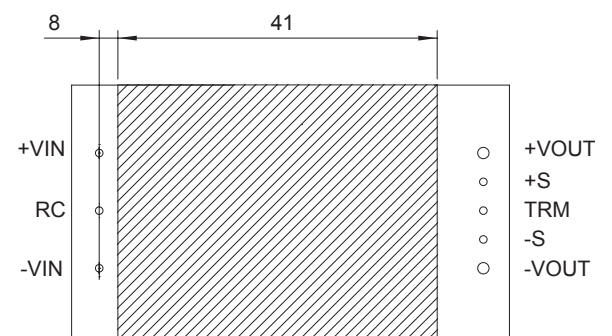

(f) CHS400

Dimensions in mm

Fig.6.1 Prohibition area of pattern layout (top view)

6.2 Automatic Mounting (CHS series:option S)

■To mount CHS series automatically, use the inductor area near the output pin as an adsorption point. Please see the External View for details of the adsorption point.

If the bottom dead point of a suction nozzle is too low when mounting excessive force is applied to the inductor, it could cause damage. Please mount carefully.

6.3 Soldering

(1)Flow Soldering :260°C 15 seconds or less

(2)Soldering Iron :maximum 450°C 5 seconds or less

(3)Reflow Soldering (option “-S”)

■Fig.6.2 shows conditions for the reflow soldering for option “-S” of CHS series. Please make sure that the temperatures of pin terminals +VIN and -VOUT shown in Fig.6.2 do not exceed the temperatures shown in Fig.6.3.

■If time or temperature of the reflow soldering goes beyond the conditions, reliability of internal components may be compromised. Please use the unit under the recommended reflow conditions.

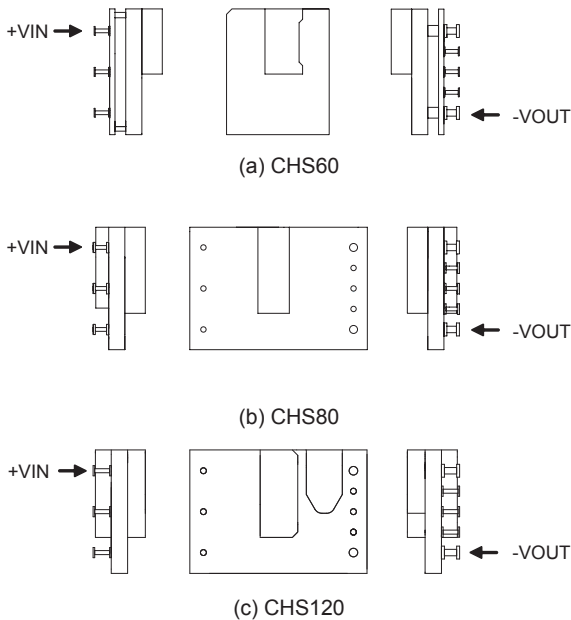
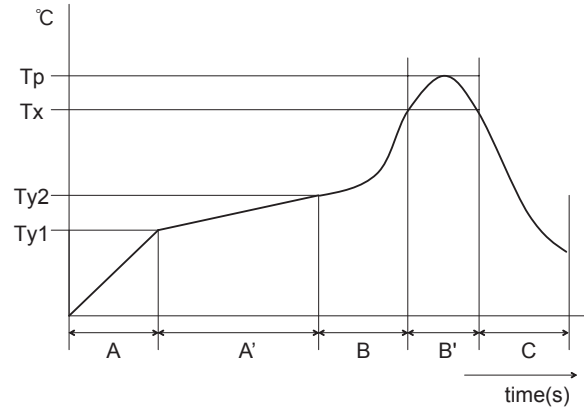

Fig.6.2 Temperature Measuring Points when Setting Reflow Soldering Conditions



A	1.0 - 5.0°C/s
A'	Ty1:160±10°C Ty2:180±10°C Ty1 - Ty2:120s max
B	1.0 - 5.0°C/s
B'	Tp:Max245°C 10s max Tx:220°C or more:70s max
C	1.0 - 5.0°C/s

Fig.6.3 Recommend Reflow Soldering Conditions

●Notes to use option “-S”

■Solder iron or other similar methods are not recommended soldering method for option “-S” because it may not be able to retain connection reliability between the PCB and the Pins. Solder reflow is the acceptable mounting system for the option.

■Option “-S” is not reusable product after soldered on any application PCB.

6.4 Stress to the pins

■When too much stress is applied to the pins of the power supply, the internal connection may be weakened.

As shown in Fig.6.4, avoid applying stress of more than 19.6N (2kgf) to the pins horizontally and more than 39.2N (4kgf) vertically.

■The pins are soldered on PWB internally. Therefore, do not pull or bend them with strong force.

■Fix the unit on PCB (using silicone rubber or fixing fittings) to reduce the stress to the pins.

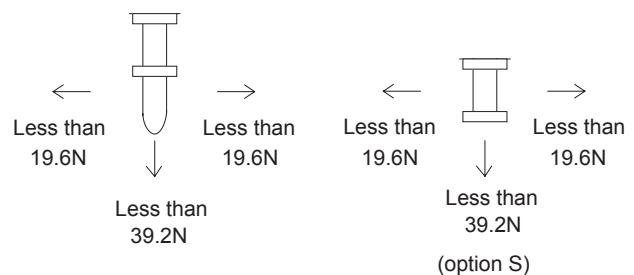

Fig.6.4 Stress to the pins

6.5 Cleaning

- When cleaning is necessary, clean under the following conditions.
 - Method : Varnishing, ultrasonic wave and vapor
 - Cleaning agents : IPA (Solvent type)
 - Total time : 2 minutes or less
- Do not apply pressure to the lead and name plate with a brush or scratch it during the cleaning.
- After cleaning, dry them enough.

6.6 Storage method (CHS series:option S)

- To stock unpacked products in your inventory, it is recommended to keep them under controlled condition, 5-30°C, 60%RH and use them within a year.
- 24-hour baking is recommended at 125°C, if unpacked products were kept under uncontrolled condition, which is 30°C, 60%RH or higher.
 - Original trays are not heat-resistant. Please move them to heat-resistant trays in preparation to bake.
 - To check moisture condition in the pack. Silica gel packet has some moisture condition indicator particles.
 - Indicated blue means good. Pink means alarm to bake it.
- Notification. The tray will be deformed and the power supply might be damaged, if the vacuum pressure is too much to reseal.

6.7 Stress to the product

- CHS series transformer core and choke coil core are attached by glue.
 - There is a possibility that the core will be removed and power supply will be damaged when they receive stress by the fall or some kind of stress.

7 Safety Considerations

- To apply for safety standard approval using this power supply, the following conditions must be met.
- This unit must be used as a component of the end-use equipment.
- The equipment must contain basic insulation between input and output. If double or reinforced insulation is required, it has to be provided by the end-use equipment in accordance with the final build-in condition.
- Safety approved fuse must be externally installed on input side.

8 Derating

- It is necessary to note thermal fatigue life by power cycle.
 - Please reduce the temperature fluctuation range as much as possible when the up and down of temperature are frequently generated.

8.1 CHS Derating

- Use with the convection cooling or the forced air cooling.
 - Make sure the temperatures at temperature measurement locations shown from Fig.8.2.1 to Fig.8.2.10 below are on or under the derating curve in Fig.8.1.
 - Ambient temperature must be kept at 85°C or under.

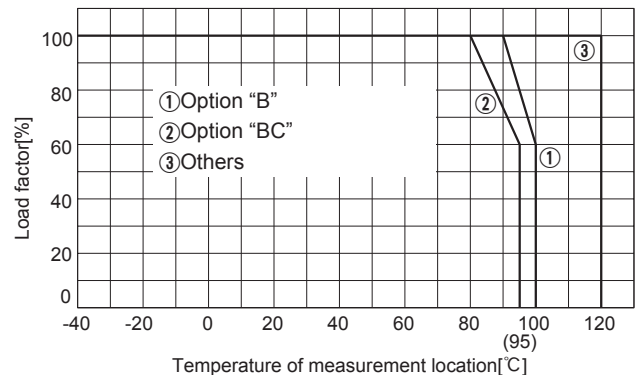

(a) CHS60, CHS80, CHS200, CHS300, CHS400, CHS500

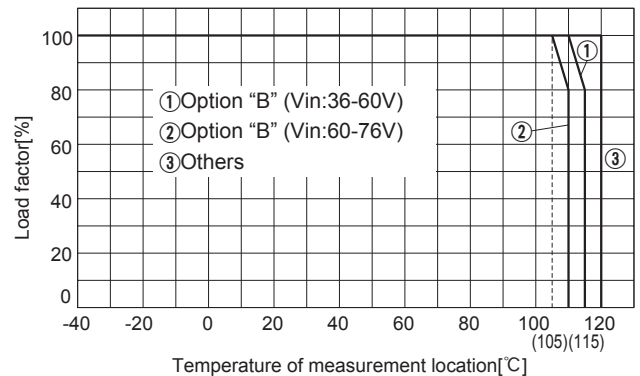

(b) CHS120

Fig.8.1 Derating curve

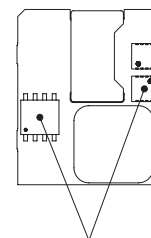

Temperature measurement location

Fig.8.2.1 Temperature measurement location (CHS60)

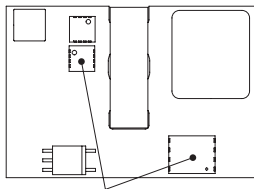

Temperature measurement location

Fig.8.2.2 Temperature measurement location (CHS80)

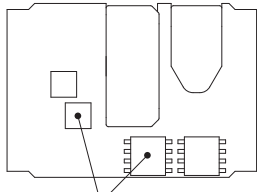

Temperature measurement location

Fig.8.2.3 Temperature measurement location (CHS120)

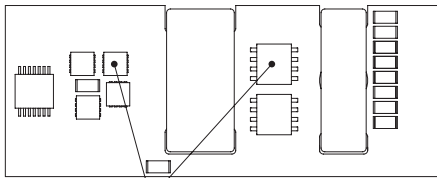

Temperature measurement location

Fig.8.2.4 Temperature measurement location (CHS200)

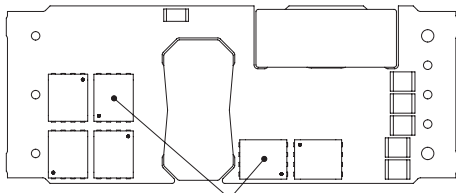

Temperature measurement location

Fig.8.2.5 Temperature measurement location (CHS300)

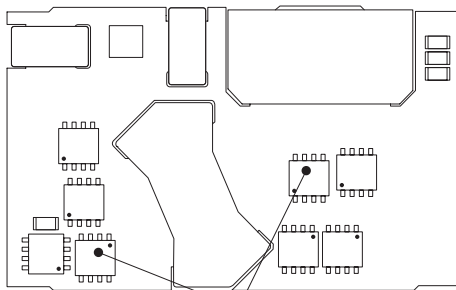

Temperature measurement location

Fig.8.2.6 Temperature measurement location (CHS400)

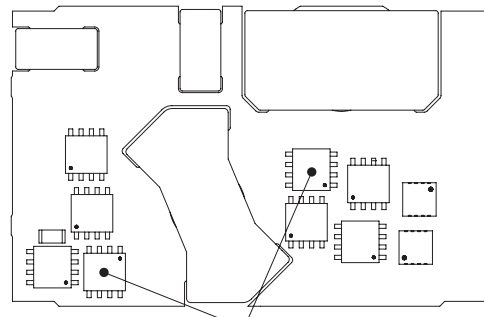

Temperature measurement location

Fig.8.2.7 Temperature measurement location (CHS500)

■ For option "B" which is used with the convection cooling, forced air cooling or conduction cooling, use the temperature measurement location as shown in Fig.8.2.8 to Fig.8.2.10.

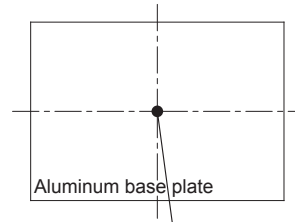

Measurement point

Fig.8.2.8 Measurement point (CHS120 option "B")

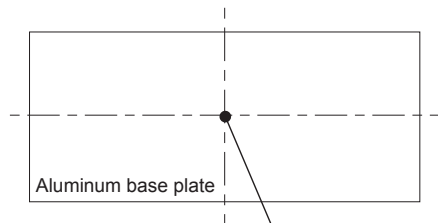

Measurement point

Fig.8.2.9 Measurement point (CHS200/CHS300 option "B" and "BC")

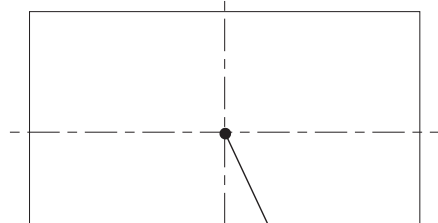

Measurement point

Fig.8.2.10 Measurement point (CHS400/CHS500 option "B")

■ Shown the thermal curve with measuring as shown in Fig.8.3. Verify final design by actual temperature measurement. Use the temperature measurement location as shown in Fig.8.2.1 to Fig.8.2.7 at 120°C or less.

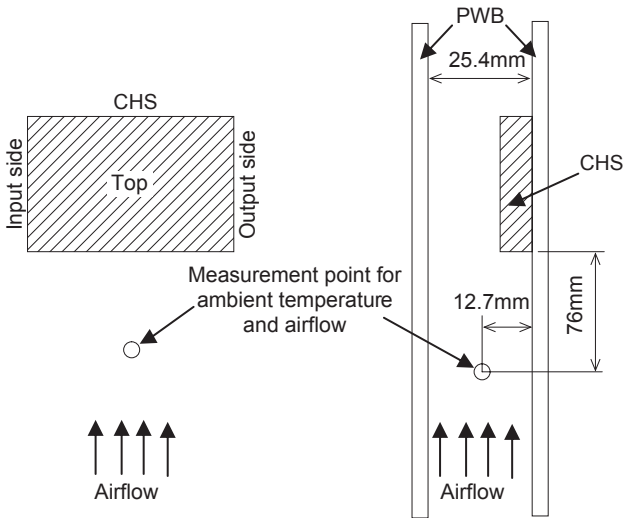

Fig.8.3 Measuring method

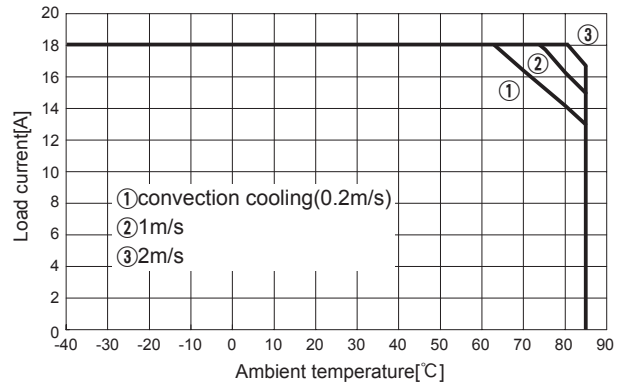

Fig.8.4 Load current vs. ambient temperature(CHS60483R3 Vin=48V)

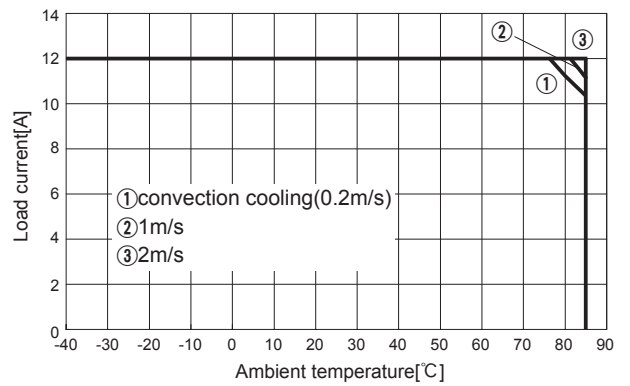

Fig.8.5 Load current vs. ambient temperature(CHS604805 Vin=48V)

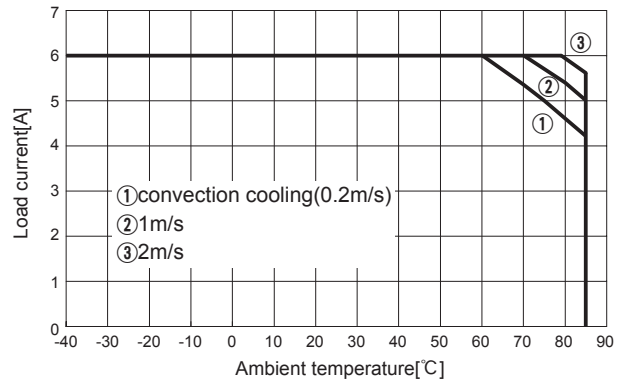

Fig.8.6 Load current vs. ambient temperature(CHS604812 Vin=48V)

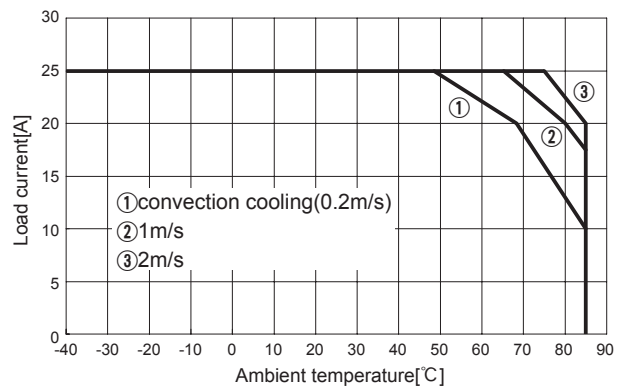

Fig.8.7 Load current vs. ambient temperature(CHS80483R3 Vin=48V)

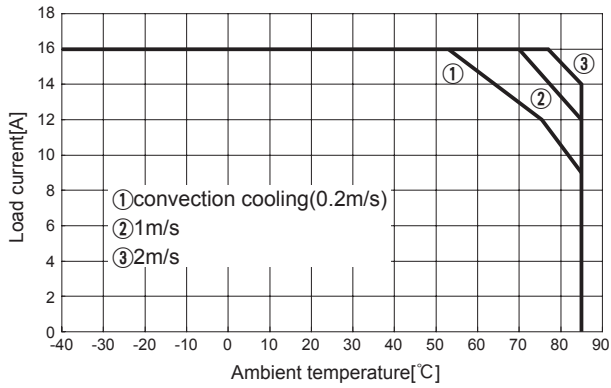

Fig.8.8 Load current vs. ambient temperature(CHS804805 Vin=48V)

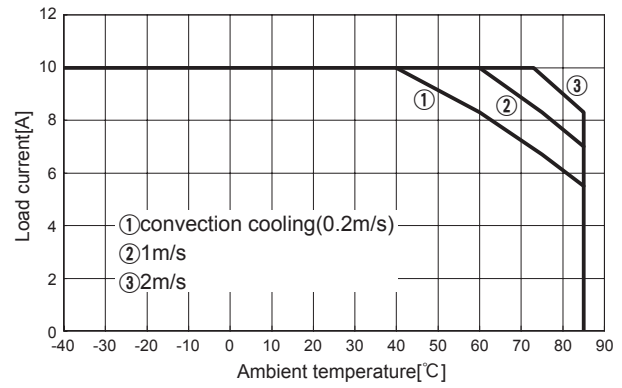

Fig.8.12 Load current vs. ambient temperature(CHS1204812 Vin=48V)

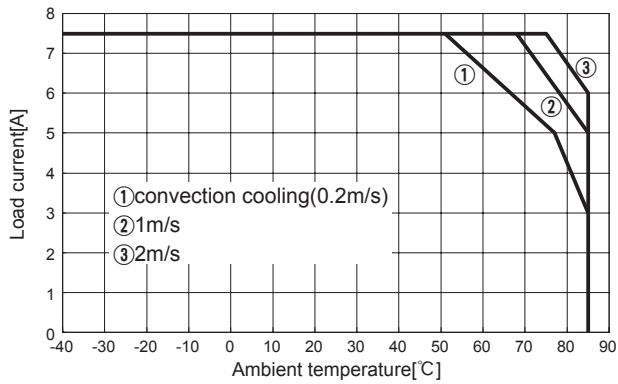

Fig.8.9 Load current vs. ambient temperature(CHS804812 Vin=48V)

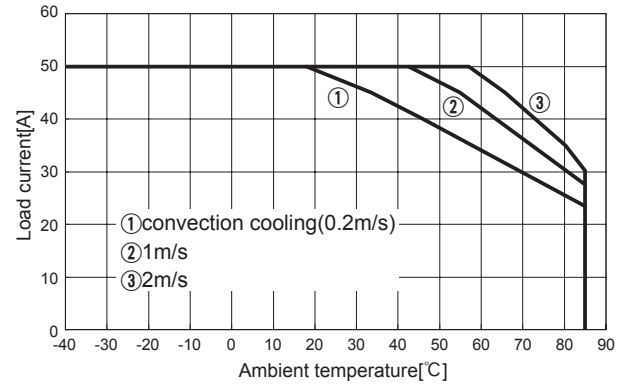

Fig.8.13 Load current vs. ambient temperature(CHS200483R3 Vin=48V)

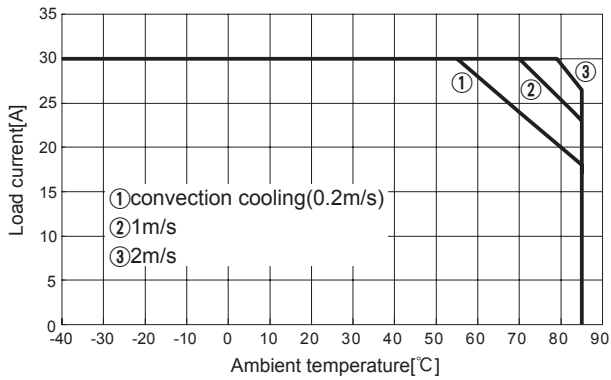

Fig.8.10 Load current vs. ambient temperature(CHS120483R3 Vin=48V)

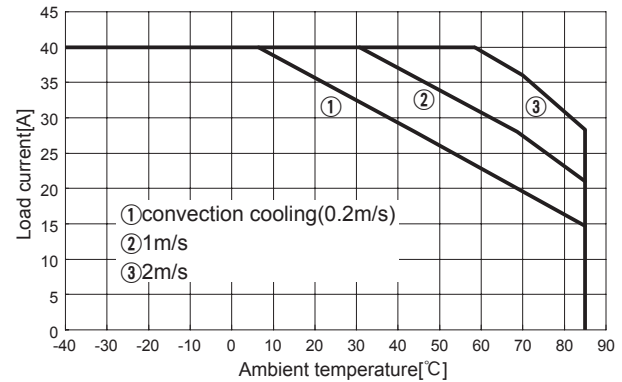

Fig.8.14 Load current vs. ambient temperature(CHS2004805 Vin=48V)

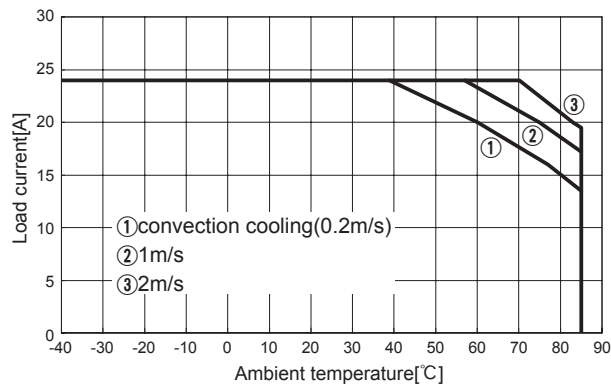

Fig.8.11 Load current vs. ambient temperature(CHS1204805 Vin=48V)

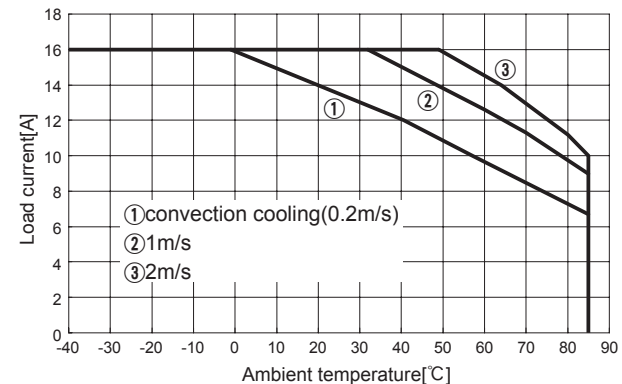

Fig.8.15 Load current vs. ambient temperature(CHS2004812 Vin=48V)

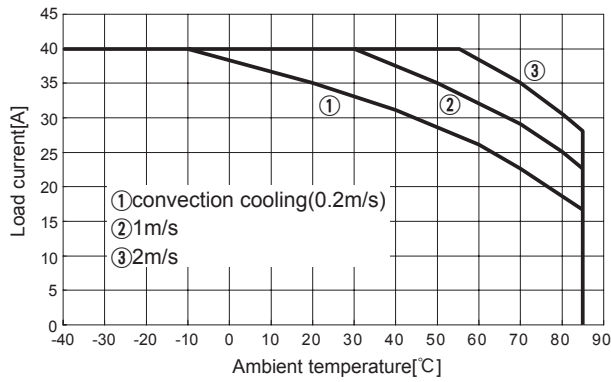

Fig.8.16 Load current vs. ambient temperature(CHS3002405 Vin=24V)

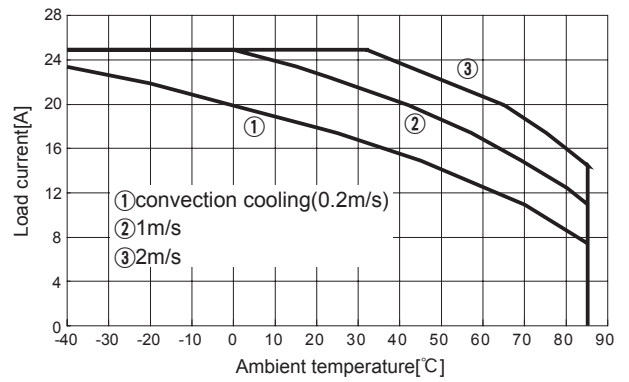

Fig.8.20 Load current vs. ambient temperature(CHS3004812 Vin=48V)

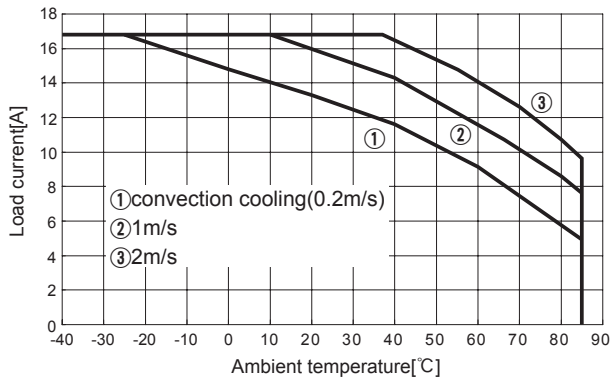

Fig.8.17 Load current vs. ambient temperature(CHS3002412 Vin=24V)

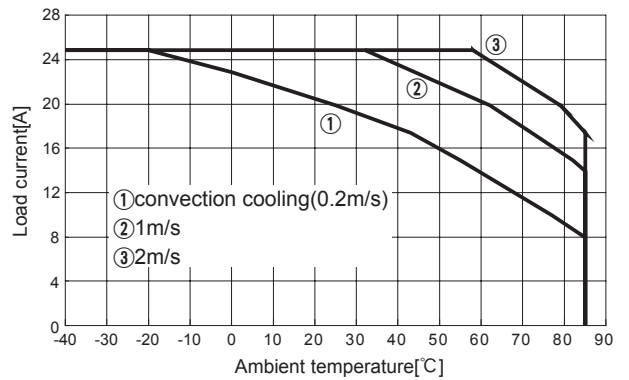

Fig.8.21 Load current vs. ambient temperature(CHS3004812H Vin=48V)

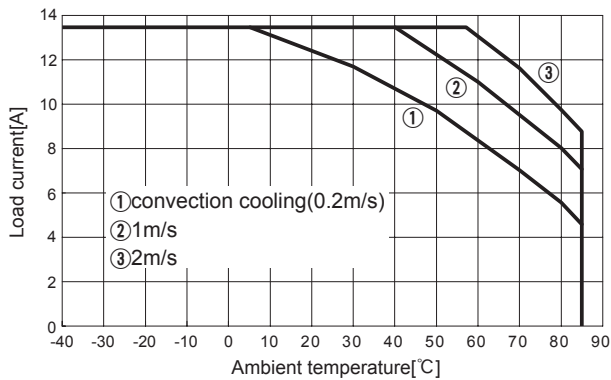

Fig.8.18 Load current vs. ambient temperature(CHS3002415 Vin=24V)

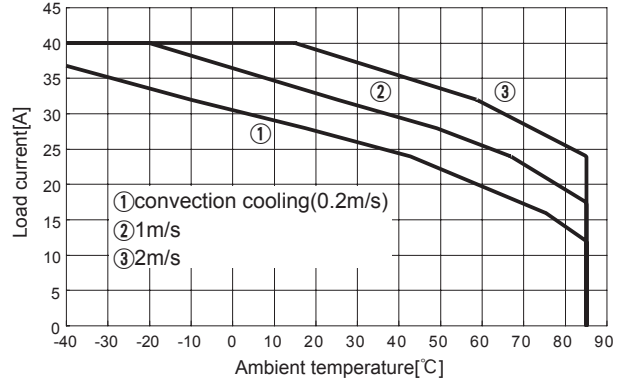

Fig.8.22 Load current vs. ambient temperature(CHS4004810 Vin=48V)

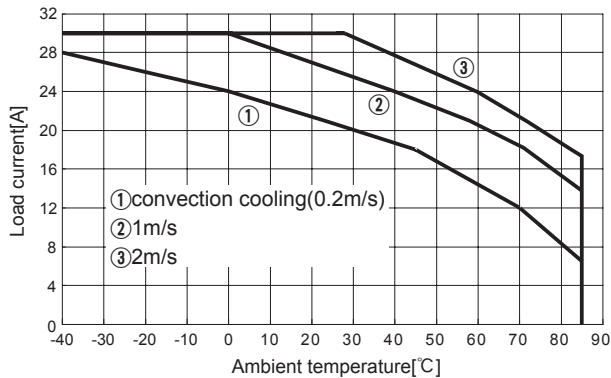

Fig.8.19 Load current vs. ambient temperature(CHS3004810 Vin=48V)

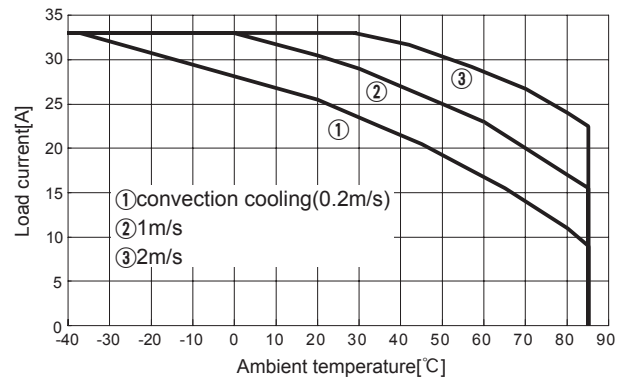

Fig.8.23 Load current vs. ambient temperature(CHS4004812 Vin=48V)

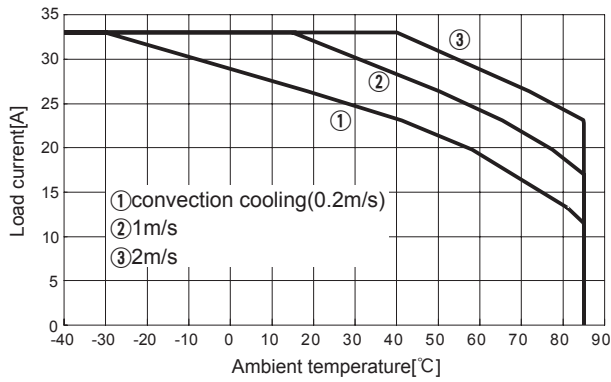

Fig.8.24 Load current vs. ambient temperature(CHS4004812H Vin=48V)

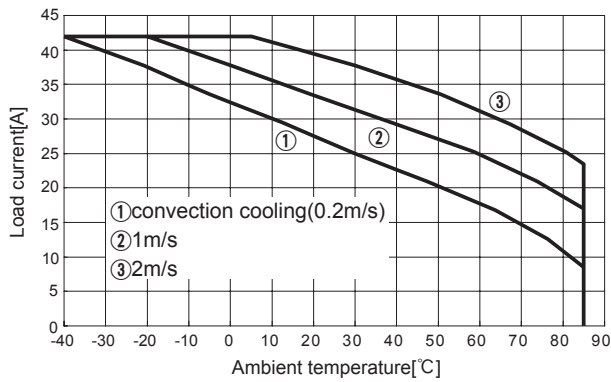

Fig.8.25 Load current vs. ambient temperature(CHS5004812 Vin=48V)

9 SMD type(option S) package information

■ These are packed in a tray (Fig.9.1 to Fig.9.3).

Please order “CHS60□□-S”, “CHS80□□-S”, “CHS120□□-S” for tray type packaging.

Capacity of the tray is 15max.

In case of fractions, the units are stored in numerical order.

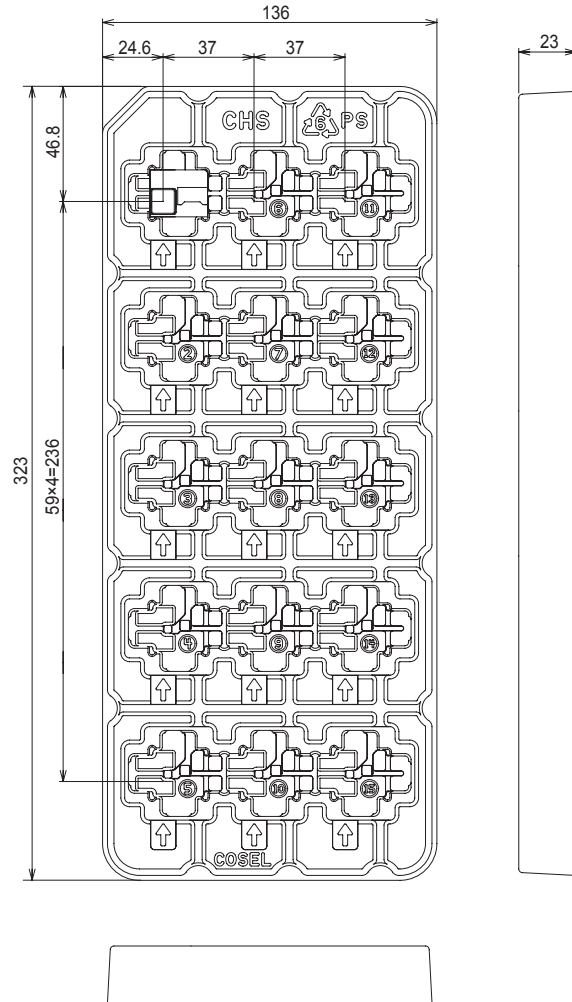

Dimensions in mm

Material : Conductive PS

Fig.9.1 Delivery package information (CHS60)

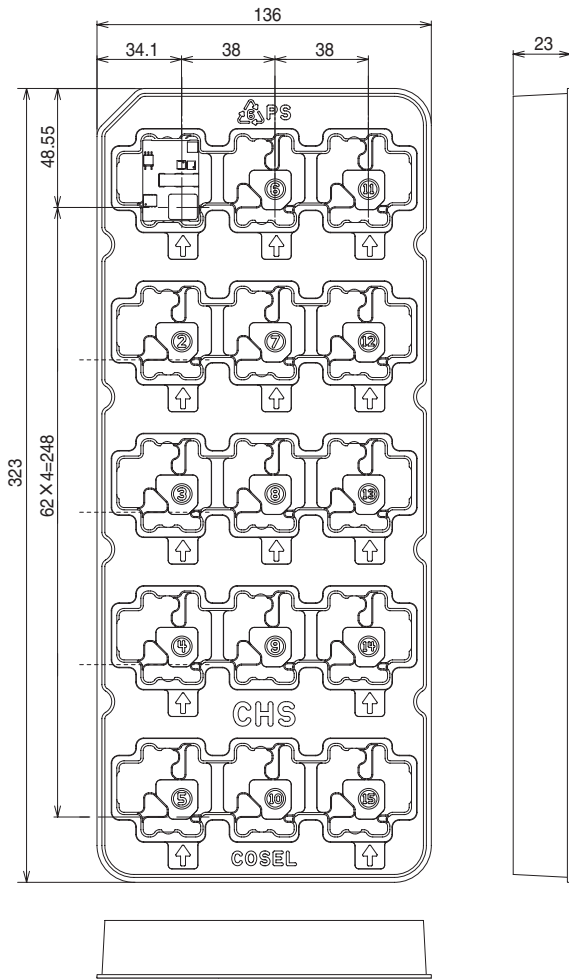

Dimensions in mm
Material : Conductive PS

Fig.9.2 Delivery package information (CHS80)

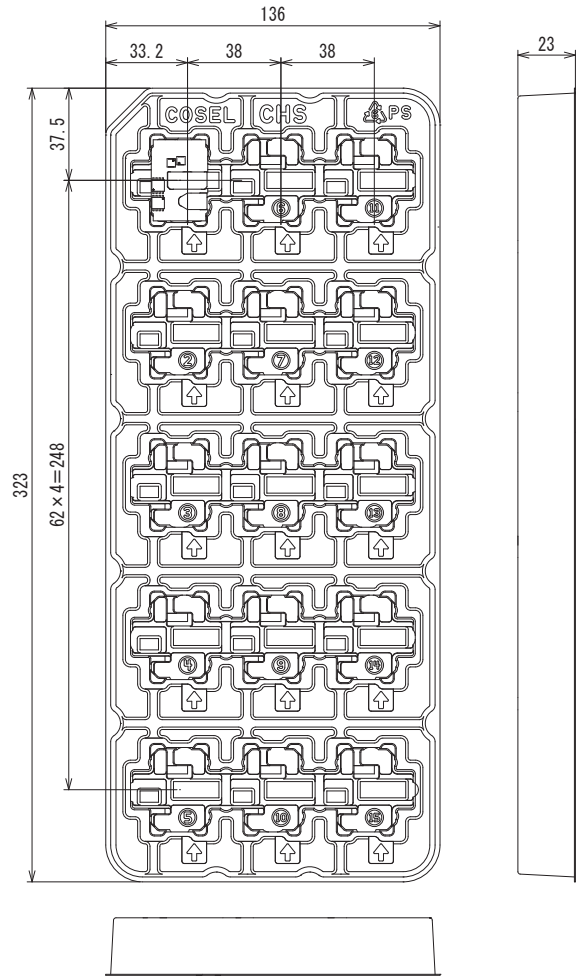

Dimensions in mm
Material : Conductive PS

Fig.9.3 Delivery package information (CHS120)