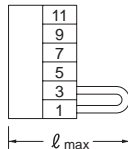
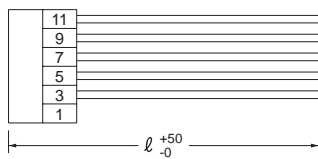
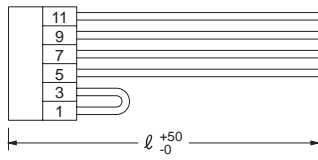

Harness to use the function of the output module is prepared in MAX series.

MAX Series

Mating harness

Model	Harness model #	Contents
MAX1600F	H-SN-3	Harness for using no function of the output module. It is appended to standard model.
MAX1600T	H-SN-4	Harness for using all functions of output module.
MAX3200T	H-SN-6	Harness for using all functions except remote sensing of the output module.

<p>●Model number</p> <h2>H-SN-3</h2> <p>Housing : PHDR-12VS (J.S.T.) Pin : SPHD-002T-P0.5 (J.S.T.)</p>	<p>●Type</p> 	<p>●Wire</p> <table border="1"> <thead> <tr> <th>Pin #</th> <th>Wire</th> <th>AWG</th> <th>Color</th> <th>Length ℓ (mm)</th> </tr> </thead> <tbody> <tr><td>1</td><td>UL1061</td><td>28</td><td>red</td><td>30</td></tr> <tr><td>2</td><td>UL1061</td><td>28</td><td>black</td><td>30</td></tr> <tr><td>3</td><td>UL1061</td><td>28</td><td>red</td><td>30</td></tr> <tr><td>4</td><td>UL1061</td><td>28</td><td>black</td><td>30</td></tr> <tr><td>5</td><td>-</td><td>-</td><td>-</td><td>-</td></tr> <tr><td>6</td><td>-</td><td>-</td><td>-</td><td>-</td></tr> <tr><td>7</td><td>-</td><td>-</td><td>-</td><td>-</td></tr> <tr><td>8</td><td>-</td><td>-</td><td>-</td><td>-</td></tr> <tr><td>9</td><td>-</td><td>-</td><td>-</td><td>-</td></tr> <tr><td>10</td><td>-</td><td>-</td><td>-</td><td>-</td></tr> <tr><td>11</td><td>-</td><td>-</td><td>-</td><td>-</td></tr> <tr><td>12</td><td>-</td><td>-</td><td>-</td><td>-</td></tr> </tbody> </table>	Pin #	Wire	AWG	Color	Length ℓ (mm)	1	UL1061	28	red	30	2	UL1061	28	black	30	3	UL1061	28	red	30	4	UL1061	28	black	30	5	-	-	-	-	6	-	-	-	-	7	-	-	-	-	8	-	-	-	-	9	-	-	-	-	10	-	-	-	-	11	-	-	-	-	12	-	-	-	-
Pin #	Wire	AWG	Color	Length ℓ (mm)																																																															
1	UL1061	28	red	30																																																															
2	UL1061	28	black	30																																																															
3	UL1061	28	red	30																																																															
4	UL1061	28	black	30																																																															
5	-	-	-	-																																																															
6	-	-	-	-																																																															
7	-	-	-	-																																																															
8	-	-	-	-																																																															
9	-	-	-	-																																																															
10	-	-	-	-																																																															
11	-	-	-	-																																																															
12	-	-	-	-																																																															
<p>●Model number</p> <h2>H-SN-4</h2> <p>Housing : PHDR-12VS (J.S.T.) Pin : SPHD-002T-P0.5 (J.S.T.)</p>	<p>●Type</p> 	<p>●Wire</p> <table border="1"> <thead> <tr> <th>Pin #</th> <th>Wire</th> <th>AWG</th> <th>Color</th> <th>Length ℓ (mm)</th> </tr> </thead> <tbody> <tr><td>1</td><td>-</td><td>-</td><td>-</td><td>-</td></tr> <tr><td>2</td><td>-</td><td>-</td><td>-</td><td>-</td></tr> <tr><td>3</td><td>UL1061</td><td>28</td><td>red</td><td>500</td></tr> <tr><td>4</td><td>UL1061</td><td>28</td><td>black</td><td>500</td></tr> <tr><td>5</td><td>UL1061</td><td>28</td><td>brown</td><td>500</td></tr> <tr><td>6</td><td>UL1061</td><td>28</td><td>black</td><td>500</td></tr> <tr><td>7</td><td>UL1061</td><td>28</td><td>orange</td><td>500</td></tr> <tr><td>8</td><td>UL1061</td><td>28</td><td>black</td><td>500</td></tr> <tr><td>9</td><td>UL1061</td><td>28</td><td>yellow</td><td>500</td></tr> <tr><td>10</td><td>UL1061</td><td>28</td><td>green</td><td>500</td></tr> <tr><td>11</td><td>UL1061</td><td>28</td><td>blue</td><td>500</td></tr> <tr><td>12</td><td>UL1061</td><td>28</td><td>purple</td><td>500</td></tr> </tbody> </table>	Pin #	Wire	AWG	Color	Length ℓ (mm)	1	-	-	-	-	2	-	-	-	-	3	UL1061	28	red	500	4	UL1061	28	black	500	5	UL1061	28	brown	500	6	UL1061	28	black	500	7	UL1061	28	orange	500	8	UL1061	28	black	500	9	UL1061	28	yellow	500	10	UL1061	28	green	500	11	UL1061	28	blue	500	12	UL1061	28	purple	500
Pin #	Wire	AWG	Color	Length ℓ (mm)																																																															
1	-	-	-	-																																																															
2	-	-	-	-																																																															
3	UL1061	28	red	500																																																															
4	UL1061	28	black	500																																																															
5	UL1061	28	brown	500																																																															
6	UL1061	28	black	500																																																															
7	UL1061	28	orange	500																																																															
8	UL1061	28	black	500																																																															
9	UL1061	28	yellow	500																																																															
10	UL1061	28	green	500																																																															
11	UL1061	28	blue	500																																																															
12	UL1061	28	purple	500																																																															
<p>●Model number</p> <h2>H-SN-6</h2> <p>Housing : PHDR-12VS (J.S.T.) Pin : SPHD-002T-P0.5 (J.S.T.)</p>	<p>●Type</p> 	<p>●Wire</p> <table border="1"> <thead> <tr> <th>Pin #</th> <th>Wire</th> <th>AWG</th> <th>Color</th> <th>Length ℓ (mm)</th> </tr> </thead> <tbody> <tr><td>1</td><td>UL1061</td><td>28</td><td>red</td><td>30</td></tr> <tr><td>2</td><td>UL1061</td><td>28</td><td>black</td><td>30</td></tr> <tr><td>3</td><td>UL1061</td><td>28</td><td>red</td><td>30</td></tr> <tr><td>4</td><td>UL1061</td><td>28</td><td>black</td><td>30</td></tr> <tr><td>5</td><td>UL1061</td><td>28</td><td>brown</td><td>500</td></tr> <tr><td>6</td><td>UL1061</td><td>28</td><td>black</td><td>500</td></tr> <tr><td>7</td><td>UL1061</td><td>28</td><td>orange</td><td>500</td></tr> <tr><td>8</td><td>UL1061</td><td>28</td><td>black</td><td>500</td></tr> <tr><td>9</td><td>UL1061</td><td>28</td><td>yellow</td><td>500</td></tr> <tr><td>10</td><td>UL1061</td><td>28</td><td>green</td><td>500</td></tr> <tr><td>11</td><td>UL1061</td><td>28</td><td>blue</td><td>500</td></tr> <tr><td>12</td><td>UL1061</td><td>28</td><td>purple</td><td>500</td></tr> </tbody> </table>	Pin #	Wire	AWG	Color	Length ℓ (mm)	1	UL1061	28	red	30	2	UL1061	28	black	30	3	UL1061	28	red	30	4	UL1061	28	black	30	5	UL1061	28	brown	500	6	UL1061	28	black	500	7	UL1061	28	orange	500	8	UL1061	28	black	500	9	UL1061	28	yellow	500	10	UL1061	28	green	500	11	UL1061	28	blue	500	12	UL1061	28	purple	500
Pin #	Wire	AWG	Color	Length ℓ (mm)																																																															
1	UL1061	28	red	30																																																															
2	UL1061	28	black	30																																																															
3	UL1061	28	red	30																																																															
4	UL1061	28	black	30																																																															
5	UL1061	28	brown	500																																																															
6	UL1061	28	black	500																																																															
7	UL1061	28	orange	500																																																															
8	UL1061	28	black	500																																																															
9	UL1061	28	yellow	500																																																															
10	UL1061	28	green	500																																																															
11	UL1061	28	blue	500																																																															
12	UL1061	28	purple	500																																																															

* The even number pin side of the connector is the same wiring as the odd number pin side.

Terminal Attachment

Terminal attachment to facilitate two or more terminal connections to power supply output is prepared in PAA, UAW, UAF, MAX and ACE series.

Type	Mating Model	Contents
B-PAA600-1	PAA300 PAA600 UAW500 UAF500	Terminal attachment to facilitate two or more terminal connections to power supply output
B-MX-1	PBA600F MAX1600F MAX1600T MAX3200T	Terminal attachment to facilitate terminal connections to power supply output
B-MX-9	MAX1600F MAX1600T MAX3200T	Terminal attachment for series operation as output modules

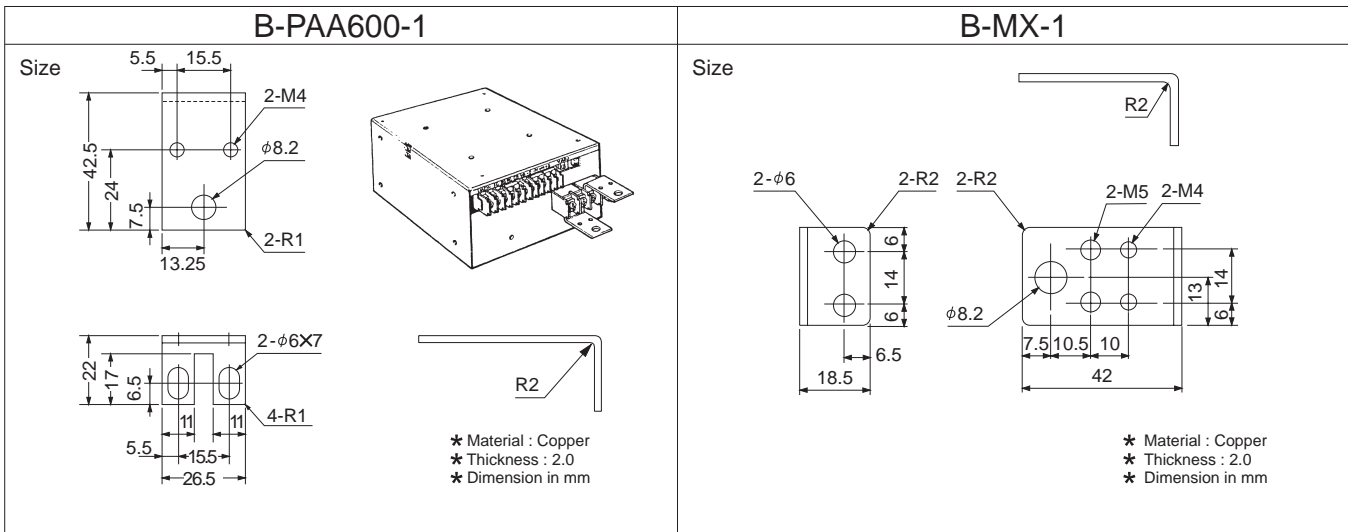

* It is necessary to install the attachments on opposite direction to avoid short-circuit between + and - in terminal block.

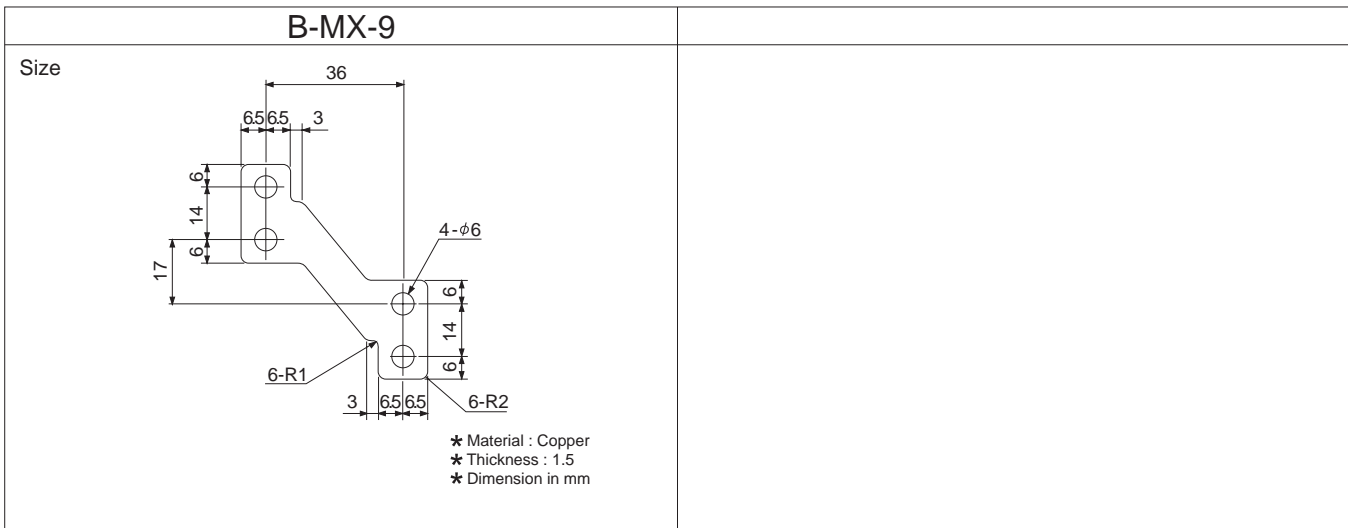

* It is necessary to install B-MX-1 on opposite direction to avoid short-circuit between + and - terminal block.

* Please note the direction of the installation to prevent the short-circuit between the outputs when using B-MX-1 and B-MX-9 at the same time.

* The cover of terminal block does not be attached to B-MX-1 with installation screw and solderless terminal occasionally.

Fan unit

★ Fan unit is prepared by the option.

ACE Series MAX Series

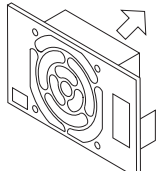
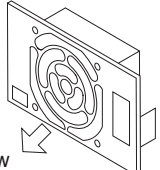
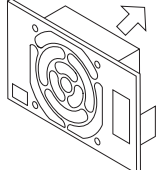
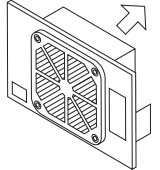
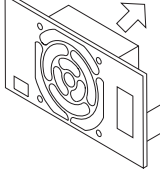
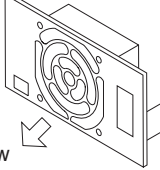
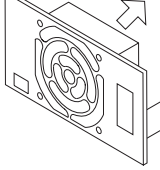
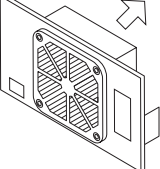
Fan unit type	Matching model	External	Pin connection								
FAN-AC3 (Standard)	ACE300F <Standard>		<p>CONNECTOR = XAP-03V-1 (Mfr : J. S. T) TERMINAL = SXA-001T-P0.6 (Mfr : J. S. T)</p> <table border="1"> <thead> <tr> <th>Pin No.</th> <th>Content</th> </tr> </thead> <tbody> <tr> <td>1</td> <td>GND</td> </tr> <tr> <td>2</td> <td>FAN ALARM</td> </tr> <tr> <td>3</td> <td>POWER</td> </tr> </tbody> </table> <p>LENGTH OF HARNESS = 60 ± 10mm</p>	Pin No.	Content	1	GND	2	FAN ALARM	3	POWER
Pin No.	Content										
1	GND										
2	FAN ALARM										
3	POWER										
FAN-AC3-F (Air flow reverse : -F)	ACE300F <Modification : F>										
FAN-AC3-K (Low speed : -K)	ACE300F <Modification : K>										
FAN-AC3-T (With filter : -T)	ACE300F <Modification : T>										
FAN-AC4 (Standard)	ACE450F ACE650F <Standard>		<p>CONNECTOR = XAP-03V-1 (Mfr : J. S. T) TERMINAL = SXA-001T-P0.6 (Mfr : J. S. T)</p> <table border="1"> <thead> <tr> <th>Pin No.</th> <th>Content</th> </tr> </thead> <tbody> <tr> <td>1</td> <td>GND</td> </tr> <tr> <td>2</td> <td>FAN ALARM</td> </tr> <tr> <td>3</td> <td>POWER</td> </tr> </tbody> </table> <p>LENGTH OF HARNESS = 55 ± 10mm</p>	Pin No.	Content	1	GND	2	FAN ALARM	3	POWER
Pin No.	Content										
1	GND										
2	FAN ALARM										
3	POWER										
FAN-AC4-F (Air flow reverse : -F)	ACE450F ACE650F <Modification : F>										
FAN-AC4-K (Low speed : -K)	ACE450F ACE650F <Modification : K>										
FAN-AC4-T (With filter : -T)	ACE450F ACE650F <Modification : T>										

★ 1 Handle with care and don't add the impact such as falls or throwing to the unit.

★ 2 Exchange the unit after intercepting the input power.

★ 3 When the unit is exchanged, make sure there are not loosening of the connector and shutting the harness.

Fan unit

★Fan unit is prepared by the option.

ACE Series MAX Series

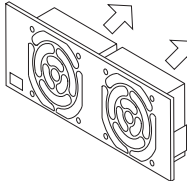
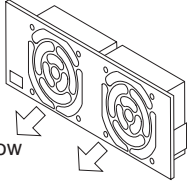
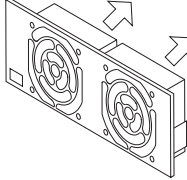
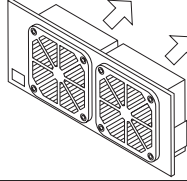
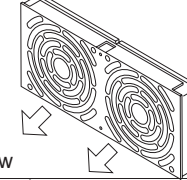
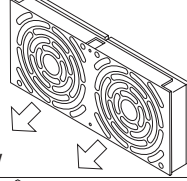
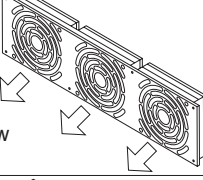
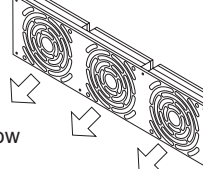
Fan unit type	Matching model	External	Pin connection								
FAN-AC9 (Standard)	ACE900F <Standard>		CONNECTOR = XAP-03V-1 (Mfr : J. S. T) TERMINAL = SXA-001T-P0.6 (Mfr : J. S. T) <table border="1" data-bbox="1246 749 1497 870"> <thead> <tr> <th>Pin No.</th> <th>Content</th> </tr> </thead> <tbody> <tr> <td>1</td> <td>GND</td> </tr> <tr> <td>2</td> <td>FAN ALARM</td> </tr> <tr> <td>3</td> <td>POWER</td> </tr> </tbody> </table> LENGTH OF HARNESS = 55 ± 10mm	Pin No.	Content	1	GND	2	FAN ALARM	3	POWER
Pin No.	Content										
1	GND										
2	FAN ALARM										
3	POWER										
FAN-AC9-F (Air flow reverse : -F)	ACE900F <Modification : F>										
FAN-AC9-K (Low speed : -K)	ACE900F <Modification : K>										
FAN-AC9-T (With filter : -T)	ACE900F <Modification : T>										
FAN-MA1 (Standard)	MAX1600F MAX1600T <Standard>		CONNECTOR = XHP-3 (Mfr : J. S. T) TERMINAL = SXH-001T-P0.6 (Mfr : J. S. T) <table border="1" data-bbox="1246 1508 1497 1630"> <thead> <tr> <th>Pin No.</th> <th>Content</th> </tr> </thead> <tbody> <tr> <td>1</td> <td>POWER</td> </tr> <tr> <td>2</td> <td>FAN ALARM</td> </tr> <tr> <td>3</td> <td>GND</td> </tr> </tbody> </table> LENGTH OF HARNESS = 210 ± 15mm	Pin No.	Content	1	POWER	2	FAN ALARM	3	GND
Pin No.	Content										
1	POWER										
2	FAN ALARM										
3	GND										
FAN-MA1-B (Long life : -B)	MAX1600F MAX1600T <Modification : B>										
FAN-MA3 (Standard)	MAX3200T <Standard>										
FAN-MA3-B (Long life : -B)	MAX3200T <Modification : B>										

- ★ 1 Handle with care and don't add the impact such as falls or throwing to the unit.
- ★ 2 Exchange the unit after intercepting the input power.
- ★ 3 When the unit is exchanged, make sure there are not loosening of the connector and shutting the harness.