

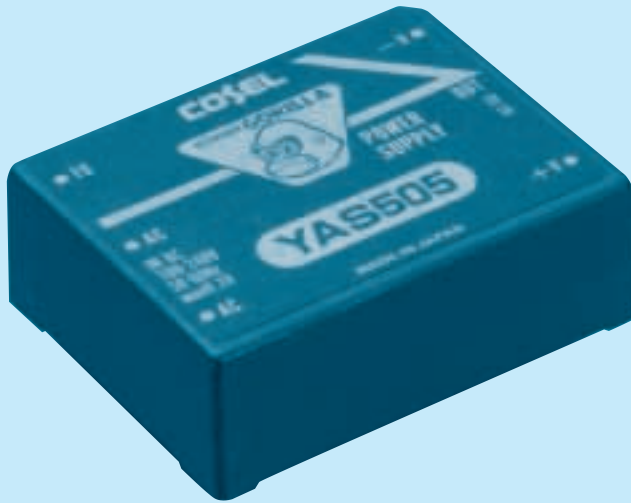

- ① Series name
- ② Single output
- ③ Output wattage
- ④ Output voltage
- ⑤ UL recognized, TÜV approved, CSA certified: E



MODEL	YAS505	YAS512
MAX OUTPUT WATTAGE[W]	5.0	5.4
DC OUTPUT	5V 1.0A	12V 0.45A

**SPECIFICATIONS**

	MODEL	YAS505	YAS512	
INPUT	VOLTAGE[V]	AC85 - 264 1 φ or DC110 - 370		
	CURRENT[A]	ACIN 200V	0.07typ (Io=100%)	
	FREQUENCY[Hz]	47 - 440 or DC		
	EFFICIENCY[%]	65typ	67typ	
	INRUSH CURRENT[A]	ACIN 100V	20typ (Io=100%)	
		ACIN 200V	40typ (Io=100%)	
OUTPUT	VOLTAGE[V]	5	12	
	CURRENT[A]	1	0.45	
	LINE REGULATION[mV]	20max	48max	
	LOAD REGULATION[mV]	40max	100max	
	RIPPLE[mVp-p]	*1 80max	120max	
	RIPPLE NOISE[mVp-p]	*1 120max	150max	
	TEMPERATURE REGULATION[mV]	0 to +55°C	50max	
	TEMPERATURE REGULATION[mV]	0 to +55°C	150max	
OUTPUT VOLTAGE ADJUSTMENT RANGE[V]	Fixed			
OUTPUT VOLTAGE SETTING[%]	±5max (Rated input/output, Ta=25°C)			
HOLD-UP TIME[ms]	10typ (ACIN 85V, Io=100%)			
PROTECTION CIRCUIT	OVERCURRENT PROTECTION	Works over 105% of rating and recovers automatically		
ISOLATION	INPUT-OUTPUT	AC3,000V 1minute, Cutoff current = 15mA, DC500V 50MΩmin (At Room Temperature)		
	INPUT-FG	AC2,000V 1minute, Cutoff current = 10mA, DC500V 50MΩmin (At Room Temperature)		
	OUTPUT-FG	AC500V 1minute, Cutoff current=100mA, DC500V 50MΩmin (At Room Temperature)		
ENVIRONMENT	OPERATING TEMP., HUMID. AND ALTITUDE	-10 to +70°C, 20 - 95%RH (Non condensing) (Refer to DERATING CURVE), 3,000m (10,000feet) max		
	STORAGE TEMP., HUMID. AND ALTITUDE	-20 to +75°C, 20 - 95%RH (Non condensing), 9,000m (30,000feet) max		
	VIBRATION	10 - 55Hz, 98.0m/s <sup>2</sup> (10G), 3minutes period, 60minutes each along X, Y and Z axis		
	IMPACT	490.3m/s <sup>2</sup> (50G), 11ms, once each X, Y and Z axis		
SAFETY AND NOISE REGULATIONS	AGENCY APPROVALS	UL60950-1, EN60950-1, EN50178, CSA C22.2 No.60950-1 Complies with IEC60950-1		
	CONDUCTED NOISE	Complies with FCC-B, VCCI-B, Additional capacitors required for meeting CISPR22-B, EN55022-B (External Fuse is required)		

\*1 Measured by 20MHz oscilloscope.  
\* Parallel operation with other model is not possible.

External view

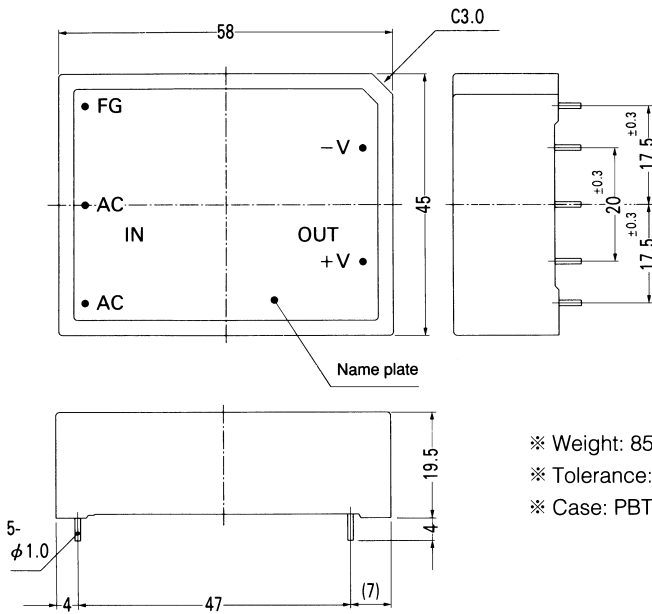

- ※ Weight: 85g or less
- ※ Tolerance:  $\pm 0.5$
- ※ Case: PBT

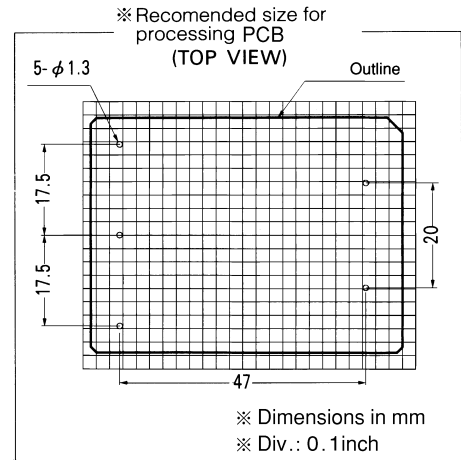

Performance data

■ STATIC CHARACTERISTICS (YAS512)

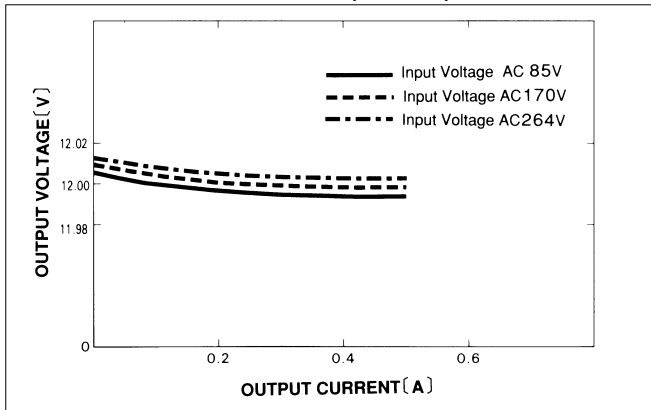

■ RISE TIME (YAS512)

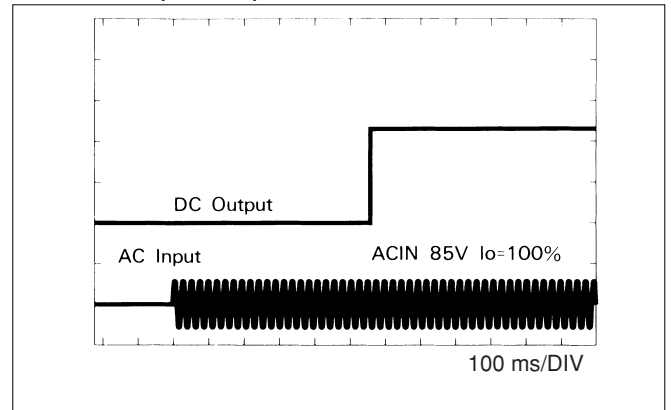

■ OVERCURRENT CHARACTERISTICS (YAS512)

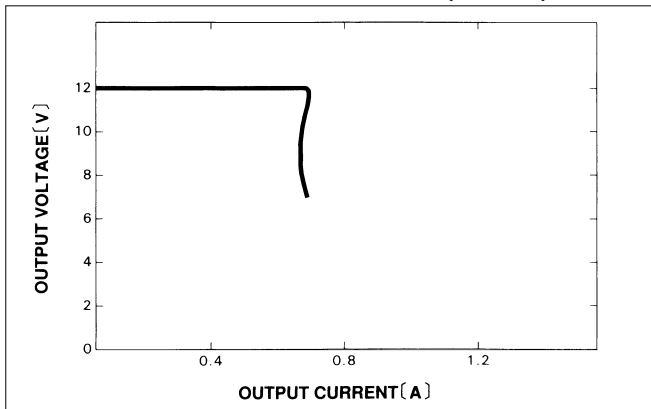

■ DERATING CURVE

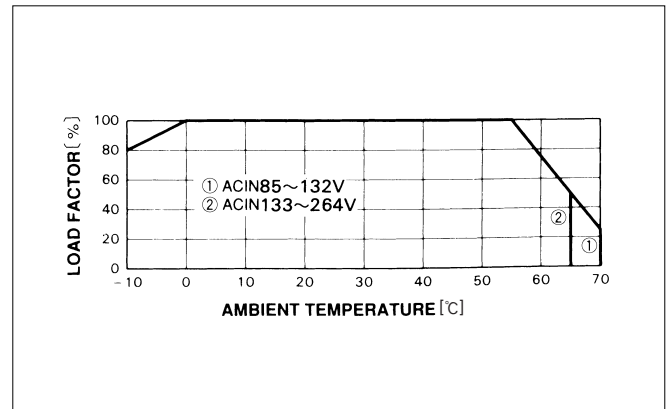

YA

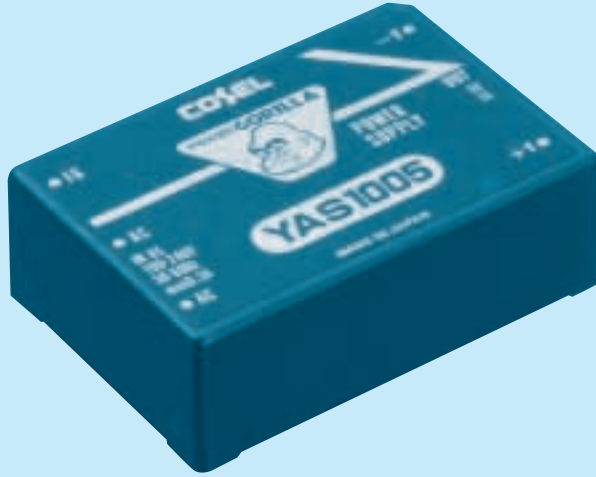

- ① Series name
- ② Single output
- ③ Output wattage
- ④ Output voltage
- ⑤ UL recognized, TÜV approved CSA certified: E

<b>MODEL</b>	<b>YAS1005</b>	<b>YAS1012</b>
<b>MAX OUTPUT WATTAGE[W]</b>	<b>10.0</b>	<b>10.8</b>
<b>DC OUTPUT</b>	<b>5V 2.0A</b>	<b>12V 0.9A</b>

**SPECIFICATIONS**

	MODEL	YAS1005	YAS1012	
<b>INPUT</b>	<b>VOLTAGE[V]</b>	AC85 - 264 1 φ or DC110 - 370		
	<b>CURRENT[A]</b>	ACIN 200V	0.14typ (Io=100%)	
	<b>FREQUENCY[Hz]</b>	47 - 440 or DC		
	<b>EFFICIENCY[%]</b>		70typ	
	<b>INRUSH CURRENT[A]</b>	ACIN 100V	20typ (Io=100%)	
		ACIN 200V	40typ (Io=100%)	
<b>OUTPUT</b>	<b>VOLTAGE[V]</b>	5	12	
	<b>CURRENT[A]</b>	2	0.9	
	<b>LINE REGULATION[mV]</b>	20max	48max	
	<b>LOAD REGULATION[mV]</b>	40max	100max	
	<b>RIPPLE[mVp-p]</b>	*1 80max	120max	
	<b>RIPPLE NOISE[mVp-p]</b>	*1 120max	150max	
	<b>TEMPERATURE REGULATION[mV]</b>	0 to +55°C	50max	
	<b>OUTPUT VOLTAGE ADJUSTMENT RANGE[V]</b>	Fixed		
<b>OUTPUT VOLTAGE SETTING[%]</b>	±5max (Rated input/output, Ta=25°C)			
<b>HOLD-UP TIME[ms]</b>	10typ (ACIN 85V, Io=100%)			
<b>PROTECTION CIRCUIT</b>	<b>OVERCURRENT PROTECTION</b>	Works over 105% of rating and recovers automatically		
<b>ISOLATION</b>	<b>INPUT-OUTPUT</b>	AC3,000V 1minute, Cutoff current = 15mA, DC500V 50MΩmin (At Room Temperature)		
	<b>INPUT-FG</b>	AC2,000V 1minute, Cutoff current = 10mA, DC500V 50MΩmin (At Room Temperature)		
	<b>OUTPUT-FG</b>	AC500V 1minute, Cutoff current=100mA, DC500V 50MΩmin (At Room Temperature)		
<b>ENVIRONMENT</b>	<b>OPERATING TEMP., HUMID. AND ALTITUDE</b>	-10 to +70°C, 20 - 95%RH (Non condensing) (Refer to DERATING CURVE), 3,000m (10,000feet) max		
	<b>STORAGE TEMP., HUMID. AND ALTITUDE</b>	-20 to +75°C, 20 - 95%RH (Non condensing), 9,000m (30,000feet) max		
	<b>VIBRATION</b>	10 - 55Hz, 98.0m/s <sup>2</sup> (10G), 3minutes period, 60minutes each along X, Y and Z axis		
	<b>IMPACT</b>	490.3m/s <sup>2</sup> (50G), 11ms, once each X, Y and Z axis		
<b>SAFETY AND NOISE REGULATIONS</b>	<b>AGENCY APPROVALS</b>	UL60950-1, EN60950-1, EN50178, CSA C22.2 No.60950-1 Complies with IEC60950-1		
	<b>CONDUCTED NOISE</b>	Complies with FCC-B, VCCI-B, Additional capacitors required for meeting CISPR22-B, EN55022-B (External Fuse is required)		

\*1 Measured by 20MHz oscilloscope.  
\* Parallel operation with other model is not possible.

External view

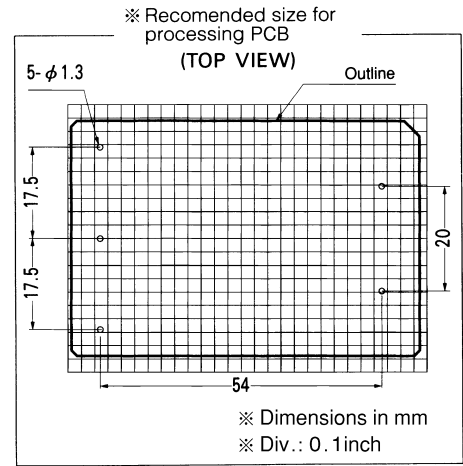
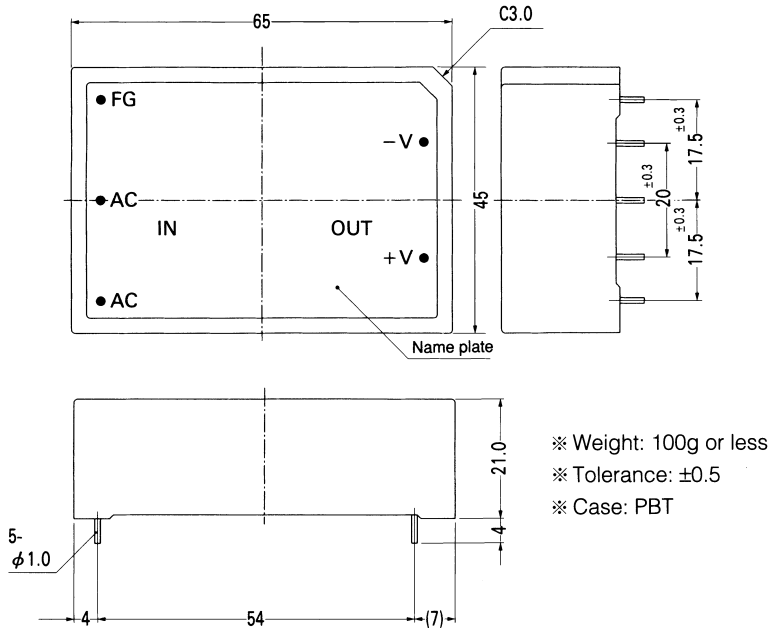

Performance data

STATIC CHARACTERISTICS (YAS1012)

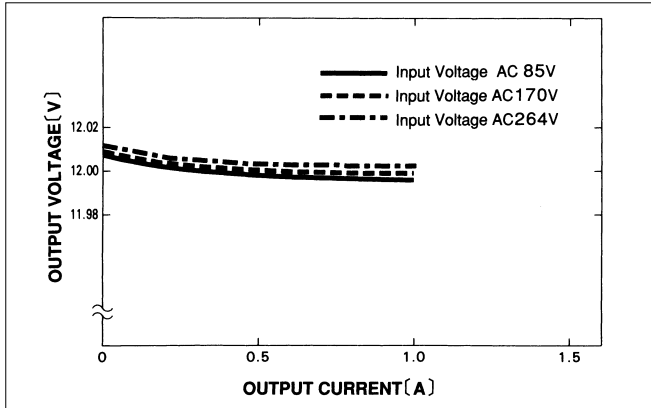

RISE TIME (YAS1012)

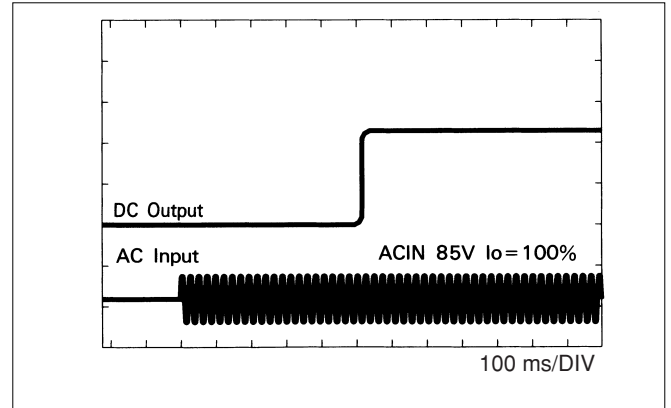

OVERCURRENT CHARACTERISTICS (YAS1012)

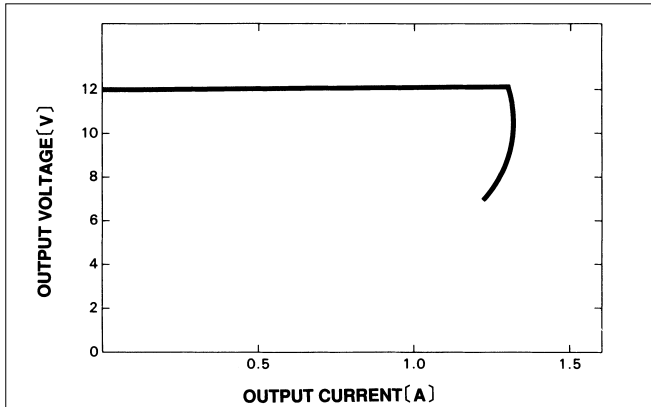

DERATING CURVE

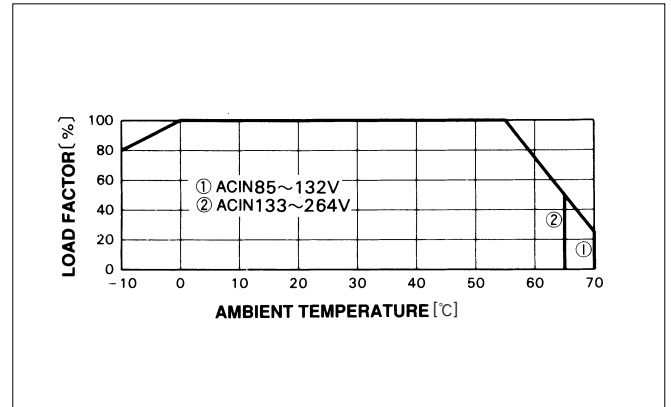

YA