

Basic Characteristics Data

Model	Circuit method	Switching frequency [kHz]	Input current *1 [A]	Rated input fuse	Inrush current protection	PCB/Pattern			Series/Parallel operation availability	
						Material	Single sided	Double sided	Series operation	Parallel operation
VAF5	Flyback converter	100	0.15	250V 2A	Resistor	CEM-3	Yes		Yes	*2
VAF10	Flyback converter	100	0.3	250V 2A	Resistor	CEM-3	Yes		Yes	*2

*1 The value of input current is at ACIN 100V and rated load.

*2 Refer to Instruction Manual.

1	Pin Connection	VAF-8
2	Function	VAF-8
2.1	Input voltage range	VAF-8
2.2	Inrush current limiting	VAF-8
2.3	Peak current	VAF-8
2.4	Overcurrent protection	VAF-8
2.5	Overvoltage protection	VAF-8
2.6	Thermal protection	VAF-8
2.7	Isolation	VAF-8
3	Wiring to Input/Output Pin	VAF-8
4	Series Operation and Parallel Operation	VAF-9
4.1	Series operation	VAF-9
4.2	Redundancy operation	VAF-9
5	Input Condition	VAF-9
6	Assembling and Installation Method	VAF-9
6.1	Installation method	VAF-9
6.2	Derating	VAF-10
7	Cleaning	VAF-10
8	Soldering	VAF-10
9	Input/Output Pin	VAF-10
10	Ground	VAF-10
11	Others	VAF-11

1 Pin Connection

No.	Pin connection	Function
①	AC(L)	Input pin AC85 - 264V 1ϕ 47 - 440Hz or DC110 - 370V
②	AC(N)	
③	FG	Frame ground
④	OUT +V	+Output
⑤	OUT -V	-Output

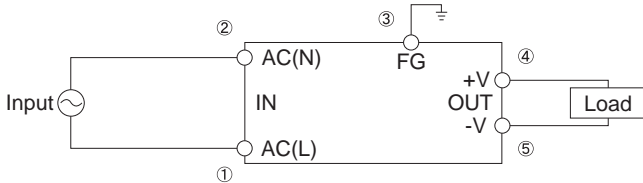

2 Function

2.1 Input voltage range

Input voltage range of the power supplies is from AC85-AC264V or DC110-DC370V. In cases that conform with safety standard, input voltage range is AC100-AC240V(50/60Hz).

2.2 Inrush current limiting

Inrush current limiting is built-in. If a switch on the input side is installed, it has to be the one handling the input inrush current.

2.3 Peak current

Fig.2.1 shows the available range of peak output current.

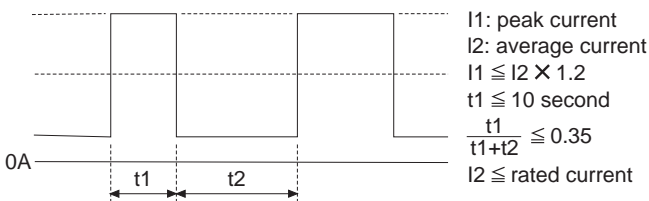

Fig.2.1 Peak current

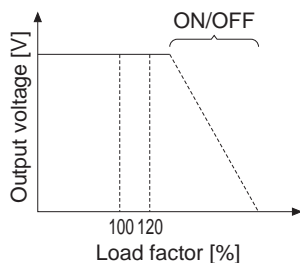

Fig.2.2 Overcurrent characteristics

2.4 Overcurrent protection

Overcurrent protection circuit is built-in to be operated over 125% of the rated current. Overcurrent protection prevents the unit from short circuit and over current condition. The unit automatically recovers when the fault condition is cleared.

2.5 Overvoltage protection

Overvoltage protection circuit, clamping the output voltage by zener diode, is built-in comes into effect at over 115% of the rated voltage. (For 3V type, overvoltage protection kicks in at over 4V.) The unit in an overvoltage protection mode cannot be recovered by a user, it must be repaired at the factory. Overvoltage protection (diode) also comes into effect if the voltage is externally applied to the output side. Avoid applying voltage to the output side.

2.6 Thermal protection

Thermal protection is built-in. If this function comes into effect, shut down the output, eliminate all possible cause of overheating, and drop the temperature to normal level. Output voltage recovers after applying input voltage. To prevent the unit from overheating, avoid using the unit in a dusty, poorly ventilated environment.

2.7 Isolation

For a receiving inspection, such as Hi-Pot test, gradually increase (decrease) the voltage for the start (shut down). Avoid using Hi-Pot tester with the timer because it may generate voltage a few times higher than the applied voltage, at ON/OFF of a timer.

3 Wiring to Input/ Output Pin

To decrease output ripple voltage more, install external capacitor C_o at output terminal as below.

Table 3.1 Capacity of external capacitor at output terminal: C_o [μ F]

Output voltage C_o	3.3V/5V	12V/15V	24V
Recommended value	220	100	47
Maximum value	2,200	1,000	470

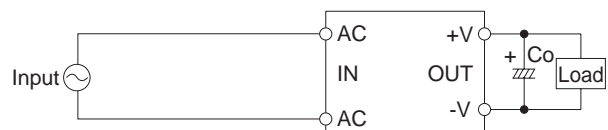
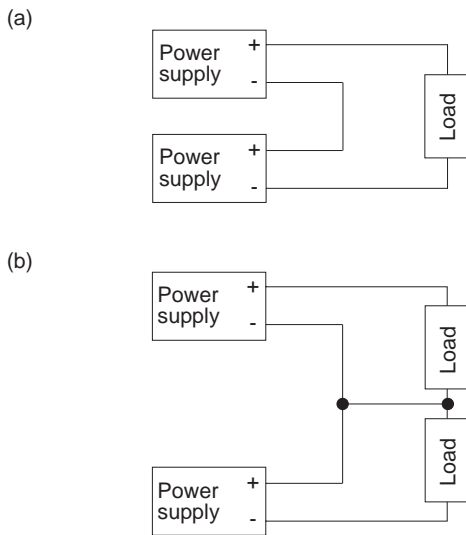

Fig.3.1 Connecting method of external capacitor at output terminal

4 Series Operation and Parallel Operation

4.1 Series operation

■Series operation is available by connecting the output of two or more power supplies, as shown below. Output current in series connection should be lower than the lowest rated in each unit.



4.2 Redundancy operation

■Redundancy operation is available by connecting the unit as shown below.

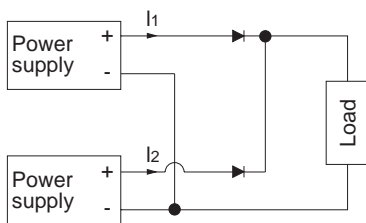

5 Input Condition

Following should be prohibited to avoid failure or malfunction.

- To continuously apply other than rated input voltage.
- To install the phase advance capacitor. (High voltage is generated when the input voltage is ON/OFF.)
- To apply input voltage less than AC60V.
 (It makes output voltage turn on/off one after another in short period of time. This malfunction is also caused by installing a switch/SSR with a capacitor on input line.)
- To apply square waveform input voltage, which is commonly used in UPS and Inverter.

6 Assembling and Installation Method

VAF

6.1 Installation method

■When two or more power supplies are used side by side, position them with proper intervals to allow enough air ventilation. Ambient temperature around each power supply should not exceed the temperature range shown in derating curve.

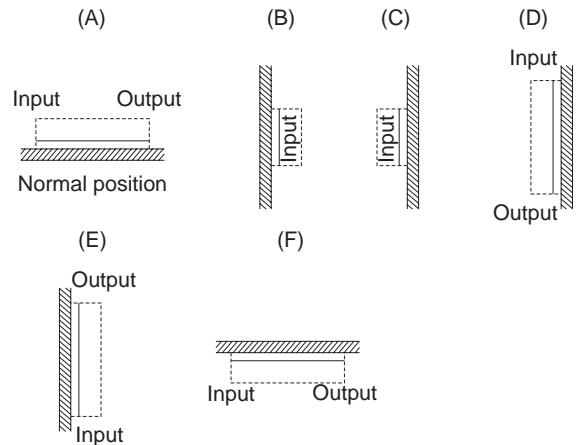

- When installing the components (inclusive chassis) or pattern which is a foreign potentials around the unit, keep the distance for more than 5mm. If this distance can not be kept, insert the insulation sheet between them.
- Avoid placing the AC input line pattern lay out underneath the unit as it will increase the line conducted noise. Make sure to leave an ample distance between the line pattern lay out and the unit. Also, avoid placing the DC output line pattern underneath the unit because it may increase the output noise. Lay out the pattern away from the unit.

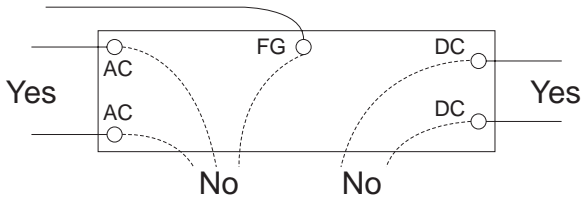

6.2 Derating

When unit mounted except below drawings, it is required to consider ventilated environment by forced air cooling for temperature/load derating. For details, please consult our sales or engineering departments.

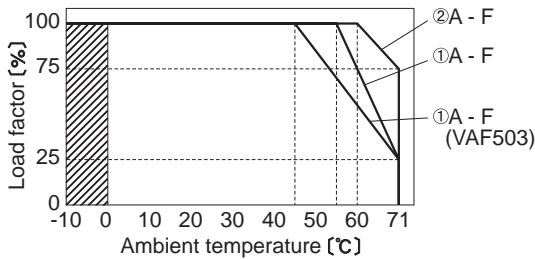

Fig.6.1 VAF5 Derating curve

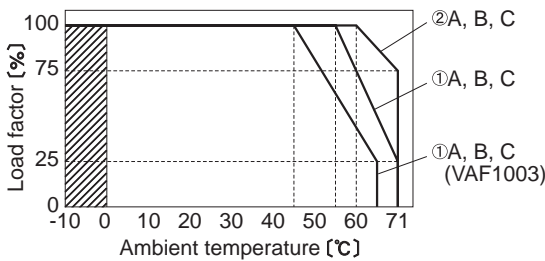

Fig.6.2 VAF10 Derating curve

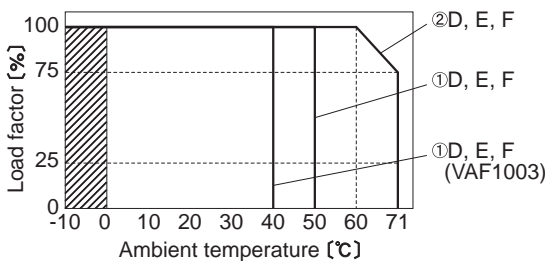

Fig.6.3 VAF10 Derating curve

- ① Convection
- ② Forced Air(0.5m³/min)

In case ②, ventilation must keep the temperature of C16 below 80°C. Refer to External View for the location of C16.

Note:

In the hatched area, the specification of Ripple, Ripple Noise are different from the other.

7 Cleaning

- Cleaning agents: IPA (Solvent type)
- Cleaning period : When cleaning the unit, the unit must be washed with a brush, and IPA must be kept out of the unit.
- After cleaning, dry them enough.

8 Soldering

- Dip soldering : 260°C less than 10 seconds.
- Soldering iron : 350°C less than 3 seconds.

9 Input/Output Pin

- When too much stress is applied on the input/output pins of the unit, the internal connection may be weakened. As below Fig.9.1, avoid applying stress of more than 9.8N (1kgf) on the pins horizontally and more than 19.6N (2kgf) vertically.
- The input/output pins are soldered on PCB internally, therefore, do not pull or bend them with abnormal forces.
- When additional stress is expected to be put on the input/output pins because of vibration or impacts, fix the unit on PCB (using silicone rubber or fixing fittings) to reduce the stress onto the input/output pins.

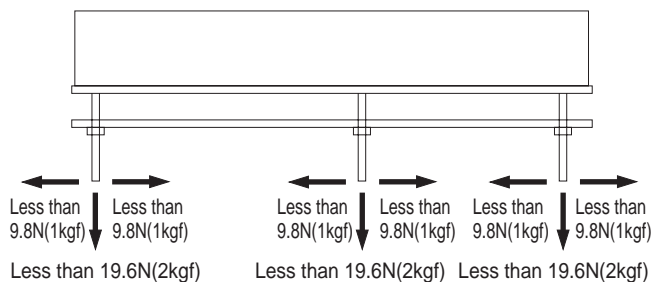

Fig.9.1 Stress on to the pins

10 Ground

- When installing the power supply with your unit, ensure that the input FG terminal is connected to safety ground of the unit. However, when applying the safety agency, connect the input FG terminal to safety ground of the unit.

11 Others

- This power supply is rugged PCB. Do not drop conductive object in the power supply.
- At light load, there remains high voltage inside the power supply for a few minutes after power OFF. So at maintenance, take care about electric shock.
- This power supply is manufactured by SMD technology. The stress to PCB like twisting or bending causes the defect of the unit, so handle the unit with care.