

Basic Characteristics Data

Model	Circuit method	Switching frequency [kHz]	Input current [A]	Rated input fuse	Inrush current protection	PCB/Pattern			Series/Parallel operation availability	
						Material	Single sided	Double sided	Series operation	Parallel operation
UAF500S	Active filter	200	6.8	250V 16A	SCR	FR-4		Yes	Yes	Yes
	Forward converter	170								

* The value of input current is at ACIN 100V and rated load.

1 Terminal Block UAF-6**2** Function UAF-6

2.1	Input voltage range	UAF-6
2.2	Inrush current limiting	UAF-6
2.3	Overcurrent protection	UAF-6
2.4	Overvoltage protection	UAF-6
2.5	Output voltage adjustment range	UAF-6
2.6	Remote sensing	UAF-6
2.7	Isolation	UAF-7
2.8	Thermal protection	UAF-7

3 Series Operation and Parallel Operation UAF-7**4** Assembling and Installation Method UAF-8

4.1	Installation method	UAF-8
4.2	Derating	UAF-8
4.3	Mounting screw	UAF-9
4.4	Others	UAF-9

1 Terminal Block

UAF

UAF500S

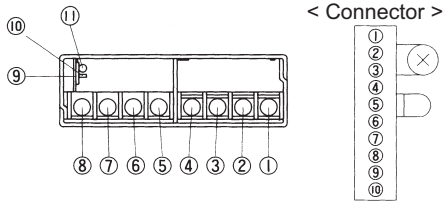

- ① AC(L)
- ② AC(N)
- ③ NC
- ④ Frame ground
- ⑤ } +Output
- ⑥ }
- ⑦ } -Output
- ⑧ }
- ⑨ Connector
- ⑩ LED
- ⑪ Output voltage adjustable potentiometer

< Connector >

Pin No.	Function
①	Connection is not possible.
②	Connection is not possible.
③	Connection is not possible.
④	Self sensing terminal.(Do not wire for external connection.)(-M)
⑤	-Remote sensing(-S)
⑥	Self sensing terminal.(Do not wire for external connection.)(+M)
⑦	Connection is not possible.
⑧	+Remote sensing(+S)
⑨	Voltage balance(VB)
⑩	Current balance(CB)

2 Function

2.1 Input voltage range

- The range is from AC85V to AC264V.
- AC input voltage must have a range from AC85V to AC264V for normal operation. If the wrong input is applied, the unit will not operate properly and/or may be damaged.
- In cases that conform with safety standard, input voltage range is AC100-AC240V(50/60Hz).

2.2 Inrush current limiting

- Inrush current limiting is built-in.
- If a switch on the input side is installed, it has to be the one handling the input inrush current.
- The thyristor technique is used for protection from inrush current. When power is turned ON/OFF repeatedly within a short period of time, it is necessary to have enough time between power ON and OFF to operate resistance circuit for inrush current.

2.3 Overcurrent protection

- The overcurrent protection circuit is built-in to prevent the unit from a short circuit and overcurrent condition. The unit automatically recovers when the fault condition is cleared.
- If the output voltage drops more than 50% of the rated voltage in an overcurrent protection mode, the average current will also be reduced by the intermittent operation.

2.4 Overvoltage protection

- The overvoltage protection circuit is built-in and comes into effect at 115 - 140% of the rated voltage. The AC input should be shut down if overvoltage protection is in operation. The minimum interval of AC recycling for recovery is 5 minutes.
- ★ The recovery time varies depending on input voltage.

Remarks:

Please avoid applying the over-rated voltage to the output terminal. Power supply may operate incorrectly or fail. In case of operating a motor etc., please install an external diode on the output terminal to protect the unit.

2.5 Output voltage adjustment range

- Adjustment of output voltage is possible by using potentiometer.
- Output voltage is increased by turning potentiometer clockwise and is decreased by turning potentiometer counterclockwise.

2.6 Remote sensing

(1)When not using remote sensing function

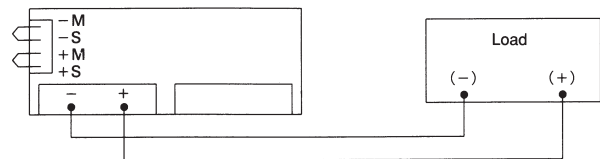

(2)When using remote sensing function

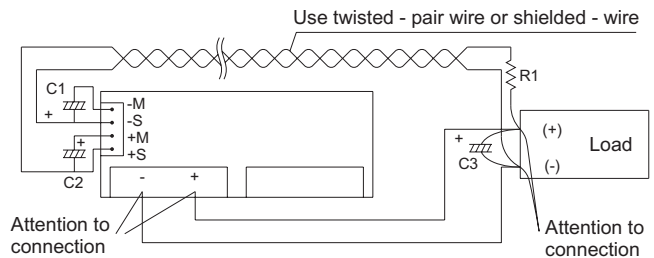

- When not using this function, confirm that terminals are shorted between +S and +M, and between -S and -M with short pieces.
- When using this function, wiring should be done without short pieces.
- Devices inside the power supply might be damaged when poor connection on load lines occurs, e.g. because of loose connector screws.
- Thick wire should be used for wiring between power supply and load, and line voltage drop should be less than 0.3V.
- When long sensing wire is required, use C1, C2 and C3.
- Twisted-pair wire or shield wire should be used for sensing wire.
- Please do not draw output current from +M, -M terminal.
- When remote sensing function is used, output voltage might become unstable because of a impedance of wiring and load condition. And the power supply should be evaluated enough. Following are examples to improve it.
 - * -S sensing wire is removed and terminals between -M and -S are shorted.
 - * C3 and R1 are connected as above figure.

2.7 Isolation

- For a receiving inspection, such as Hi-Pot test, gradually increase (decrease) the voltage for the start (shut down). Avoid using Hi-Pot tester with the timer because it may generate voltage a few times higher than the applied voltage, at ON/OFF of a timer.

2.8 Thermal protection

- Thermal protection is built-in. If this function comes into effect, shut down the output, eliminate all possible causes of overheating, and drop the temperature to normal level. Output voltage recovered after applying input voltage. To prevent the unit from overheating, avoid using the unit in a dusty, poorly ventilated environment.

3 Series Operation and Parallel Operation

- Series operation is available by connecting the outputs of two or more power supplies, as shown below. Output current in series connection should be lower than the lowest rated current in each unit.
- Parallel operation is available by connecting the units as shown below.

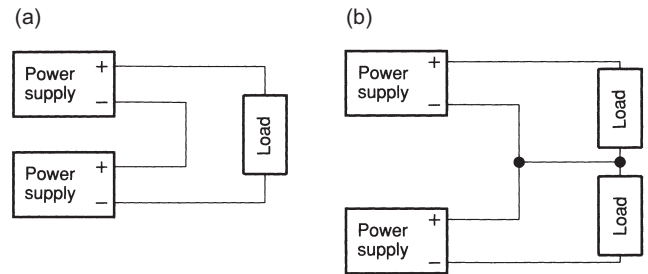

- As variance of output current drawn from each power supply is maximum 10%, the total output current must not exceed the value determined by the following equation.

(Output current at parallel operation)

$$= (\text{the rated current per unit}) \times (\text{number of unit}) \times 0.9$$

When the number of units in parallel operation increases, input current increases at the same time. Adequate wiring design for input circuitry is required, such as circuit pattern, wiring and current capacity for equipment.

In parallel operation, the maximum operative number of units is 5.

- Output voltage in parallel operation is adjustable by using the potentiometer of the "master" unit. Select one power supply to be the master, and turn the potentiometer of the other, "slave" power supplies, clockwise to the end. Then use the potentiometer of the master to adjust output voltage.
- When remote sensing is used in parallel operation, the sensing wire must be connected ONLY to the master. Terminals between +S&+M and -S&-M of "slave" power supplies must be shorted.

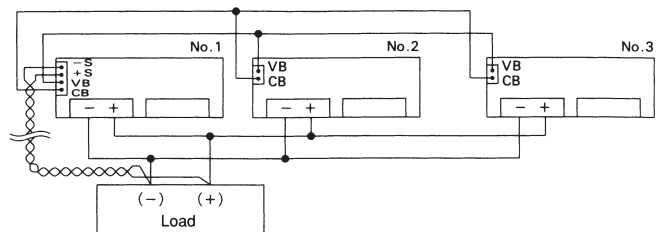

- In parallel operation, output voltage increases like stairs due to a delay of the rise time of output voltage at turn on.

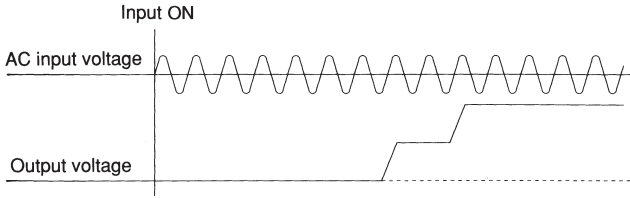

- In parallel operation, please connect diode to the +side of the output circuit. If diode is connected to the -side, it will damage the unit or/and the balancing function will not work.

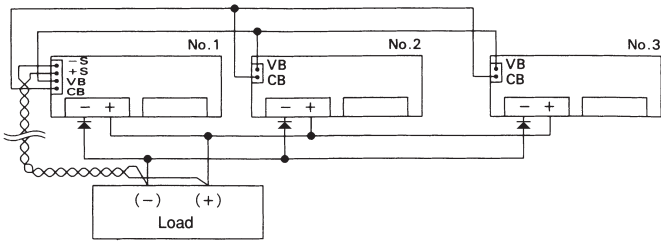

NO

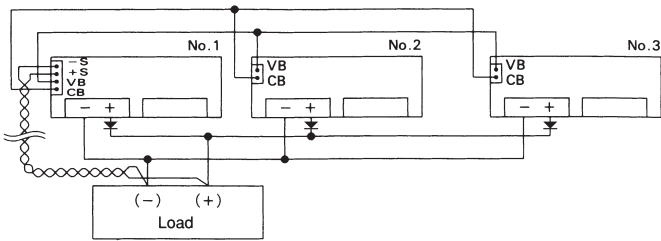

YES

4 Assembling and Installation Method

4.1 Installation method

- When two or more power supplies are used side by side, position them with proper intervals to allow enough air ventilation. Ambient temperature around each power supply should not exceed the temperature range shown in derating curve.

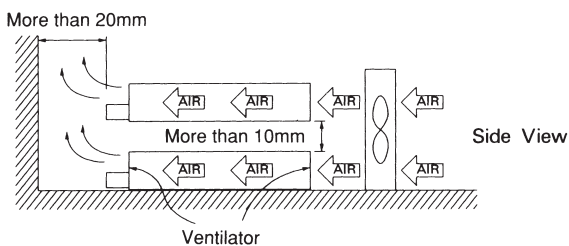

- Fan for forced air cooling is optional. Do not block the ventilation at suction side (terminal block side), its opposite side and upper side.
- When unit operates at dusty place, attach air-filter to avoid dust into the unit. In this case, avoid poorly ventilated environment.

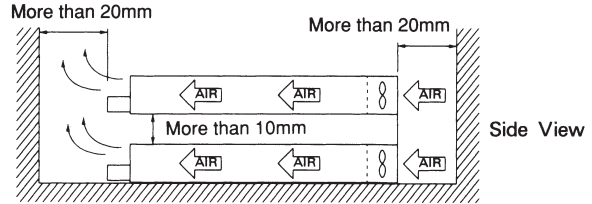

4.2 Derating

- When unit mounted except below drawings, it is required to consider ventilated environment by forced air cooling for temperature/load derating. For details, please consult our sales or engineering departments.

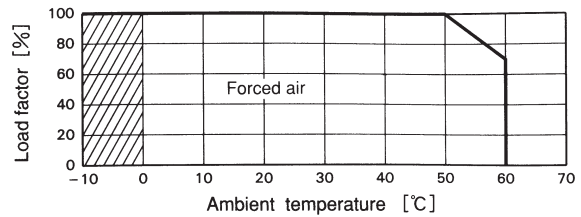
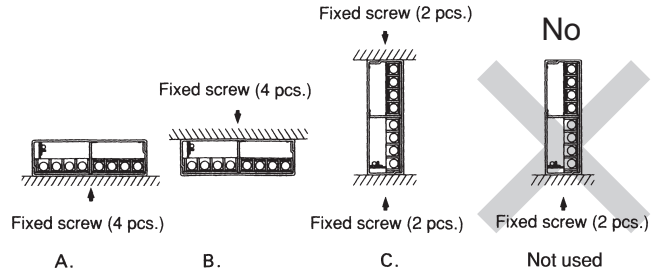

Note:

In the hatched area, the specification of Ripple, Ripple Noise is different from other area.

- When fan is set separately, the temperature of part A of the unit should be below 75 degree by flowing cooling-air inside of the unit.

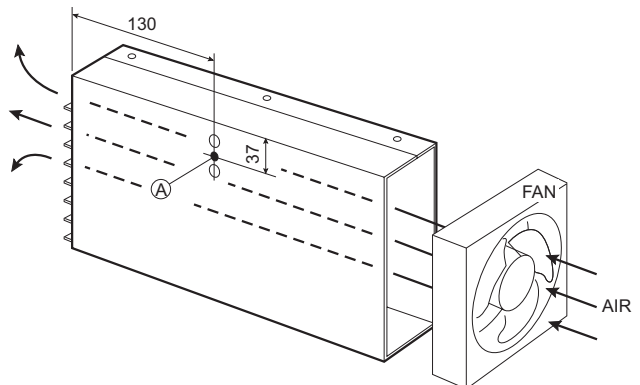

4.3 Mounting screw

■ Keep isolation distance between screw and internal components as below.

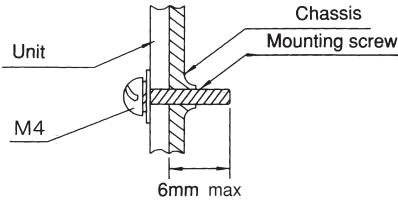

4.4 Others

■ Fan unit (Optional)

The power supply is designed to operate with the fan (forced air cooling). The optional external fan unit is listed in the following table.

Model	Model with fan unit	Fan unit
UAF500S- 3		
UAF500S- 5	UAF500S- 5-F	F500- 5
UAF500S-12	UAF500S-12-F	F500-12
UAF500S-24	UAF500S-24-F	F500-24
UAF500S-48		

* In case of unit with fan, the efficiency is lower 1% typ by power dissipation of fan.

The lifetime of fan varies depending on operating condition, so please replace the fan regularly.

