

<b>DATA SHEET</b>		Date	31-Oct-16
Model	TUXS200F32	Temp.	25 degreeC
Test	EMI Line conduction & Radiated emission	Humid.	40 %RH
		Tested by	T.Sodeno

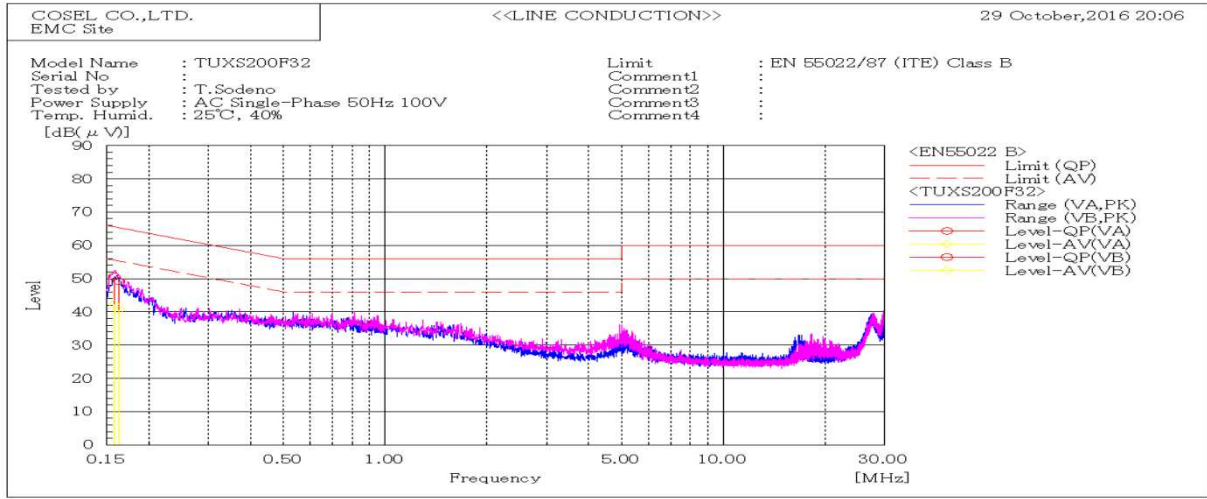

Frequency MHz	Line Phase	Level dB(uV)		Limit dB(uV)		Margin dB		Pass/Fail
		QP	AV	QP	AV	QP	AV	
0.15757	VB	50.6	42.3	65.6	55.6	15	13.3	Pass
0.16326	VA	49.2	40.6	65.3	55.3	16.1	14.7	Pass

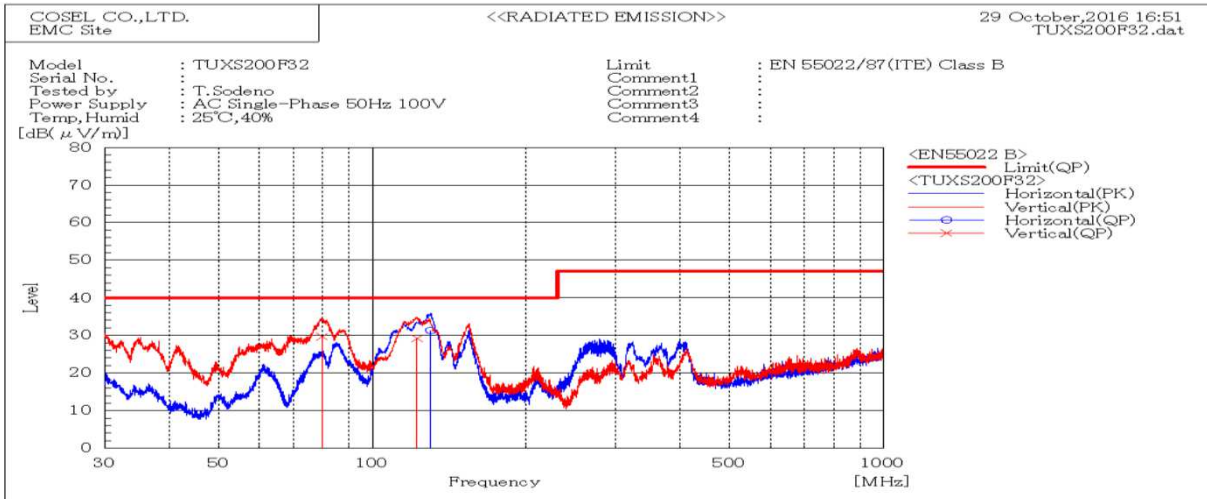

Frequency MHz	Polarization	Stability	Reading dB(uV)	Limit dB(uV/m)	Margin dB(uV/m)	Pass/Fail	Height cm	Angle deg
			QP	QP	QP			
79.595	V	Stable	29.8	40.0	10.2	Pass	110	253
122.114	V	Stable	29.2	40.0	10.8	Pass	100	279
130.006	H	Stable	31.3	40.0	8.7	Pass	153	194

DATA SHEET		Date	31-Oct-16
Model	Circuit used for measurement	Temp.	25 degreeC
Test	EMI	Humid.	40 %RH
	Line conduction & Radiated emission	Tested by	T.Sodeno

**1. Line conduction**

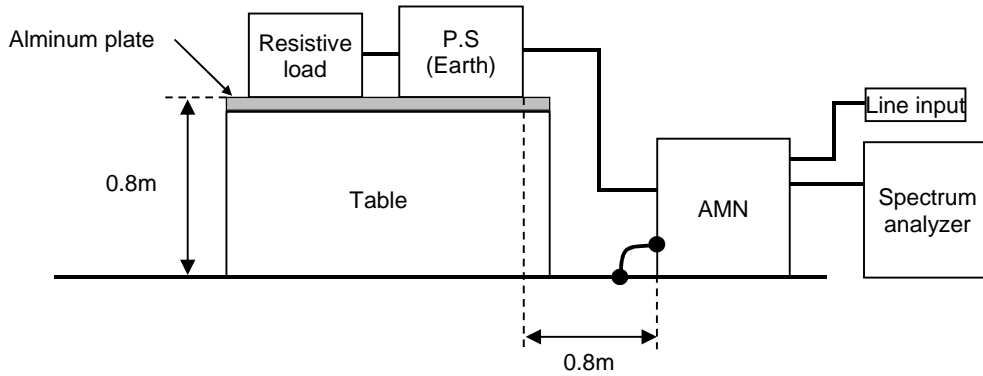

**2. Radiated emission**

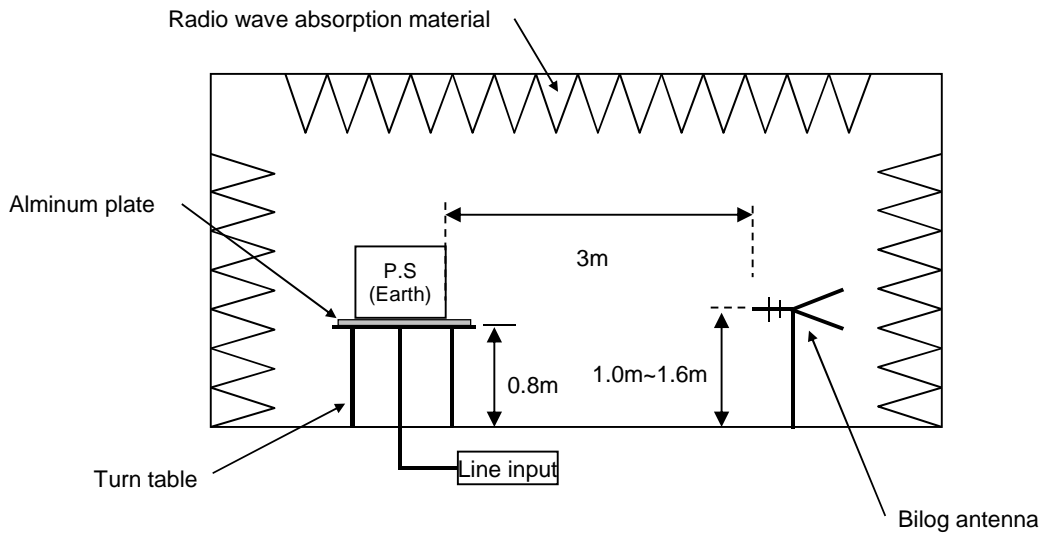

Test: EMI

Model Name:TUXS200F32

○ Photographs of Test Set-Up

LINE CONDUCTION

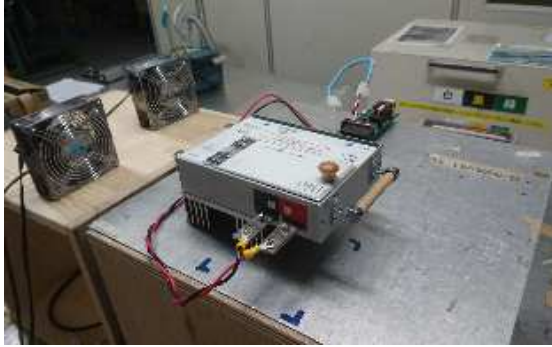

RADIATED EMISSION

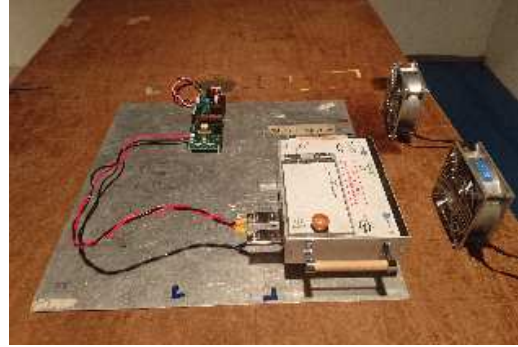

○ Test circuit

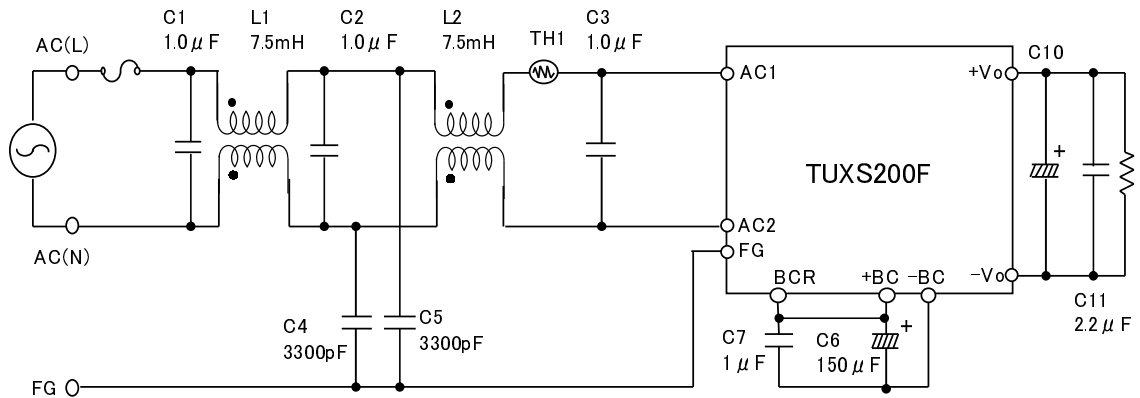

- L1,L2 : SCR22-060-1R0A075JH(NEC TOKIN)
- TH1 : 12D2-11LC(SEMITEC)
- C1,C2,C3 : LE105-MX(OKAYA)
- C4,C5 : DE1E3KX332M(MURATA)
- C6 : EKXJ421ELL151MM50S(Nippon Chemi-con)
- C7 : AFS450V105K(OKAYA)
- C10 : PCR1H181MCL1GS(NICHICON) × 3
- C11 : GRM31CR72A225K(MURATA)